



**TUFFSTUFF**  
FITNESS INTERNATIONAL



**SIX-PAK TRAINER**  
CABLE MOTION TECHNOLOGY

# Six-Pak Trainer . . . changing the

SPT-6X



## Traditional Cable Movements

## Stability Ball Training



Abdominal Crunch



Chest Fly



Outer Thigh



Ball Alternating Press



Ball Mid Row

# the shape of strength training!

SPT-6B

SPT-7



## Sports Specific Movements

## Pilates-Style Movements



Baseball Swing



Golf Swing

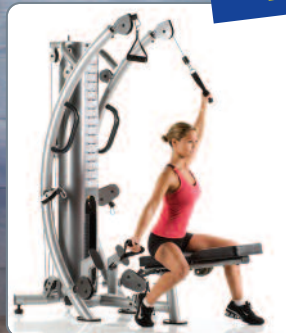

Forward Facing Swan



Kayak Row



Offer-Up

# SPT-6X

## SIX-PAK TRAINER

- The original patented, #1 selling Six-Pak Trainer.
- Compact, space efficient European-style design cable motion technology.
- 3" round 11-gauge tubular steel with a combination of 2x3" oval tubing and 2" round tubing.
- Two-tone powder coat finish – Platinum Sparkle and Ebony Chrome.
- Durable high density pads upholstered in black premium grade naugahyde.
- .094" USA-Made/Certified EXERFLEX PRO® high performance fitness cable.
- 200 lbs. steel weight stack.

**LIFETIME WARRANTY** – FOR HOME USE ONLY.



Unique 360° rotating bench easily adjusts to flat position.

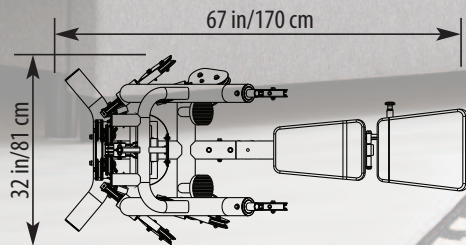

HT: 80 in/203 cm  
WT: 480 lb/218 kg

Quickly perform dozens of exercises and fitness routines without making any adjustments.



High Pulley Station



Mid Pulley Station



Low Pulley Station



High-Low Combinations



Optional Accessories

# SPT-6B

## BASE SIX-PAK TRAINER

- SPT-6X main frame combined with a V-shaped support designed to provide access for most size stability balls and benches.
- Open frame, allows unlimited full body training utilizing stability balls, balance boards, Bosu trainers, benches and ground based movements.
- 150 lbs. steel weight stack. (optional 200 lbs.)

**LIFETIME WARRANTY – FOR HOME USE ONLY.**

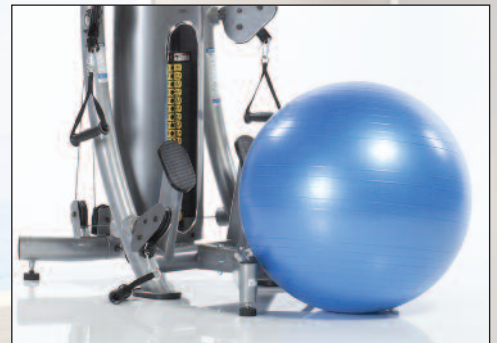

(Stability ball as shown is not included)

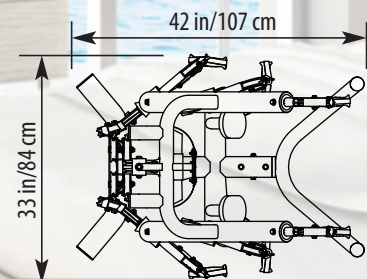

Height: 80 in/203 cm  
Weight: 400 lb/181 kg

**6 pre-set pulleys optimally positioned in three training zones, deliver dozens of full body exercises.**



High Pulley Station



Mid Pulley Station



Low Pulley Station



Stability Ball Workout



Customize Your Workout

# SPT-7

## LIGHT COMMERCIAL

- Free standing ultra compact cable motion technology with fixed extra long seat bench allows for various bench exercises.
- Ideal for hotels/motels, apartment complexes, personal training studios, fire & police stations and any facility that is not used by more than 30 people per day.
- Two-tone "tuck-n-roll" upholstery.
- 200 lbs. steel weight stack.

### LIGHT COMMERCIAL WARRANTY

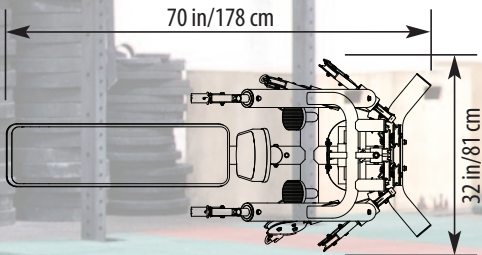

HT: 80 in/203 cm WT: 470 lb/213 kg

Ready-set-go, no adjustments needed – just select your desired resistance.



High Pulley Station



Mid Pulley Station



Low Pulley Station



Sit-Ups



One Arm Row

# HTX-2000

DUAL-STACK FUNCTIONAL TRAINER

HTX-2000 is the ideal choice for those facilities searching for a compact, easy-to-use strength training platform for their clients and guests. Basic SPT-6 frame structure with the addition of a seated leg extension/standing leg curl station not commonly found with other functional trainers.

(2) 200 lbs. steel weight stacks.

## LIGHT COMMERCIAL WARRANTY

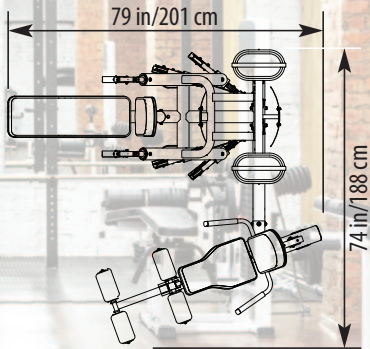

HT: 81 in/206 cm WT: 840 lb/381 kg

## IDEAL FOR:

- Hotels & Motels
- Corporate Wellness
- Fire & Police Departments
- Community Centers
- Private Studios
- Apartments & Condominiums
- Medical & Rehab Centers
- Personal Training Facilities.

Multiple user participation on two separate exercise stations in one machine.



Chest Press

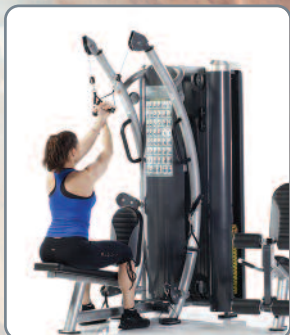

Lat Pulldown



Pectoral Crossover



Shoulder Press



Seated Leg Extension

# SPORTS SPECIFIC MOVEMENTS



SPT-6BB Baseball Bat Handle



SPT-6MH Multi-Use handle



SPT-6BA Baseball Accessory



SPT-6GH Golf Handle



SPT-6RA Rope Accessory



SPT-6SB Straight Bar



SPT-6AR Accessory Stand

Accessories as shown can be purchased separately.

## WARRANTY

### LIGHT COMMERCIAL WARRANTY

**10 YEARS:** Structural main frames, welds, cams and weight plates.

**5 YEARS:** Pivot bearings, pulleys, bushings and guide rods.

**1 YEAR:** Cables, linear bearings and pull-pin components.

**6 MONTHS:** Upholstery, finish and rubber grips.

**ALL OTHER PARTS** not mentioned elsewhere in the warranty will expire one (1) year from the date of purchase to the original purchaser.

**Light Commercial Use:** Light Commercial warranty applies only to facilities like hotels, apartment complexes, personal training studios, fire & police stations, etc. where the equipment would be used by no more than 30 people per day.

### HOME LIFETIME WARRANTY

Lifetime on everything to the original purchaser, when used only in a HOME environment, applies to defects from manufacturer only.

**NOTICE:** TuffStuff continually engages in research related to product improvement. As a result, the product received by the customer may differ slightly from its published description. Improvements in materials, production techniques and design refinement may at any time be introduced into our products. TuffStuff reserves the right to make changes in its product without notice.



13971 Norton Avenue, Chino, CA 91710 PH: 909-629-1600 FX: 909-629-4967

[www.tuffstufffitness.com](http://www.tuffstufffitness.com)

01.25.2019\_050317