

SPIRIT

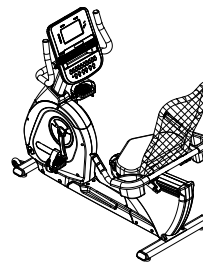

XBR95 SEMI - RECUMBENT BIKE
OWNER'S MANUAL

TABLE OF CONTENTS

3	IMPORTANT SAFETY INSTRUCTIONS
4	IMPORTANT ELECTRICAL INSTRUCTIONS
5	IMPORTANT OPERATION INSTRUCTIONS
5	PRODUCT REGISTRATION
6	XBR95 ASSEMBLY INSTRUCTIONS
13	CONSOLE OPERATION
19	PROGRAMMABLE FEATURES
32	USING HEART RATE TRANSMITTER
35	GENERAL MAINTENANCE
36	MANUFACTURER'S LIMITED WARRANTY

Thank you for purchasing our product, please save these instructions. Please do not perform or attempt any customizing, adjustments, repair or maintenance that is not described in this manual.

SPIRIT

Congratulations on your new semi-recumbent bike and welcome to the Spirit Fitness family!

Thank you for your purchase of this quality semi-recumbent bike from Spirit Fitness. Your new semi-recumbent bike was manufactured by one of the leading fitness manufacturers in the world and is backed by one of the most comprehensive warranties available. Through your dealer, Spirit Fitness will do all we can to make your ownership experience as pleasant as possible for many years to come. If not purchased direct from Spirit Fitness, the local dealership where you purchased this semi-recumbent bike is your administrator for all Spirit Fitness warranty and service needs. Their responsibility is to provide you with the technical knowledge and service personnel to make your experience more informed and any difficulties easier to remedy.

Please take a moment at this time to record the name of the dealer, their telephone number, and the date of purchase below to make any future, needed contact easy. We appreciate your support and we will always remember that you are the reason that we are in business.

Yours in Health,
Spirit Fitness

NAME OF DEALER _____

DEALER PHONE # _____

PURCHASE DATE _____

Important Safety Instructions

WARNING

When using an electrical appliance, basic precautions should always be followed, including the following:

Read all instructions before using this appliance.

DANGER - To reduce the risk of electric shock:

Always unplug this appliance from the electrical outlet immediately after using and before cleaning.

WARNING - To reduce the risk of burns, fire, electric shock, or injury to persons, install the bike on a flat level surface with access to a 115-volt, 15-amp grounded outlet with only the bike plugged into the circuit.

DO NOT USE AN EXTENSION CORD UNLESS IT IS A 18AWG OR BETTER, WITH ONLY ONE OUTLET ON THE END:

- To reduce the risk of burns, fire electric shock, or injury to persons:
- An appliance should never be left unattended when plugged in. Unplug from outlet when not in use, and before putting on or taking off parts.
- Do not operate under blanket or pillow. Excessive heating can occur and cause fire, electric shock, or injury to persons.
- Close supervision is necessary when this appliance is used by, on, or near children, invalids, or disabled persons.
- Use this appliance only for its intended use as described in this manual. Do not use attachments not recommended by the manufacturer.

- Never operate this appliance if it has a damaged cord or plug, if it is not working properly, if it has been dropped or damaged, or dropped into water. Return the appliance to a service center for examination and repair.
- Do not carry this appliance by supply cord or use cord as a handle.
- Keep the cord away from heated surfaces.
- Never operate the appliance with the air openings blocked. Keep the air openings free of lint, hair, and the like.
- Never drop or insert any object into any opening.
- Do not use outdoors.
- Do not operate where aerosol (spray) products are being used or where oxygen is being administered.
- Connect this appliance to a properly grounded outlet only.
- The appliance is intended for household use.
- This exercise equipment is not intended for use by persons with reduced physical, sensory or mental capabilities, or lack of experience and knowledge.
- Keep children under the age of 13 away from this machine.

WARNING: This product can expose you to chemicals including Toluene and Acrylamide which are known to the State of California to cause cancer and birth defects or other reproductive harm.

For more information go to www.P65Warnings.ca.gov

SAVE THESE INSTRUCTIONS - THINK SAFETY!

Fitness Equipment Safety Instructions

To disconnect turn all controls to the off position, then remove the plug from the outlet.

- Do not operate equipment on deeply padded, plush or shag carpet. Damage to both carpet and equipment may result.
- Before beginning this or any exercise program, consult a physician. This is especially important for persons over the age of 35 or persons with pre-existing health conditions.
- Do not attempt to use your equipment for any purpose other than for the purpose it is intended.
- Keep hands away from all moving parts.
- The pulse sensors are not medical devices. Their purpose is to provide you with an approximate measurement in relation to your target heart rate. Use of a chest transmitter strap (sold separately) is a much more accurate method of heart rate analysis. Various factors, including the user's movement, may affect the accuracy of heart rate readings. The pulse sensors are intended only as exercise aids in determining heart rate trends in general.
- Wear proper shoes. High heels, dress shoes, sandals or bare feet are not suitable for use on your equipment. Quality athletic shoes are recommended to avoid leg fatigue.

Failure to follow all guidelines may compromise the effectiveness of the exercise experience, expose yourself (and possibly others) to injury, and reduce the longevity of the equipment.

Important Electrical Instructions

WARNING

NEVER expose this Semi-Recumbent Bike to rain or moisture. This product is **NOT** designed for use outdoors, near a pool or spa, or in any other high humidity environment. The operating temperature specification is 40 to 120 degrees Fahrenheit, and humidity is 95% non-condensing (no water drops forming on surfaces).

Important Operation Instructions

- **NEVER** operate this Semi-Recumbent Bike without reading and completely understanding the results of any operational change you request from the computer.
- Understand that changes in resistance do not occur immediately. Set your desired resistance level on the computer console and release the adjustment key. The computer will obey the command gradually.
- Use caution while participating in other activities while pedaling on your Semi-Recumbent Bike; such as watching television, reading, etc. These distractions may cause you to lose balance which may result in serious injury.
- Do not use excessive pressure on console control keys. They are precision set to function properly with little finger pressure.

Record Your Serial Number

Please record the serial number of this fitness product in the space provided below.

Serial Number:

Register Your Purchase

The self-addressed product registration card must be completed in full and returned to Spirit Fitness. You can also go to <http://www.spiritfitness.com/residentialwarrantyregistration.html> under the Support tab to register online.

Serial Number Location

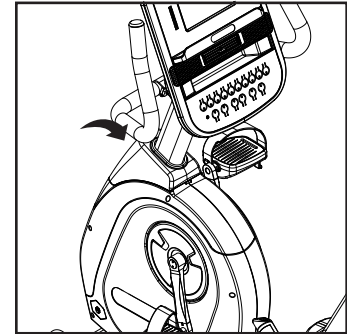

XBR95 PRE ASSEMBLY

UNPACKING

1. Cut the straps, then along the dotted line on the bottom of the box; lift the box over the unit and unpack.
2. Locate the hardware package. The hardware is separated into four steps. Remove the tools first. Remove the hardware for each step as needed to avoid confusion. The numbers in the instructions that are in parenthesis (#) are the item number from the assembly drawing for reference.

TOOLS INCLUDED:

- 12/14mm Wrench
- 14/15mm Wrench
- Phillips Screwdriver

PARTS INCLUDED:

- 1 Main Frame
- 1 Console Mast
- 1 Rear Stabilizer
- 1 Seat Back Frame
- 1 Front Handle Bar
- 1 Handle Bar
- 1 Seat Back Cover
- 1 Console Mast Cover
- 1 Front Stabilizer Cover
- 1 Rear Stabilizer Cover
- 1 Console
- 1 Seat Cushion
- 2 Cup Holders
- 2 Pedals
- 1 Hardware Kit

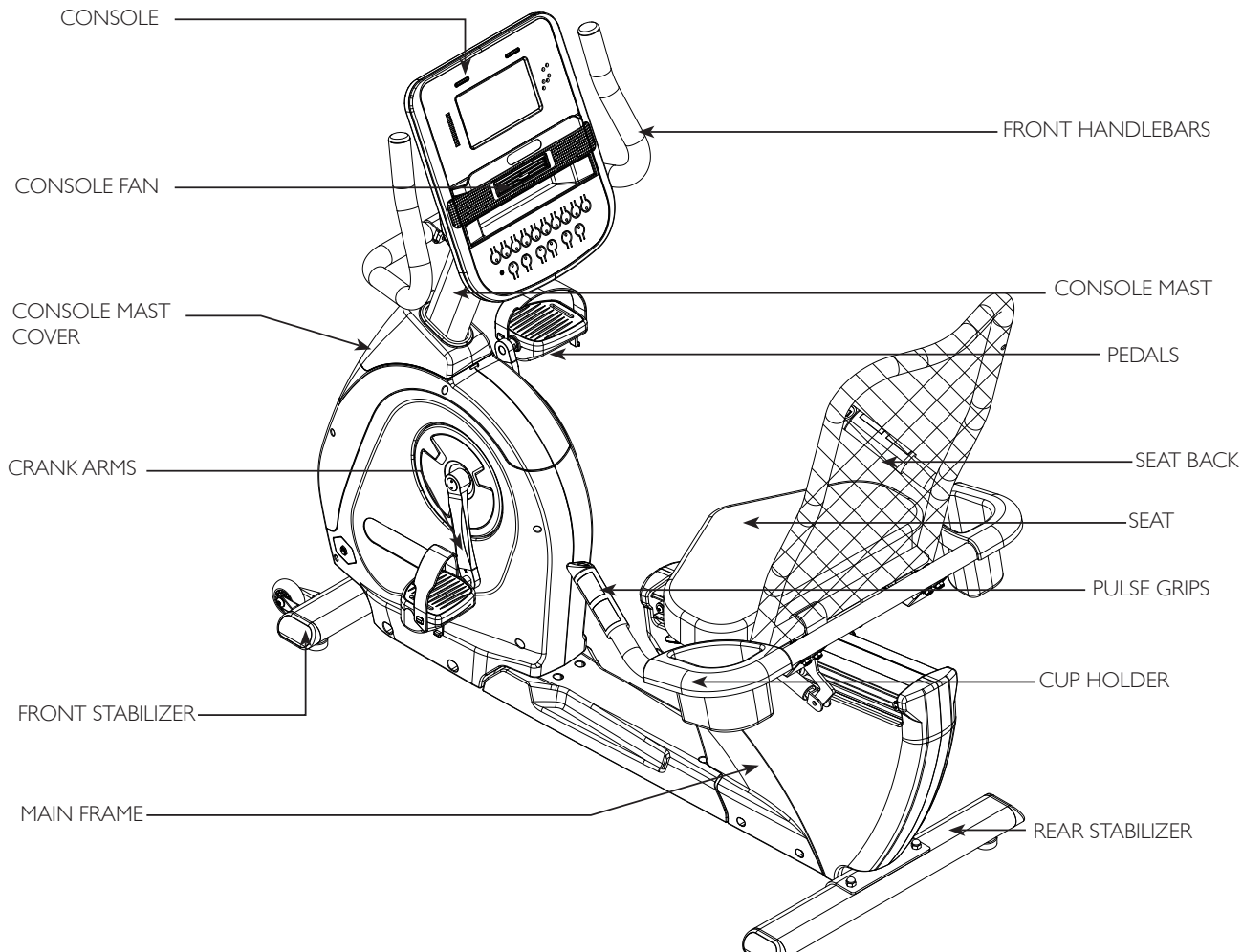

XBR95 STEP ONE

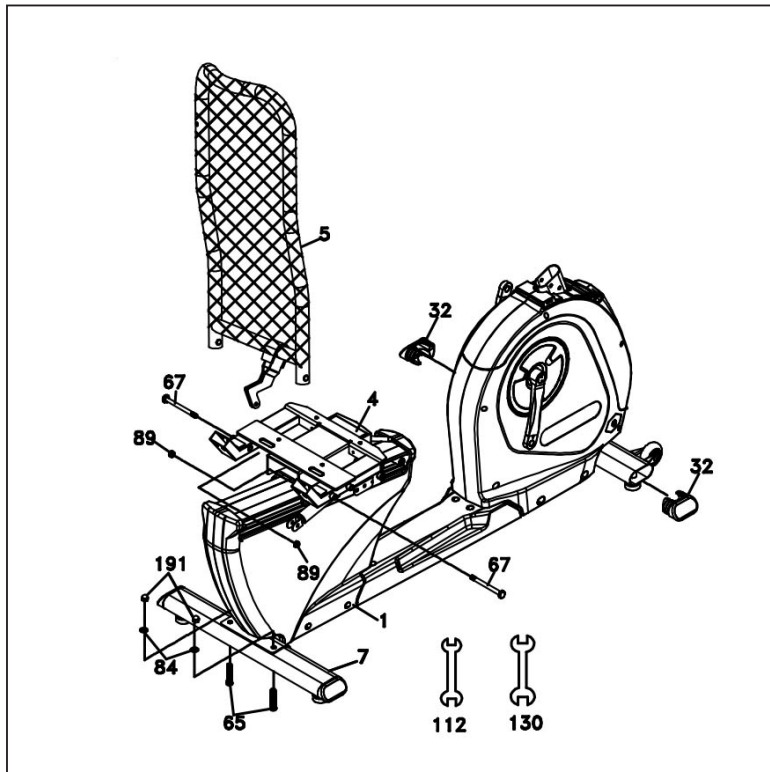

HARDWARE FOR STEP I			
PART	TYPE	DESCRIPTION	QTY
65	BOLT	3/8"X53mm	2
67	BOLT	3/8"XUNC16X4"	2
84	FLAT WASHER	Ø3/8" × Ø25 × 2T	2
89	NYLOC NUT	3/8"X7T	2
191	CAP NUT	3/8"XUNC16X12.5T	2

1. Gather **HARDWARE FOR STEP I**.
2. Attach the **REAR STABILIZER (7)** to the **MAIN FRAME (1)** with the 2 **BOLTS (65)** and 2 **FLAT WASHERS (84)** and 2 **CAP NUTS (191)**. Tighten completely with the **WRENCH (112)**.
3. Attach the **SEAT BACK (5)** to the **SEAT CARRIAGE (4)** of the main frame. Slide 1 **BOLT (67)** through each side, then attach a **NYLOC NUT (89)** to each bolt. Tighten the bolts just enough so there is no side to side play, but freedom of movement front to back. Use the **WRENCHES** provided (**112 & 130**).
4. Insert an **END CAP (32)** into each opening of the **Front Stabilizer Tube**. You may need to tap them in with a rubber mallet if they are tight.

XBR95 STEP TWO

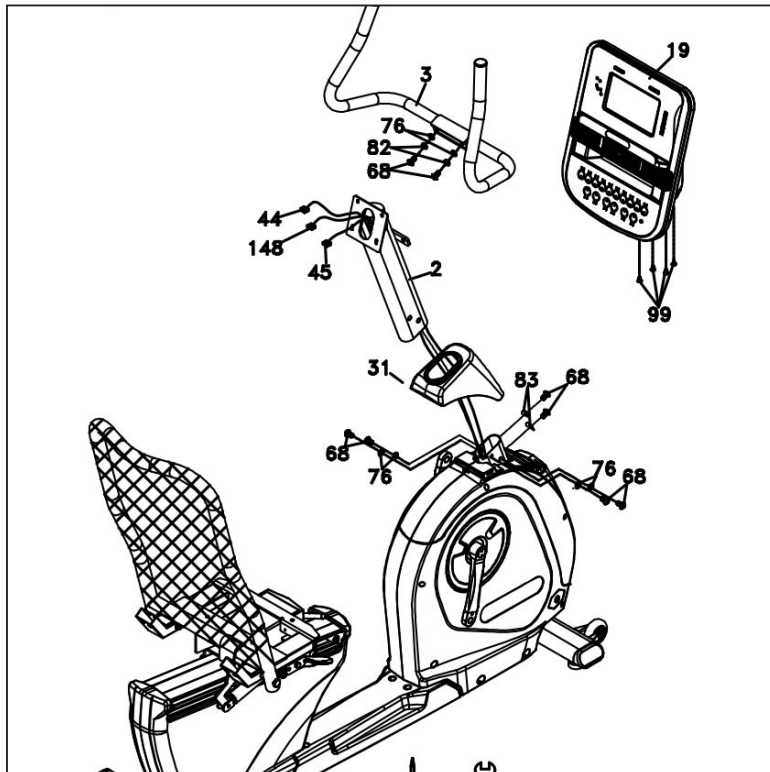

HARDWARE FOR STEP 2

PART	TYPE	DESCRIPTION	QTY
68	BOLT	5/16"XUNC18X5/8"	8
76	FLAT WASHER	Ø5/16" × Ø18 × 1.5T	6
82	SPLIT WASHER	5/16"X1.5T	2
83	CURVED WASHER	Ø5/16" × 19 × 1.5T	2
99	PHILLIPS HEAD SCREW	M5 × 12mm	4

1. Gather **HARDWARE FOR STEP 2**.
2. Slide the **COMPUTER CABLE (44)**, **HANDLEBAR RESISTANCE CONTROL CABLE (148)**, and **HAND PULSE CABLE (45)** through the bottom of the **CONSOLE MAST COVER (31)** and then the bottom of the **CONSOLE MAST (2)**. Make sure the Console Mast Cover is correctly oriented (see illustration).
3. Install the **CONSOLE MAST (2)** into the receiving tube (make sure not to pinch cables; damage to the electronics could occur) of the **MAIN FRAME (1)**. Insert 2 **BOLTS (68)** and 2 **FLAT WASHERS (76)** on each side. Insert 2 **BOLTS** and 2 **CURVED WASHERS (83)** on the front. Tighten all 6 bolts firmly with the **WRENCH (112)**.

Continued on next page...

4. Remove the white styrofoam pad (factory installed to prevent bolts from being accidentally dropped into the Console Mast Tube).
5. Attach the **HANDLE BAR ASSEMBLY (3)** onto the **CONSOLE MAST (2)** bracket with the 2 **BOLTS (68)**, 2 **SPLIT WASHERS (82)**, and 2 **FLAT WASHERS (76)**. Completely tighten with the **WRENCH (112)**. Insert the **COMPUTER CABLE (44)**, **HANDLEBAR RESISTANCE CONTROL CABLE (148)**, and **HAND PULSE CABLE (45)** into their respective connectors in the back of the **CONSOLE ASSEMBLY (19)**. Attach the console onto the mounting plate with 4 **PHILLIPS HEAD SCREWS (99)**. Tighten with the **PHILLIPS HEAD SCREW DRIVER (114)**.

XBR95 STEP THREE

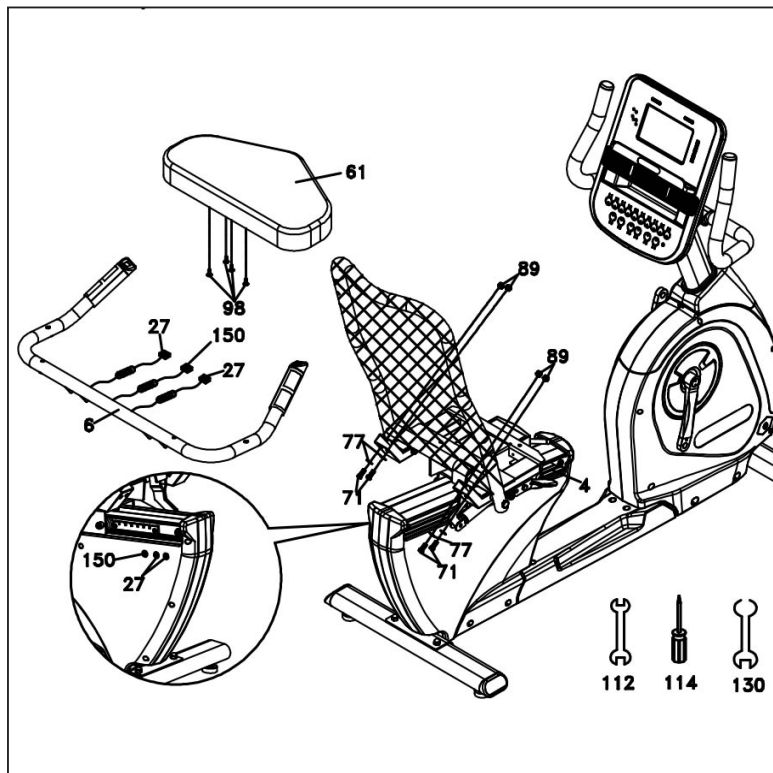

HARDWARE FOR STEP 3			
PART	TYPE	DESCRIPTION	QTY
71	BOLT	3/8" X 1-3/4"	4
77	FLAT WASHER	Ø3/8" X Ø19 X 1.5T	4
89	NYLOC NUT	3/8"X7T	4
98	PHILLIPS HEAD SCREW	M6X15MM	4

1. Gather **HARDWARE FOR STEP 3**.
2. Install the **SEAT (61)** on the **SEAT CARRIAGE (4)** with 4 **PHILLIPS HEAD SCREWS (98)**. Tighten with the **PHILLIPS HEAD SCREW DRIVER (114)**.
3. Attach the **SEAT HANDLE BAR (6)** to the **SEAT CARRIAGE (4)** with the 4 **Hex Head Bolts (71)**, 4 **FLAT WASHERS (77)**, and 4 **Nyloc Nuts (89)**. Tighten with the **WRENCHES** provided (**112 & 130**).
4. Plug the **HAND PULSE SENSOR CABLES (27)** into the rear two holes on the left side of the rear plastic cover. Plug the **HANDLEBAR RESISTANCE CABLES (150)** into the remaining front hole.

XBR95 STEP FOUR

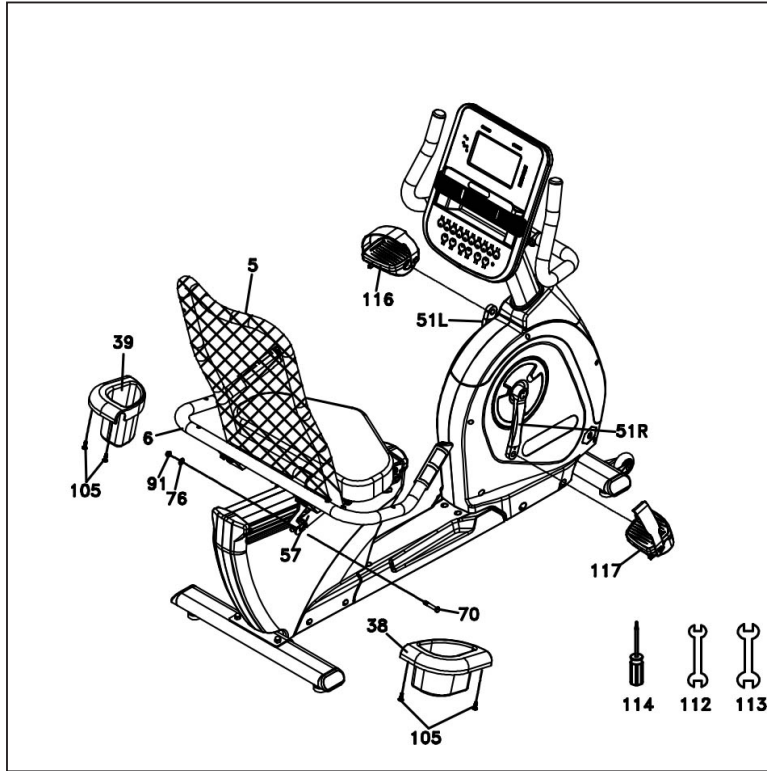

HARDWARE FOR STEP 4			
PART	TYPE	DESCRIPTION	QTY
70	BOLT	5/16"XUNC18X1-1/4"	1
76	FLAT WASHER	Ø5/16" × Ø18 × 1.5T	1
91	NYLOC NUT	5/16"X6T	1
105	SHEET METAL SCREW	4X16MM	4

1. Gather **HARDWARE FOR STEP 4**.
2. Install the **GAS CYLINDER (57)** on the **SEAT BACK FRAME (5)** with 1 **BOLT (70)**, 1 **FLAT WASHER (76)** and 1 **NYLOC NUT (91)** by using the **WRENCHES** provided (**112 & 113**).
3. Attach the **PEDALS (116L, 117R)** to the **CRANK ARMS (51L, 51R)**. Tighten with the **WRENCH (113)**. Remember that the **LEFT PEDAL** has a reverse thread and will be threaded onto the Crank arm in a **COUNTERCLOCKWISE** motion. There is an "L" stamped in the end of the threaded post of the left pedal and an "R" in the right. Make sure to tighten the pedals as firmly as you can. It may be necessary to re-tighten the pedals if you feel a thumping while pedaling the bike. A thumping or clicking noise is usually caused by loose pedals.
4. Attach the **DRINK BOTTLE HOLDERS (39L & 38R)** to the sides of the **SEAT HANDLE BAR (6)** with 4 **SHEET METAL SCREWS (105)**. Tighten with the **PHILLIPS HEAD SCREW DRIVER (114)**.

XBR95 CONSOLE OPERATION

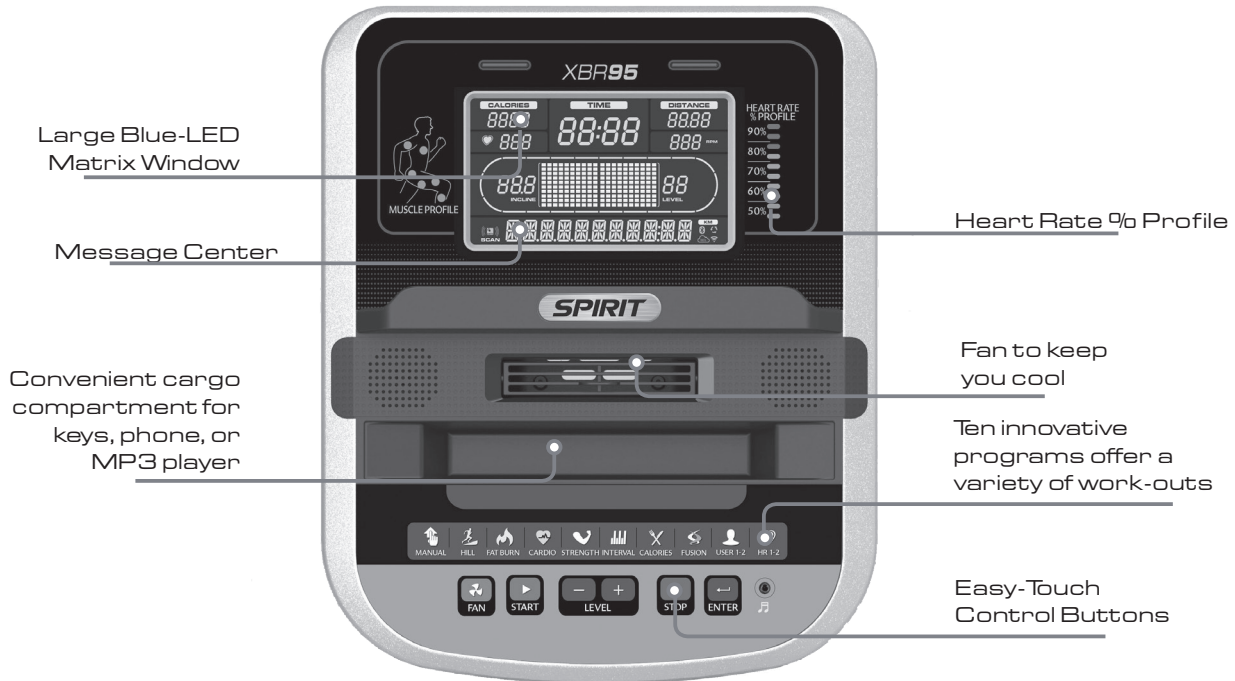

POWER

Spirit Fitness commercial Semi - Recumbent Bikes have a built-in generator for power and do not need to be plugged into an AC outlet. To power up the Semi - Recumbent Bike simply start to pedal, the console will turn on automatically.

When initially powered on the console will perform an internal self-test. During this time all the lights will turn on for a short time. When the lights go off the dot matrix display will show a software version (i.e. VER 1.0) and the **Message center** will display an odometer reading. The odometer reading displays how many hours the Semi - Recumbent Bike has been used and how many virtual miles the Semi - Recumbent Bike has gone. The display shows: ODO 123 MI 123 HRS.

The odometer will remain displayed for only a few seconds then the console will go to the start up display. The dot matrix display will be scrolling through the different profiles, showing the programs, and the **Message center** will be scrolling the start up message. You may now begin your workout program.

Dot Matrix Center Display

Twenty columns of boxes (10 high) indicate each segment of a workout. The boxes only show an approximate level (resistance) of effort. They do not necessarily indicate a specific value - only an approximate percent to compare levels of intensity. In Manual Operation the resistance dot matrix window will build a profile "picture" as values are changed during a workout.

1 / 4 Mile Track

The 1/4-mile track (one lap) will be displayed around the dot matrix window. The flashing segment

indicates your progress. Once the 1/4-mile (Metric - 0.4k) is complete this feature will begin again. The Lap track will move in a counterclockwise direction. There is a lap counter in the message center for monitoring your distance.

Pulse Grip Feature

The Pulse (Heart Rate) window will display your current heart rate in beats per minute during the workout. You must use both stainless steel sensors on the stationary grips or the heart rate transmitter chest strap to display your pulse. Pulse value displays anytime the upper display is receiving a Pulse signal. You may not use the Pulse Grip feature while in Heart Rate Programs.

Calorie Display

Displays the cumulative calories burned at any given time during your workout.

Note: This is only a rough guide used for comparison of different exercise sessions, and is not to be used for medical purposes.

Speakers

The console has built-in Speakers and an audio input jack. There is no volume control on the console. The volume must be controlled on the Audio Source.

Muscle Activation Figure

There is an anatomical figure located at the top of the console. This figure will light all areas that are activated when using the bike. These will light up during any of the programs. You can control which muscles are activated by customizing the resistance profile during the set up phase of console programming. If you accept the default program profile, the selected program will determine which

muscles will be activated by automatically adjusting the resistance. Generally the following guidelines hold true:

- The upper body LED's will not light
- The lower body lights will activate in three degrees of engagement: Green represents minimal muscle involvement, yellow represents medium involvement, and red represents full or heavy activation.
- These are the different scenarios for lower body muscle activation:
 - Levels 1-20: Green – Hamstrings & Gluteals light up; Amber – Quadriceps & Calves light up
 - Levels 21-40: Amber – Hamstrings & Gluteals light up; Red – Quadriceps & Calves light up

Heart Rate % Profile

The console LCD screen will display your current heart rate anytime a pulse is detected. The Bar Graph, located to the right of the LCD screen, will show your current heart rate % in relation to your projected maximum heart rate, which is determined by your age that you entered during the programming phase of any of the 10 programs. The significance of the bar graph colors are as follows:

- 50-60% of maximum is Amber
- 65-80% of maximum is Amber and Green
- 85-90% or more is Amber, Green, and Red

Quick Start

This is the quickest way to start a workout. After the console powers up you just press the **Start** key to begin, this will initiate the Quick Start mode. In Quick Start the Time will count up from zero and the workload may be adjusted manually by pressing the **Level Up/ Down** buttons. The dot matrix

display will have only the bottom row lit at first. As you increase the work load more rows will light indicating a harder workout. The fitness bike will get harder to pedal as the rows increase.

There are 40 levels of resistance available for plenty of variety. The first 10 levels are very easy workloads and the changes between levels are set to a good progression for de-conditioned users. Levels 11-20 are more challenging, but the increases in resistance from one level to the next remain small. Levels 21-30 start getting tough as the levels jump more dramatically. Levels 31-40 are extremely hard and are good for short interval peaks and elite athletic training.

Basic Information

The Message Center will initially be displaying the Program name. When in scan mode during a program, speed will be displayed for four seconds, then move on and display Watts (indication of workload). If 100 watts is displayed, you are doing enough work to keep a 100-watt light bulb lit. The data changes to Laps completed, Segment time, Max level. Pressing the **Enter** button again will bring you back to the beginning.

The **Stop** button actually has several functions. Pressing the **Stop** key once during a program will pause the program for 5 minutes. If you need to get a drink, answer the phone or any of the many things that could interrupt your workout, this is a great feature. To resume your workout during Pause, just press the **Start** key. If the **Stop** button is pressed twice during a workout, the program will end and the console will display your Workout Summary (Total time, Avg. Speed, Avg. Watts, Avg. HR, total Laps). If the **Stop** key is held down for 3 seconds or a third time during the program, the console will perform a complete **Reset**. During data entry for a program the **Stop** key performs a previous screen

or segment function. This allows you to go back to change programming data.

Program Keys

The program keys are used to preview each program. When you first turn the console on you may press each program key to preview what the program profile looks like. If you decide that you want to try a program, press the corresponding program key and then press the **Enter** key to select the program and enter into the data-setting mode.

The fitness bike has a built-in heart rate monitoring system. Simply grasping the hand pulse sensors on the stationary handle bars or wearing the heart rate transmitter (see Using Heart Rate Transmitter section) will start the Heart Icon blinking (this may take a few seconds). The Pulse Display Window will display your heart rate, or Pulse in beats per minute.

The console includes a built-in fan to help keep you cool. To turn the fan on, press the button on the left side of the console.

Programming The Console

Each of the programs can be customized with your personal information and changed to suit your needs. Some of the information asked for is necessary to ensure the readouts are correct. You will be asked for your **Age** and **Weight**. Entering your **Age** ensures that the Heart Rate bar graph shows the correct number. Your **Age** is also necessary during the Heart Rate control program to ensure the correct settings are in the program for your **Age**. Otherwise the work settings could be too high or low for you; entering your **Weight** aides in calculating a more correct Calorie reading. Although we

cannot provide an exact calorie count we do want to be as close as possible.

CALORIE NOTE: Calorie readings on every piece of exercise equipment, whether it is in a gym or at home, are not accurate and tend to vary widely. They are meant only as a guide to monitor your progress from workout to workout. The only way to measure your calorie burn accurately is in a clinical setting connected to a host of machines. This is because every person is different and burns calories at a different rate. Some good news is that you will continue to burn calories at an accelerated rate for at least an hour after you have finished exercising!

Entering A Program & Changing Settings

When you enter a program, by pressing a program key, then **Enter** key, you have the option of entering your own personal settings. If you want to workout without entering new settings, then just press the **Start** key. This will bypass the programming of data and take you directly to the start of your workout. If you want to change the personal settings then just follow the instructions in the Message Center. If you start a program without changing the settings, the default or saved settings will be used.

NOTE: Age and Weight default settings will change when you enter a new number. So the last Age and Weight entered will be saved as the new default settings. If you enter your Age and Weight the first time you use the fitness bike, you will not have to enter it every time you work out unless either your Age or Weight changes, or someone else enters a different Age and Weight.

Programmable Features MANUAL

The Manual program works as the name implies, manually. This means that you control the workload yourself and not the computer. To start the Manual program follow the instructions below or just press the **Manual** button then the **Enter** button and follow the directions in the Message center.

1. Press the **Manual** key, then press the **Enter** key.
2. The **Message Center** will ask you to enter your Age. You may enter your age, using the **LEVEL Up/Down keys**, then press the **Enter** key to accept the new value and proceed on to the next screen.
3. You are now asked to enter your Weight. You may adjust the Weight value using the **LEVEL Up/Down keys**, then press **Enter** to continue.
4. Next is Time. You may adjust the Time and press **Enter** to continue.
5. Now you are finished editing the settings and can begin your workout by pressing the **Start** key. You can also go back and modify your settings by pressing the **Stop** key.
NOTE: At any time during the editing of Data you can press the Stop key to go back one level, or screen.
6. Once the program starts you will be at level one. This is the easiest level and it is a good idea to stay at level one for a while to warm up. If you want to increase the work load at any time press the **LEVEL Up key**; the **LEVEL Down key** will decrease the work-load.
7. During the Manual program you will be able to scroll through the data in the **Message Center** by pressing the **Enter** key.
8. When the program ends you may press **Start** to begin the same program again or **Stop** to exit the program or you can save the program you just completed as a custom user program by pressing a **User** key and following the instructions in the Message Center.

Calories Program

1. Press the **Calories** key. Press **Enter** to select the program. The display will prompt you through the programming.
2. If Enter was pressed, the Message Center will now be blinking a value, indicating your Age (default is 35). Entering your correct age affects the heart rate Bar Graph Display and the Heart Rate programs. Use the **Level Up/Down keys** to adjust, then press **Enter**. Your age determines your recommended maximum heart rate. Since the Bar Graph Display and the Heart Rate program features are based on a percentage of your maximum heart rate, it is important to enter the correct age for these features to work properly.

3. The Message Center will now be blinking a value, indicating your Body Weight. Entering the correct body weight will affect the calorie count. Use the **Level Up/Down keys** to adjust, then press **Enter**.

A note about the Calorie display: No exercise machine can give you an exact calorie count because there are too many factors which determine exact calorie burn for a particular person. Even if someone is the exact same body weight, age and height, their calorie burn may be very different than yours. The Calorie display is to be used as a reference only to monitor improvement from workout to workout.

4. The Message Center displays "Use Level Up or Down keys to adjust Calorie burn" (default is 300) After adjusting, press **Enter**.
5. The Message Center will now be blinking the preset Avg. pedal RPM (revolutions per minute) (default is 50); After adjusting press **Enter**.
6. The Message Center will now be blinking the preset top resistance of the selected program (default is Level 5). Use the **Level Up/Down keys** to adjust, then press **Enter**. Each program has various resistance changes throughout; this allows you to limit the highest resistance the program can reach.
7. The Message Center displays the Program Time (a value that was determined by the data you entered in steps 3-6); Press **Start** to accept the calculated Time or the **Enter** key to return to steps 4-6 and change the data, which will recalculate the Program Time.
 - When the **Start** key is pressed, the program begins with a 3:00 warm up (1:00 @ Level 1, 1:00 @ Level 2, and 1:00 @ Level 3) or you have the option of pressing the **Enter** key again to bypass and begin the workout.
 - When the program begins both the Calorie and Time windows will count down to 0. If the Time expires before calories burned reaches 0, the Time window will begin accumulated time, until Calories reach 0.
 - After the program has ended, there will be a 3:00 cool down (1:00 @ Level 3, 1:00 @ Level 2, and 1:00 @ Level 1) or you have the option of pressing the **Enter** key to end the workout.

Fusion Program

In this interval program you will alternate between mid-high intensity cardiovascular intervals on the bike, strength exercises off of the bike, and low intensity recovery intervals on the bike. You will need a pair of objects that can be comfortably held in your hands (dumbbells, water jugs, soup cans, etc.) for 4 of the 5 strength exercises performed in this program

1. Press the **Fusion** key. Press **Enter** to select the program. The display will prompt you through the programming.
2. If **Enter** was pressed, the Message center will now be blinking a value, indicating your Age (default is 35). Entering your correct age affects the heart rate Bar Graph Display and the Heart Rate programs. Use the **Level Up/Down keys** to adjust, then press **Enter**. Your age determines your recommended maximum heart rate. Since the Bar Graph Display and the Heart Rate features are based on a percentage of your maximum heart rate, it is important to enter the correct age for these features to work properly.
3. The Message Center will now be blinking a value, indicating your Body Weight. Entering the correct body weight will affect the calorie count. Use the **Level Up/Down keys** to adjust, then press **Enter**. *A note about the Calorie display: No exercise machine can give you an exact calorie count because there are too many factors which determine exact calorie burn for a particular person. Even if someone is the exact same body weight, age and height, their calorie burn may be very different than yours. The Calorie display is to be used as a reference only to monitor improvement from workout to workout. The calorie count displayed in this program won't be accurate because the machine can't calculate calories expended while strength training.*
4. The Message Center will now be blinking the preset top Resistance level of the selected program (default/mini- mum resistance is Level 5). Use the **Level Up/Down keys** to adjust, then press **Enter**. This value will be the Level for all cardio intervals. The resistance level can be adjusted at any time during the program.
5. The Message Center will be blinking the number of intervals desired (default is 10); you may select 10 (5 cardio & 5 strength), 20 (10 cardio & 10 strength), or 30 (15 cardio & 15 strength). Use the **Level Up/Down keys** to adjust, then press **Enter**.
6. The Message Center will be blinking the desired Interval time (default is 2:00). The time you select will be the duration of each cardio interval. *Note: As a general rule, the longer the interval, the less resistance (fitness bike) is required and the*

*more repetitions you perform, the less weight (dumbbells) you need to use; use the **Level Up/Down keys** to adjust, then press **Enter**.*

7. The Message Center will be blinking the recovery time you desire (default is 0:30) after completing both the cardio & strength intervals. Use the **Level Up/Down keys** to adjust, then press **Enter**.

CAUTION: The shorter the recovery time, the longer your heart rate will stay elevated; if you are new to exercise or have recently resumed an exercise program after a considerable amount of time off, it is recommended that your recovery interval length either matches or exceeds the length of the cardio interval.

Preset Programs

The Semi - Recumbent Bike has seven different programs that have been designed for a variety of workouts. These seven programs have factory preset work level profiles for achieving different goals.

HILL

This program follows a triangle or pyramid type of gradual progression from approximately 10% of maximum effort (the level that you chose before starting this program) up to a maximum effort which lasts for 10% of the total workout time, then a gradual regression of resistance back to approximately 10% of maximum effort

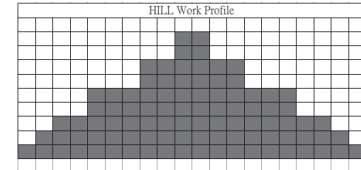

FAT BURN

This program follows a quick progression up to the maximum resistance level (default or user input level) that is sustained for 2/3 of the workout. This program will challenge your ability to sustain your energy output for an extended period of time.

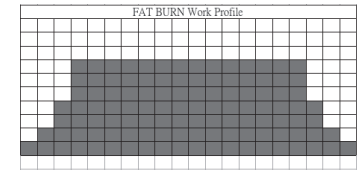

CARDIO

This program presents a quick progression up to near maximum resistance level (default or user input level). It has slight fluctuations up and down to allow your heart rate to elevate, and then recover repeatedly, before beginning a quick cool down. This will build up your heart muscle and increase blood flow and lung capacity

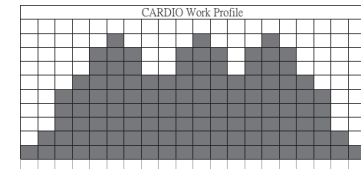

STRENGTH

Resistance: This program has a gradual progression of resistance up to 100% of maximum effort that is sustained for 25% of workout duration. This will help build strength and muscular endurance in the lower body and glutes. A brief cool down follows.

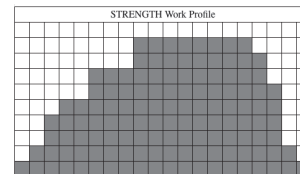

INTERVAL

This program takes you through high levels of intensity followed by recovery periods of low intensity. This program utilizes and develops your "Fast Twitch" muscle fibers which are used when performing tasks that are intense and short in duration. These deplete your oxygen level and spike your heart rate, followed by periods of recovery and heart rate drop to replenish oxygen. Your cardiovascular system gets programmed to use oxygen more efficiently.

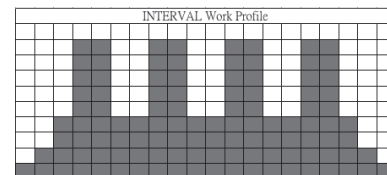

CALORIES

This program follows a quick progression up to the maximum resistance level (default or user input level) that is sustained for 2/3 of the workout. This program will challenge your ability to sustain your energy output for an extended period of time.

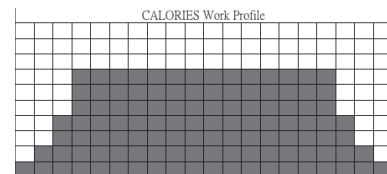

FUSION

This program takes you through high levels of cardio & strength intensity followed by recovery periods of low intensity. This program utilizes and develops your "Fast Twitch" muscle fibers which are used when performing tasks that are intense and short in duration. These deplete your oxygen level and spike your heart rate, followed by periods of recovery and heart rate drop to replenish oxygen. Your cardiovascular system gets programmed to use oxygen more efficiently.

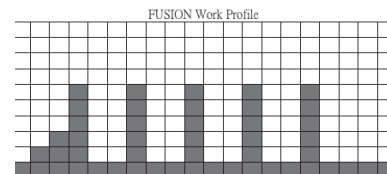

Programming Preset Programs

1. Select the desired program button then press the **Enter** key.
2. The Message Center will ask you to enter your Age. You may adjust the age setting, using the **Level Up/Down keys**, then press the **Enter** key to accept the new number and proceed on to the next screen.
3. You are now asked to enter your Weight. You may adjust the Weight value using the **Level Up/Down keys**, then press **Enter** to continue.
4. Next is Time. You may adjust the time and press **Enter** to continue.
5. Now you are asked to adjust the Max Resistance Level. This is the peak exertion level you will experience during the program. Adjust the level and then press **Enter**.
6. Now you are finished editing the settings and can begin your workout by pressing the **Start** key. You can also go back and modify your settings by pressing the **Enter** key.
7. If you want to increase or decrease the resistance at any time during the program, press the **Level Up/Down keys** on the console or above the heart rate sensor grips of the stationary handlebars. This will change the resistance settings of the entire profile, although the profile picture on the screen will not change. The reason for this is so that you can see the entire profile at all times. If the profile picture is changed, it also would be distorted and not a true representation of the actual profile. When you make a change to the resistance, the Message Center will show the current column and program maximum levels of work.
8. During the program you will be able to scroll through the data in the message window by pressing the **Enter** key.
9. When the program ends the Message Center will show a summary of your workout. The summary will be displayed for a short time, then the console will return to the start-up display.

Custom User Defined Programs

There are two customizable User programs that allow you to build and save your own workout. The two programs, User 1 and User 2, operate exactly the same way so there is no reason to describe them separately. You can build your own custom program by following the instructions below or you can save any other preset program you complete as a custom program. Both programs allow you to further personalize it by adding your name.

1. Select the **User** program (**U1** or **U2**) then press **Enter**. If you have already saved a program to either U1 or U2, it will be displayed and you are ready to begin. If not, you will have the option of inputting a username. In the Message Window, the letter "A" will be blinking. Use the **Level Up/Down buttons** to select the appropriate first letter of your name (pressing the **LEVEL Up/Down button** will switch to the letter "B"; pressing the Down button will switch to letter "Z"). Press **Enter** when the desired letter is displayed. Repeat this process until all of the characters of your name have been programmed (maximum 7 characters). When finished press **Stop**.
2. If there is a program already stored in User when you press the key, you will have an option to run the program as it is or delete the program and build a new one. At the welcome message screen, when pressing **Start** or **Enter** you will be prompted: Run Program? Use the **Level Up/Down** to select Yes or No. If you select No, you will then be asked if you want to delete the currently saved program. It is necessary to delete the current program if you want to build a new one. The Message Center will ask you to enter your Age. You may enter your age, using the **Level Up/Down keys**, then press the **Enter** key to accept the new value and proceed on to the next screen.
3. If there is a program already stored in User when you press the key, you will have an option to run the program as it is or delete the program and build a new one. At the welcome message screen, when pressing **Start** or **Enter** you will be prompted: Run Program? Use the **Level Up/Down** to select Yes or No. If you select No, you will then be asked if you want to delete the currently saved program. It is necessary to delete the current program if you want to build a new one.
4. The Message Center will ask you to enter your Age. You may enter your age, using the **Level Up/Down keys**, then press the **Enter** key to accept the new value and proceed on to the next screen.
5. You are now asked to enter your Weight. You may adjust the weight value using the **Up/ Down keys** then press Enter to continue.

6. Next is Time. You may adjust the time and press **Enter** to continue.
7. Now you are asked to adjust the Max Resistance Level of the program, press **Enter** when resistance has been selected.
8. Now the first column will be blinking and you are asked to adjust the resistance level for the first segment (SEGMENT > 1) of the workout by using the **Level Up key**. When you finish adjusting the first segment, or if you don't want to change, then press **Enter** to continue to the next segment.
9. The next segment will show the same workload resistance level as the previously adjusted segment. Repeat the same process as the last segment then press **Enter**. Continue this process until all twenty segments have been set.
10. The Message Center will then tell you to press **Enter** to save the program. After saving the program the Message Center says "PROG SAVED" then will give you the option to start or modify the program. Pressing **Stop** will exit to the start up screen.

Heart Rate Programs

The old motto, “no pain, no gain”, is a myth that has been overpowered by the benefits of exercising comfortably. A great deal of this success has been promoted by the use of heart rate monitors. With the proper use of a heart rate monitor, many people find that their usual choice of exercise intensity was either too high or too low and exercise is much more enjoyable by maintaining their heart rate in the desired benefit range.

To determine the benefit range in which you wish to train, you must first determine your Maximum Heart Rate. This can be accomplished by using the following formula: 220 minus your age. This will give you the Maximum Heart Rate (MHR) for someone of your age. To determine the effective heart rate range for specific goals you simply calculate a percentage of your MHR. Your Heart rate training zone is 50% to 90% of your maximum heart rate. 60% of your MHR is the recommended for burning fat while 80% is recommended for strengthening the cardio vascular system. This 60% to 80% is the zone to stay in for maximum benefit.

For someone who is 40 years old their target heart rate zone is calculated:
220 – 40 = 180 (maximum heart rate)
 $180 \times .6 = 108$ beats per minute (60% of maximum)
 $180 \times .8 = 144$ beats per minute (80% of maximum)
So for a 40 year old the training zone would be 108 to 144 beats per minute.

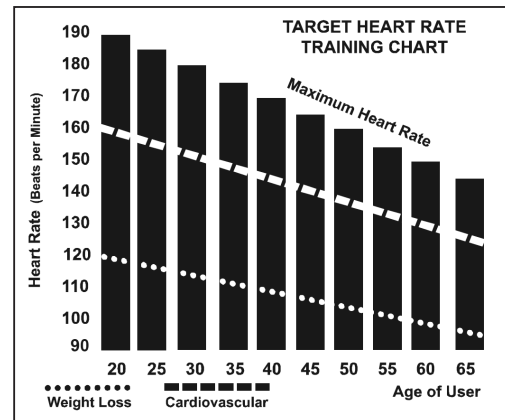

If you enter your age during programming the console will perform this calculation automatically. Entering your age is used for the Heart Rate programs. After calculating your MHR you can decide upon which goal you would like to pursue.

The two most popular reasons for, or goals, of exercise are cardiovascular fitness (training for the heart and lungs) and weight control. The black columns on the chart above represent the MHR for a person whose age is listed at the bottom of each column. The training heart rate, for either cardiovascular fitness or weight loss, is represented by two different lines that cut diagonally through the chart. A definition of the lines' goal is in the bottom left-hand corner of the chart. If your goal is cardiovascular fitness or if it is weight loss, it can be achieved by training at 80% or 60%, respectively, of your MHR on a schedule approved by your physician. Consult your physician before participating in any exercise program.

With all Spirit Fitness Heart Rate programs you may use the heart rate monitor feature without using the Heart Rate program. This function can be used during manual mode or during any of the nine different programs. The Heart Rate program automatically controls resistance at the pedals.

Rate of Perceived Exertion

Heart rate is important but listening to your body also has a lot of advantages. There are more variables involved in how hard you should workout than just heart rate. Your stress level, physical health, emotional health, temperature, humidity, the time of day, the last time you ate and what you ate, all contribute to the intensity at which you should workout. If you listen to your body, it will tell you all of these things.

The rate of perceived exertion (RPE), also known as the Borg scale, was developed by Swedish physiologist G.A.V. Borg. This scale rates exercise intensity from 6 to 20 depending upon how you feel or the perception of your effort.

The scale is as follows:

Rating Perception of Effort

6 Minimal	10 Very light +	14 Somewhat hard +	18 Very hard +
7 Very, very light	11 Fairly light	15 Hard	19 Very, very hard
8 Very, very light +	12 Comfortable	16 Hard +	20 Maximal
9 Very light	13 Somewhat hard	17 Very hard	

You can get an approximate heart rate level for each rating by simply adding a zero to each rating. For example a rating of 12 will result in an approximate heart rate of 120 beats per minute. Your RPE will vary depending upon the factors discussed earlier. That is the major benefit of this type of training. If your body is strong and rested, you will feel strong and your pace will feel easier. When your body is in this condition, you are able to train harder and the RPE will support this. If you are feeling tired and sluggish, it is because your body needs a break. In this condition, your pace will feel harder. Again, this will show up in your RPE and you will train at the proper level for that day.

Wearing The Chest Strap

1. Attach the transmitter to the elastic strap using the interlocking key.
2. Adjust the strap as tightly as possible as long as the strap is not too tight to remain comfortable.
3. Position the transmitter with the logo centered in the middle of your torso facing away from your chest (some people must position the transmitter slightly left of center). Attach the final end of the elastic strap by inserting the round end and, using the locking parts, secure the transmitter and strap around your chest.
4. Position the transmitter directly below the pectoral muscles.
5. Sweat is the best conductor to measure very minute heart beat electrical signals. However; plain water can also be used to pre-wet the electrodes (2 ribbed oval areas on the reverse side of the belt and both sides of the transmitter). It's also recommended that you wear the transmitter strap a few minutes before your work out. Some users, because of body chemistry, have a more difficult time in achieving a strong, steady signal at the beginning. After "warming up", this problem lessens.
6. Your workout must be within range - distance between transmitter/receiver – to achieve a strong steady signal. The length of range may vary somewhat but generally stay close enough to the console to maintain good, strong, reliable readings. Wearing the transmitter directly on bare skin assures you of proper operation. If you wish, you may wear the transmitter over a shirt. To do so, wet the areas of the shirt that the electrodes will rest upon.

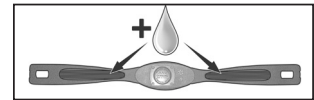
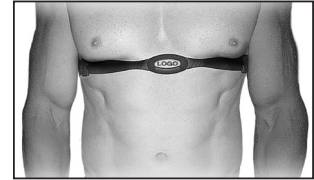

Note: *The transmitter is automatically activated when it detects activity from the user's heart. Additionally, it automatically deactivates when it does not receive any activity. Although the transmitter is water resistant, moisture can have the effect of creating false signals, so you should take precautions to completely dry the transmitter after use to prolong battery life (estimated transmitter battery life is 2500 hours). The replacement battery is Panasonic CR2032.*

Erratic Operation

Caution! Do not use this Semi - Recumbent Bike for Heart Rate programs unless a steady, solid Actual Heart Rate value is being displayed. High, wild, random numbers being displayed indicate a problem.

Areas to look for interference which may cause erratic heart rate:

1. Microwave ovens, TV's, small appliances, etc.
2. Fluorescent lights.
3. Some household security systems.
4. Perimeter fence for a pet.
5. Some people have problems with the transmitter picking up a signal from their skin. If you have problems try wearing the transmitter upside down. Normally the transmitter will be oriented so the Spirit Fitness logo is right side up.
6. The antenna that picks up your heart rate is very sensitive. If there is an outside noise source, turning the whole machine 90 degrees may de-tune the interference.
7. Another Individual wearing a transmitter within 3' of your machine's console.

If you continue to experience problems contact your dealer.

Heart Rate Program Operation

Note: You must wear the heart rate transmitter strap for these programs

Both programs operate the same, the only difference is that **HRI** is set to 60% and **HR2** is set to 80% of the maximum heart rate. They both are programmed the same way.

To start an HR program follow the instructions below or just select the **HRI** or **HR2** program, then the **Enter** button and follow the directions in the Message Center.

After selecting your heart rate target the program will attempt to keep you at or within 3-5 heart beats per minute of this value. Follow the prompts in the Message Center to maintain your selected heart rate value.

1. Press the **HR 1** or **HR 2** key then press the Enter key.
2. The Message Center will ask you to enter your Age.You may enter your age, using the **Level Up/Down keys**, then press the **Enter** key to accept the new value and proceed on to the next screen.
3. You are now asked to enter your Weight.You may adjust the weight value using the **Level Up/Down keys**, then press **Enter** to continue.
4. Next is Time.You may adjust the time and press **Enter** to continue.
5. Now you are asked to adjust the Heart Rate Target.This is the heart rate level you will strive to maintain during the program.Adjust the level using the **Level Up/Down keys**, then press **Enter**.
Note:The heart rate that appears is based on the % you accepted in Step 1. If you change this number it will either increase or decrease the % from Step 1.
6. Now you are finished editing the settings and can begin your workout by pressing the **Start** key.You can also go back and modify your settings by pressing the **Enter** key. Note:At any time during the editing of Data you can press the **Enter** key to go back one screen.
7. If you want to increase or decrease the workload at any time during the program press the **Level Up/Down key**.This will allow you to change your target heart rate at any time during the program.
8. During the **HR 1** or **HR 2** programs you will be able to scroll through the data in the Message Center by pressing the **Enter** key.
9. When the program ends you may press **Start** to begin the same program again or **Stop** to exit.

GENERAL MAINTENANCE

1. Wipe down all areas in the sweat path with a damp cloth after each workout.
2. If a squeak, thump, clicking or rough feeling develops the main cause is most likely one of two reasons:
 - I. The hardware was not sufficiently tightened during assembly. All bolts that were installed during assembly need to be tightened as much as possible. It may be necessary to use a larger wrench than the one provided if you cannot tighten the bolts sufficiently. I cannot stress this point enough; 90% of calls to the service department for noise issues can be traced to loose hardware.
 - II. The crank arm nut needs to be retightened
 - III. If squeaks or other noises persist, check that the unit is properly leveled. There are 2 leveling pads on the bottom of the rear stabilizer; use a 14mm wrench (or adjustable wrench) to adjust the levelers.

Engineering Mode Menu

The console has built in maintenance/diagnostic software. The software will allow you to change the console settings from English to Metric and turn off the beeping of the speaker when a key is pressed for example. To enter the Engineering Mode Menu, press and hold down the **Start**, **Stop** and **Enter** keys. Keep holding the keys down for about 5 seconds and the Message Center will display Engineering Mode Menu. Press the **Enter** key to access the menu below:

1. Key Test (Will allow you to test all the keys to make sure they are functioning)
2. LCD Test (Tests all the display functions)
3. Functions (Press Enter to access settings and Up arrow to scroll)
 - I. Display Mode (Turn off to have the console power down automatically after 20 minutes of inactivity)
 - II. Pause Mode (Turn on allow 5 minutes of pause, turn off to have the console pause indefinitely)
 - III. ODO Reset (Resets the odometer)
 - IV. Units (Sets the display to readout in English or Metric display measurements)
 - V. Beep (Turns off the speaker so no beeping sound is heard)
 - VI. DA Test (Tests the brake resistance)
4. Security (Allows the keypad to be locked to prevent unauthorized use)

Semi - Recumbent Bike Warranty - Effective August 22, 2018

Spirit Fitness warrants all its Semi - Recumbent Bike parts for a period of time listed below from the date of retail sale, as determined by sale receipt, or in the absence of a sales receipt eighteen (18) months from the original factory shipping date. Spirit Fitness' responsibilities include providing new or remanufactured parts, at Spirit Fitness' option, and technical support to our independent dealers and servicing organizations. In the absence of a dealer or service organization, these warranties will be administered by Spirit Fitness directly to a consumer. The warranty period applies to the following components:

Warranty	Frame	Brake	Parts	Labor
Light Commercial	Lifetime	5 Years	3 Years	1 Year
Residential	Lifetime	Lifetime	10 Years	1 Year

NORMAL RESPONSIBILITIES OF THE CONSUMER

This warranty applies only to products in ordinary household or light commercial use, and the consumer is responsible for the items listed below:

1. The warranty registration card must be completed and returned to the address listed on the card within 10 days of the original purchase to validate the manufacturer's limited warranty.
2. Proper use of the fitness bike in accordance with the instructions provided in this manual
3. Proper installation in accordance with instructions provided with the fitness bike and with all local electric codes.
4. Proper connection to a grounded power supply of sufficient voltage, replacement of blown fuses, repair of loose connections or defects in house wiring.
5. Expenses for making the fitness bike accessible for servicing, including any item that was not part of the fitness bike at the time it was shipped from the factory.
6. Damages to the fitness bike finish during shipping, installation or following installation.
7. Routine maintenance of this unit as specified in this manual.

EXCLUSIONS

This warranty does not cover the following:

CONSEQUENTIAL, COLLATERAL, OR INCIDENTAL DAMAGES SUCH AS PROPERTY DAMAGE AND INCIDENTAL EXPENSES RESULTING FROM ANY BREACH OF THIS WRITTEN OR ANY IMPLIED WARRANTY.

Note: Some states do not allow the exclusion or limitation of incidental or consequential damages, so this limitation or exclusion may not apply to you.

1. Service call reimbursement to the consumer. Service call reimbursement to the dealer that does not involve malfunction or defects in workmanship or material, for units that are beyond the warranty period, for units that are beyond the service call reimbursement period, for fitness bike not requiring component replacement, or fitness bike not in ordinary household use.
2. Damages caused by services performed by persons other than authorized Spirit Fitness service companies; use of parts other than original Spirit Fitness parts; or external causes such as corrosion, discoloration of paint or plastic, alterations, modifications, abuse, misuse, accident, improper maintenance, inadequate power supply, or acts of God.
3. Products with original serial numbers that have been removed or altered.

4. Products that have been: sold, transferred, bartered, or given to a third party.
5. Products that do not have a warranty registration card on file at Spirit Fitness. Spirit Fitness reserves the right to request proof of purchase if no warranty record exists for the product.
6. THIS WARRANTY IS EXPRESSLY IN LIEU OF ALL OTHER WARRANTIES EXPRESSED OR IMPLIED, INCLUDING THE WARRANTIES OF MERCHANTABILITY AND/OR FITNESS FOR A PARTICULAR PURPOSE.
7. Product use in any environment other than a residential setting.
8. Warranties outside of North America may vary. Please contact your local dealer for details.

SERVICE

Keep your bill of sale. Twelve (12) months from the date on the bill of sale or eighteen (18) months from the date of factory shipping as determined by the serial number establishes the labor warranty period should service be required. If service is performed, it is in your best interest to obtain and keep all receipts. This written warranty gives you specific legal rights. You may also have other rights that vary from state to state. Service under this warranty must be obtained by following these steps, in order:

1. Contact your selling authorized Spirit Fitness dealer. OR
2. Contact your local authorized Spirit Fitness service organization.
3. If there is a question as to where to obtain service, contact our service department at (870) 935-1107.
4. Spirit Fitness' obligation under this warranty is limited to repairing or replacing, at Spirit Fitness' option, the product through one of our authorized service centers. All repairs must be preauthorized by Spirit Fitness. If the product is shipped to a service center freight charges to and from the service center will be the customer's responsibility. For replacement parts shipped while the product is under warranty, the customer will be responsible for shipping and handling charges. For in-home service, the customer will be responsible for a trip charge. There will be an additional trip charge if the customer is located over 100 miles from the nearest service center.
5. The owner is responsible for adequate packaging upon return to Spirit Fitness. Spirit Fitness is not responsible for damages in shipping. Make all freight damage claims with the appropriate freight carrier: DO NOT SHIP ANY UNIT TO OUR FACTORY WITHOUT A RETURN AUTHORIZATION NUMBER. All units arriving without a return authorization number will be refused.
6. For any further information, or to contact our service department by mail, send your correspondence to:

Spirit Fitness, Inc.
P.O. Box 2037
Jonesboro, AR 72402-2037

Product features or specifications as described or illustrated are subject to change without notice. All warranties are made by Spirit Fitness, Inc. This warranty applies only in the 48 contiguous United States. NOTE: This does not apply to Alaska or Hawaii.



800.258.4555
spiritservice@spiritfitness.com
www.spiritfitness.com



Spirit Fitness
3000 Nestle Road
Jonesboro, AR 72401

SPIRIT

XBR95 Owners Manual
© 2018 All Rights Reserved
Revision: 08.22.2018