



* Assembly Guide & Warranty Card Included

XC900 ELLIPTICAL OWNER'S MANUAL



Transcend Console



Escalate¹⁵ Console



Escalate⁹ Console



Emerge Console

XC900 ELLIPTICAL OWNERS MANUAL

IMPORTANT:

All Products shown are prototype. Actual product delivered may vary.
Product specifications, features & software are subject to change without notice.
For the most up to date owner's manual please visit www.truefitness.com.
For documents in additional languages please visit www.truefitness.com/document-library/29/international-manuals

IMPORTANTE:

Todos los productos mostrados son prototipos. La realidad el producto suministrado puede diferir.
Especificaciones de productos, características y software están sujetas a cambios sin previo aviso.
Para la más actualizada de este manual del propietario, por favor visite www.truefitness.com
Para los documentos en otros idiomas, por favor visite www.truefitness.com/document-library/29/international-manuals

IMPORTANT:

Tous les produits présentés sont prototype. Le produit réel livré peut varier.
Spécifications du produit, caractéristiques et logiciels sont sujettes à modification sans préavis.
Pour la plus à jour le manuel du propriétaire s'il vous plaît visitez www.truefitness.com.
Pour documents dans des langues supplémentaires, veuillez www.truefitness.com/document-library/29/international-manuals de visite

重要提示：

显示所有产品的原型。实际交付的产品可能有所不同
产品规格，功能和软件如有更改，恕不另行通知
迄今为止对于大多数的使用说明书，请访问www.truefitness.com
对于其他语言的文档，请访问www.truefitness.com/document-library/29/international-manuals

هام:

جميع المنتجات المعروضة هي النموذج. قد تختلف المنتج الفعلي تسليمها.
مواصفات المنتج، والميزات والبرامج قابلة للتغيير دون إشعار.
www.truefitness.com ما يصل حتى الآن دليل المالك يرجى زيارة
www.truefitness.com/document-library/29/international-manuals للمستندات في لغات إضافية، يرجى زيارة

WICHTIG:

Alle hier gezeigten Produkte sind Prototypen. Das tatsächliche Produkt ausgeliefert wird, kann variieren.
Produkt-Spezifikationen, Funktionen und Software können sich ohne vorherige Ankündigung ändern.
In den meisten Fällen bis zu Bedienungsanleitung Bisher besuchen Sie bitte www.truefitness.com.
Für Dokumente in weiteren Sprachen finden Sie unter www.truefitness.com/document-library/29/international-manuals

BELANGRIJK:

Alle getoonde producten zijn prototype. Daadwerkelijke product geleverd kan verschillen.
Product specificaties, eigenschappen & software zijn onderhevig aan verandering zonder kennisgeving.
Voor de meest actuele handleiding van de eigenaar kunt u terecht www.truefitness.com.
Voor documenten in andere talen kunt u terecht op www.truefitness.com/document-library/29/international-manuals

ВАЖНО:

Все товары указаны прототипа. Фактический продукт, поставляемый могут отличаться.
Технические характеристики, особенности и программного обеспечения могут быть изменены без предварительного уведомления.
Для получения самой последней на сегодняшний день руководство по эксплуатации пожалуйста, посетите www.truefitness.com
Для документов на другие языки, пожалуйста, посетите www.truefitness.com/document-library/29/international-manuals

XC900 ELLIPTICAL OWNERS MANUAL

Frank Trulaske began TRUE Fitness over thirty-five year ago with the simple philosophy of delivering superior fitness products, service and support. Today, TRUE is the global leader in premium fitness equipment for the commercial and residential markets. Our goal is to be the leader in technology, innovation, performance, safety and style. TRUE has received many awards for its product over the years and remains the benchmark for the industry. Fitness facilities and consumers invest in TRUE products for their durable commercial platforms used in all its products, both commercial and residential alike.

The proud manufacturing tradition of quality and the culture of innovation at TRUE have given rise to a full line of extraordinary cardio and strength equipment. As a result, people all over the world are benefiting from the TRUE experience. Innovation across the full product line has made TRUE successful and is a trademark of the TRUE heritage. TRUE's patented Heart Rate Control technology is just one of the remarkable ways we deliver simple and superior performance every user can enjoy, and most importantly, use to achieve personal health and fitness goals.

At the heart of our success is the relentless and systematic life testing of both our products and their components. We have dedicated employees who understand our philosophy is to deliver the best products in the world.

Our goal is to deliver the world's best premium equipment for our customers' health and fitness solutions.

XC900 ELLIPTICAL OWNERS MANUAL

TABLE OF CONTENTS:

Chapter 1: Safety Instructions

Safety Instructions.....	1
Space Requirements.....	3
Grounding Instructions.....	4
Power Requirements.....	5
Warning Decals.....	6
Compliances.....	6

Chapter 2: Assembly Instructions

Pre Assembly Checklist.....	7
Elliptical Assembly Steps.....	8
Wiring Diagrams.....	22

Chapter 3: Product Overview

Elliptical Overview.....	24
--------------------------	----

Chapter 4: Programming & Operation

Heart Rate Monitoring.....	26
Heart Rate Control.....	24
Program Descriptions.....	26
Virtual Active® Videos.....	30

Chapter 4A: Transcend Operation

Transcend Overview.....	34
Touchscreen Introduction.....	36
Touchscreen Navigation.....	36
Web Browser.....	43
iPod® Integration.....	44
Bluetooth Audio.....	45
TV Controls.....	47
Virtual Active®.....	48
Advanced Console Functions.....	49

Chapter 4B: Escalate¹⁵ Operation

Escalate ¹⁵ Overview.....	66
Console Navigation.....	68
TV Controls.....	73
iPod® Integration.....	74
Bluetooth Audio.....	75
Advanced Console Functions.....	77

Chapter 4B: Escalate⁹ Operation

Escalate ⁹ Overview.....	93
Console Navigation.....	95
Advanced Console Functions.....	102

Chapter 4B: Emerge Operation

Emerge Overview.....	111
Console Navigation.....	113
Advanced Console Functions.....	116

Chapter 5: Care & Maintenance

Care & Maintenance.....	121
Cleaning the Equipment.....	121
Other Scheduled Preventive Maintenance.....	122
Long Term Storage.....	122

Chapter 6: Customer Service

Contacting Service.....	123
Contacting Sales.....	123
Reporting Freight Claims or Parts Damage.....	124



Chapter 7: Additional Information

Troubleshooting Guide.....	125
Specification Sheet.....	128
Warranty Registration.....	130









CHAPTER 1: SAFETY INSTRUCTIONS

IMPORTANT SAFETY INSTRUCTIONS SAVE THESE SAFETY INSTRUCTIONS

This elliptical is intended for a commercial or institutional setting. This owner's manual should be accessible to all personal trainers, staff members, and members.

-  WARNING: All EXERCISERS MUST READ ALL INSTRUCTIONS BEFORE USING THE ELLIPTICAL.
-  WARNING: Heart rate monitoring systems may be inaccurate for some individuals. Over-exercising may result in serious injury or death. If you feel faint, stop exercising immediately.
-  WARNING: Equipment should be immediately taken out of use if it fails to work properly or when a warning is presented electronically.

TRUE STRONGLY recommends seeing a physician for a complete medical exam before undertaking an exercise program, particularly if the user has a family history of high blood pressure or heart disease, is over the age of 45, smokes, has high cholesterol, is obese or has not exercised regularly in the past year. Additionally, TRUE recommends consulting a fitness professional on the correct use of this product. If at any time while exercising the user experiences faintness, dizziness, pain or shortness of breath, he or she must stop immediately.

-  WARNING: To reduce the risk of electrical shock, always unplug this TRUE product before cleaning or attempting any maintenance activity. Do not handle the plug with wet hands.
-  WARNING: To reduce the risk of burns, fire, electric shock or injury, it is imperative to connect each product to a properly grounded 110V electrical outlet. A risk of electrical shock may result from improper connection of the equipment's grounding conductor. Check with a qualified electrician if you are unsure about proper grounding techniques. Do not modify the plug provided with this product. If it will not fit an electrical outlet, have a proper outlet installed by a qualified electrician. Your TRUE Fitness product must be properly grounded to reduce risk of shock if the elliptical malfunctions. Your elliptical may be equipped with an electrical cord, which includes an equipment grounding conductor and a grounding plug. The plug must be inserted into an outlet that has been properly installed and grounded in accordance with all local codes and ordinances. A temporary adapter cannot be used to connect this plug to a two-pole receptacle in North America. If a properly grounded 15 amp outlet is not available, a qualified electrician must install one.
-  WARNING: Do not move the equipment by lifting the console. Do not use the console as a handlebar during a workout.
-  WARNING: This product contains chemicals known to the state of California to cause cancer and birth defects or other reproductive harm.
-  WARNING: Keep equipment stable on flat ground.
-  WARNING: Replace warning labels that may be worn, damaged or missing.
-  WARNING: Replace any non-working or damaged components; remove the unit from service until repair is performed.
-  WARNING: To reduce the risk of burns, fire and electric shock or injury to persons, follow these instructions:
 - This appliance should never be left unattended when plugged in.
 - Do not use any type of extension cord with this product.
 - Unplug it from the outlet when not in use and before any servicing.
 - Do not operate the equipment while being covered with a blanket, plastic, or anything that insulates or stops airflow.

CHAPTER 1: SAFETY INSTRUCTIONS

 **WARNING:** Risk of personal injury-crushing hazard when elliptical is in operation - Keep feet, hands, and fingers away from moving parts.

CAUTION:

- Health related injuries may result from incorrect or excessive use of exercise equipment.
- Do not use typing or web surfing features at excessive speeds. Always stabilize yourself by holding a stationary handle when using typing or web surfing features. (Varies by console option)
- Do not use the contact heart rate grips as a handlebar during a workout.
- Any changes or modifications to this equipment could void the product warranty.
- To avoid injury stand on the side rails before starting the elliptical.
- To disconnect, turn power OFF at the ON/OFF switch if applicable, then remove plug from electrical outlet.
- Never operate a TRUE product if it has a damaged power cord or electrical plug, or if it has been dropped, damaged, or even partially immersed in water. Contact TRUE Customer Service.
- Your commercial elliptical is self-generated and does not require the use of an electrical outlet with the LED console. Optional TFT or touch screen consoles require 110V AC input and 9V DC 1.5Amp output for console operation only.
- The batteries within self-generated equipment contain materials that are considered hazardous to the environment. Federal law requires proper disposal of these batteries.
- Use a TRUE AC power cord or AC/DC adapter only
- Note the plug configuration for the power adapter may vary by country.
- Position this product so the power cord plug is accessible to the user.
- Keep the power cord away from heated surfaces. Do not pull the equipment by the power cord or use the cord as a handle. Do not run the power cord along the side or under the treadmill.
- If the electrical supply cord is damaged it must be replaced by the manufacturer, an authorized service agent, or a similarly qualified person to avoid a hazard.
- Do not use this product in areas where aerosol spray products are being used or where oxygen is being administered. Such substances create the danger of combustion and explosion.
- Always follow the console instructions for proper operation. Close supervision is necessary when used near children under the age of 15, or disabled persons.
- Do not use this product outdoors, near water, while wet, or in areas of high humidity including extreme temperature changes.
- Never operate a TRUE product with the air openings blocked. Keep air openings free of lint, hair or any obstructing material.
- Never insert objects into any openings in this product. If an object should drop inside, turn off the power, unplug the power cord from the outlet and carefully retrieve it. If the item cannot be reached, contact TRUE Customer Service.
- Never place liquids of any type directly on the unit except in the accessory tray or bottle holders. Containers with lids are recommended.
- Wear shoes with rubber or high traction soles. Do not use shoes with heels, leather soles, cleats or spikes. Make sure no stones are embedded in the soles. Do not use this product in bare feet. Keep all loose clothing, shoelaces and towels away from moving parts.
- Do not reach into or underneath the unit, or tip it on its side during operation.
- Use correct ergonomic positioning while operating the elliptical.
- Do not allow animals on or near the equipment while in operation.

CHAPTER 1: SAFETY INSTRUCTIONS

- Use the side rails or upper exercise arms whenever additional stability is required. In case of emergency, the side rails should be grabbed and the user should place his/her feet on the side platforms. The side rails should be used to grasp the heart rate sensors or to rest the hand on while operating the activity zone keys.
- Do not exceed maximum user weight of 400 lbs. (181 kg).
- Avoid exiting elliptical while the foot skate is still in motion
- Do not use if you have a cold or fever.
- When using this exercise machine, basic precautions should always be followed.
- Use this elliptical only for its intended use as described in this manual.
- Do not use attachments not recommended by the manufacturer.
- Allow only trained personnel to service this equipment.
- Avoid the possibility of bystanders being struck or caught between moving parts by making sure that they are out of reach of the elliptical while it is in motion.
- Allow only one person at a time on the elliptical while it's operating.
- It is the sole responsibility of the owner/operator to ensure regular and scheduled maintenance is performed.
- This appliance can be used by children aged from 8 years and above and persons with reduced physical, sensory or mental capabilities or lack of experience and knowledge if they have been given supervision or instruction concerning use of the appliance in a safe way and understand the hazards involved.
- Children shall not play with the appliance.
- Cleaning and user maintenance shall not be made by children without supervision.
- Avoid placing hands on the upper side rail covers while elliptical is in operation. (See Fig 2)

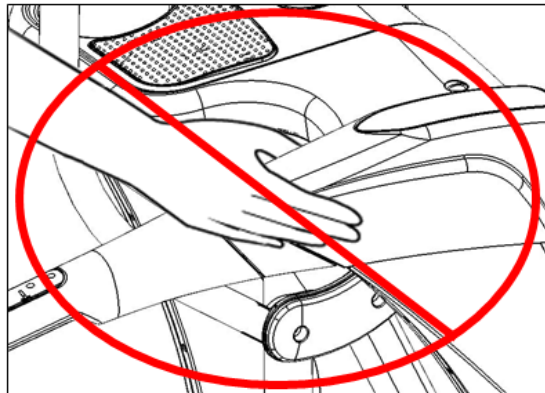
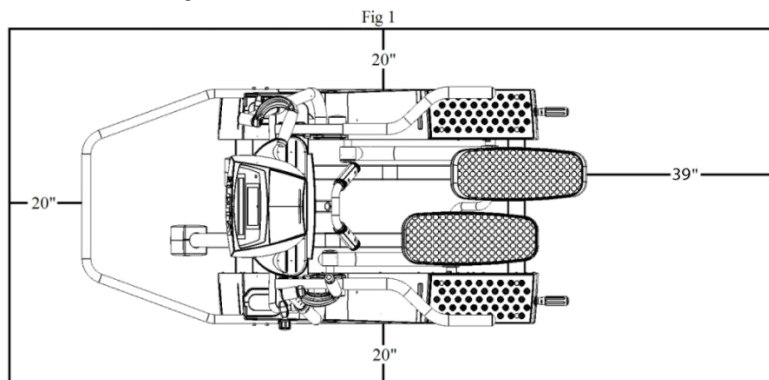

Fig 2

SPACE REQUIREMENTS:

- TRUE's recommendation is to leave a 39" safety zone at rear of elliptical. The sides of the unit should be at least 20" away from the wall or obstructions. (See Fig 1)



CHAPTER 1: SAFETY INSTRUCTIONS

GROUNDING INSTRUCTIONS:

This product must be grounded, if it should malfunction or breakdown, grounding provides a path of least resistance for electric current to reduce the risk of electric shock. This product is equipped with a cord having an equipment-grounding conductor and a grounding plug. The plug must be plugged into an appropriate outlet that is properly installed and grounded in accordance with all local codes and ordinances.

DANGER:

- Improper connection of the equipment-grounding conductor can result in a risk of electric shock.
- Check with a qualified electrician or serviceman if you are in doubt as to whether the product is properly grounded. Do not modify the plug provided with the product. If it will not fit the outlet, have a proper outlet installed by a qualified electrician.
- Do not remove the motor cover or you may risk injury due to electric shock.
- The 120-V model is for use on a nominal 120-V circuit and has a grounding plug that looks like the plug illustrated in figure A. Make sure the product is connected to an outlet having the same configuration as the plug. No adaptor should be used with this product.
- The 230-V model is for use on a circuit having a nominal rating more than 120-V and is factory-equipped with a specific electric cord and has a grounding plug that looks like the plug illustrated in figure B. Make sure that the product is connected to an outlet having the same configuration as the plug in Figure B. No adapter should be used with this product. If the product must be reconnected for use on a different type of electric circuit, the reconnection should be made by qualified service personnel

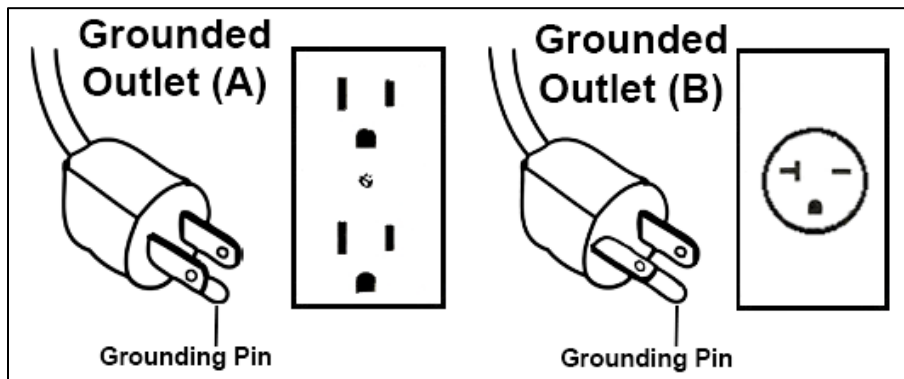

CHAPTER 1: SAFETY INSTRUCTIONS

POWER REQUIREMENTS FOR TRUE PRODUCTS

Information Sheet 2010

NOTE: Read and understand all instructions on this sheet and in the Owner's manual before plugging any TRUE power cord into an electrical outlet. This information sheet will help you identify the voltage and cords you need where you live and will outline requirements for:

- Grounded, dedicated lines
- Voltage
- Power cords
- Power adapters
- Extension cords

!DANGER: Improper connection of the equipment-grounding conductor can result in risk of electric shock. Check with a qualified electrician or service provider if you are in doubt as to whether the equipment is properly grounded or installed on a dedicated line. Seek a qualified electrician to perform any modifications to the cord or plug. TRUE is not responsible for injuries or damages as a result of cord or plug modification.

!CAUTION: Place cords away from heat (such as baseboards). Use care to arrange any cord so it doesn't become an obstacle.

Extension Cords

Do not use an extension cord to supply power to any TRUE product.

Grounded, Dedicated Line

TRUE equipment must be grounded. If it should malfunction or break down, grounding provides a path of least resistance for electric current to reduce the risk of electric shock. TRUE cords (except for cycle adapters) have an equipment-grounding conductor and a grounding plug. The plug must be plugged into an appropriate outlet that is properly installed and grounded in accordance with all local codes and ordinances where you live. Do not use a ground plug adapter to adapt the power cord to a non-grounded outlet. Do not use a GFCI outlet or GFCI circuit breaker. A dedicated line will assure that adequate power is available for safe operation over the life of your TRUE Product.

Voltage

Voltage required for your unit is located on the serial number decal (usually on the front of the unit). Depending on where you live voltage requirements differ.

For example, in the United States some TRUE treadmills require a circuit rated 115 VAC, 60 Hz and 20 amps. See Figure 1. However, a home typically has 15 amp outlets. In this case, contact an electrician to install a 20 amp dedicated line prior to use. See Figure 2.

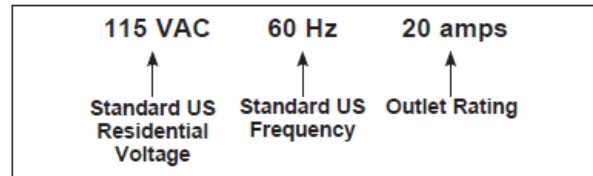

Figure 1

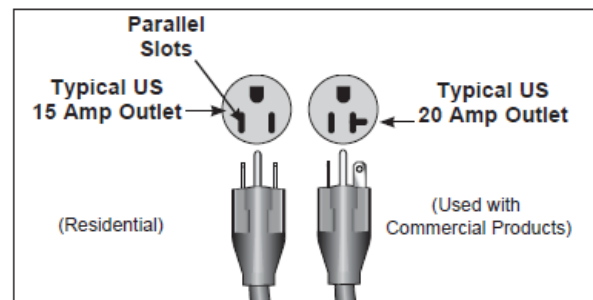

Figure 2

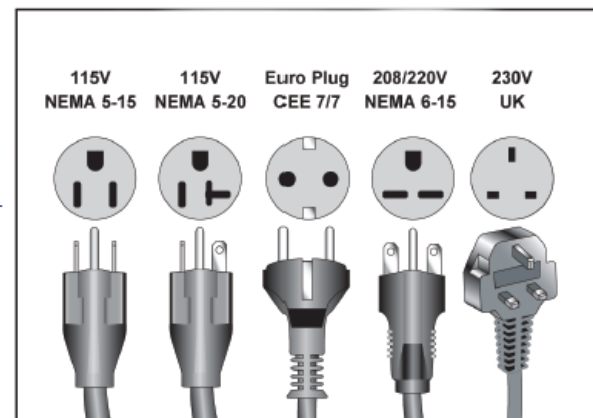

Figure 3

CHAPTER 1: SAFETY INSTRUCTIONS

WARNING DECALS:

 **WARNING:** Replace warning labels that may be worn, damaged or missing.

*To replace any worn or missing warning decals contact TRUE FITNESS by one of the following: www.truefitness.com or contact customer service at 800-883-8783.

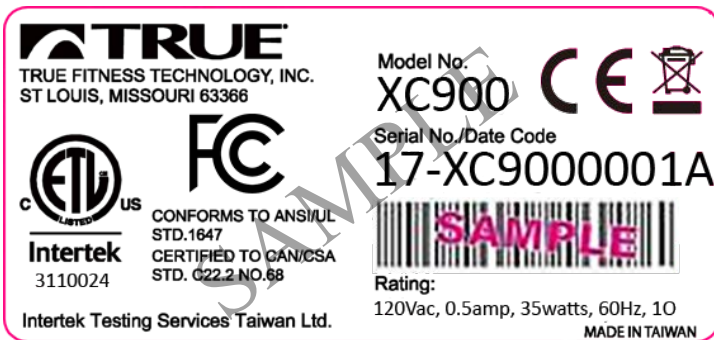
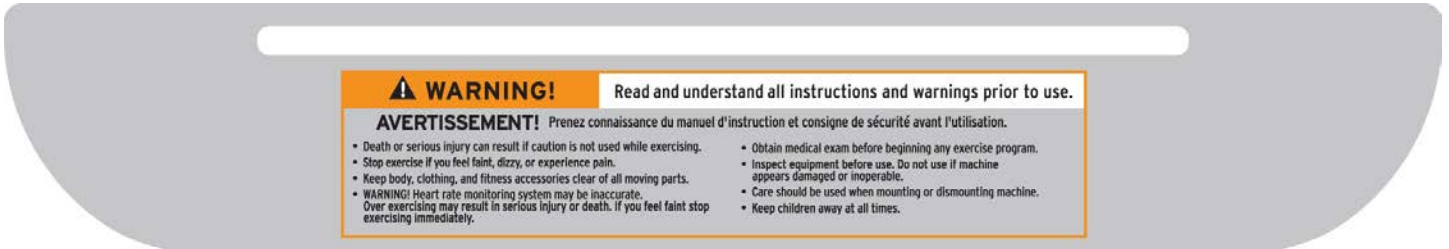

COMPLIANCES:

This equipment complies with all applicable codes and regulations. For a complete list of compliances, please visit www.truefitness.com.

CHAPTER 2: ASSEMBLY INSTRUCTIONS

IMPORTANT SAFETY INSTRUCTIONS

- **Read and understand all instructions and warnings prior to use.**
- Obtain a medical exam before beginning any exercise program. If at any time during exercise you feel faint, dizzy, or experience pain, stop and consult your physician.
- Obtain proper instruction prior to use.
- Inspect the elliptical for incorrect, worn, or loose components and do not use until corrected, replaced, or tightened prior to use.
- Do not wear loose or dangling clothing while using elliptical.
- Care should be used when mounting or dismounting elliptical.
- Disconnect all power (if applicable) before servicing elliptical.
- Do not exceed maximum user weight of 400 lbs.
- Keep children and animals away.
- Do not operate an electrically powered elliptical in damp or wet locations.
- All exercise equipment is potentially hazardous. If attention is not paid to the conditions of equipment usage, death, or serious injury could occur.
- Keep the top side of the moving surface clean and dry.

*Should you need technical assistance in assembly of your TRUE Fitness product, contact TRUE Fitness Technical Support at 1-800-883-8783.

PRE-ASSEMBLY CHECK LIST:

Tools Required:

10mm hex key (Included)
8mm hex key (Included)
6mm hex key (Included)
#2 Phillips Screwdriver
17 mm socket

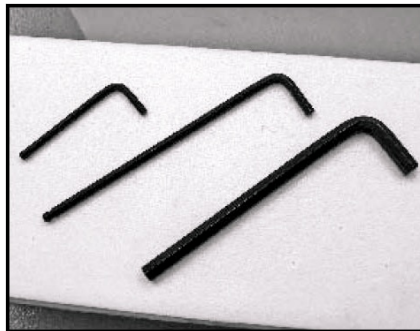

Hardware:

Hardware is packaged in numbered plastic bags that correspond to the step with which they are used. Not all steps require hardware.

CHAPTER 2: ASSEMBLY INSTRUCTIONS

ELLIPTICAL ASSEMBLY STEPS:

⚠ CAUTION:

- It is recommended that two people unpack and assemble elliptical.
- Remove bands from packaging and pull top from pallet.
- Remove all parts from packaging. Leave machine on pallet.
- For each step use hardware in the corresponding bag.

Parts Identification:

Use this page to identify the parts used in each step.

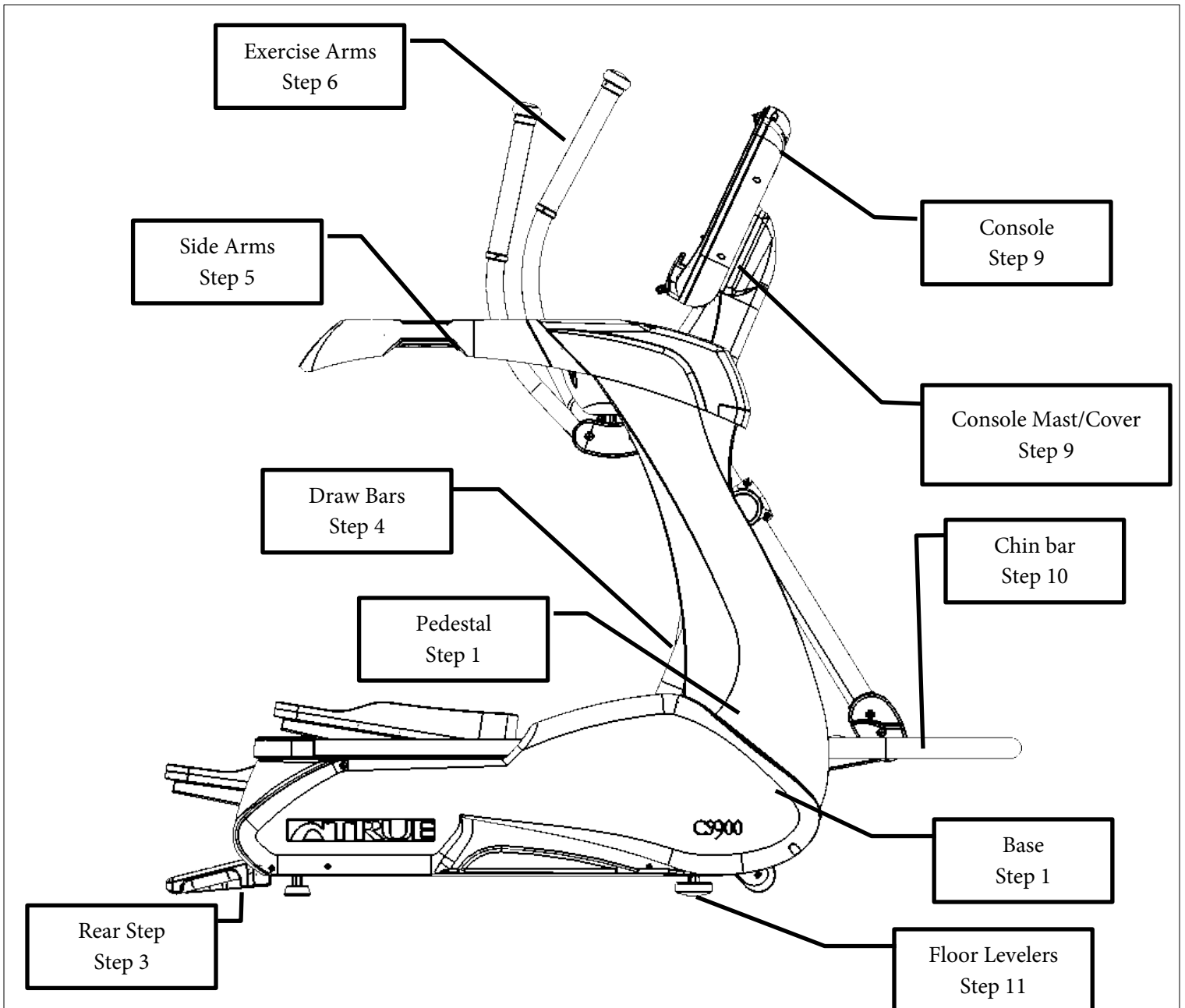

CHAPTER 2: ASSEMBLY INSTRUCTIONS

ELLIPTICAL ASSEMBLY STEPS:

Measure Doorways:

Measure all doorways, hallways and stairwells to make sure that the 34" frame can fit through them. If it will not fit, move all parts to the final location and assemble machine in that location. If the machine needs to be placed on its side, keep the left side Styrofoam attached to the Base to help avoid damaging the plastic covers.

Please Note When Moving The Elliptical:

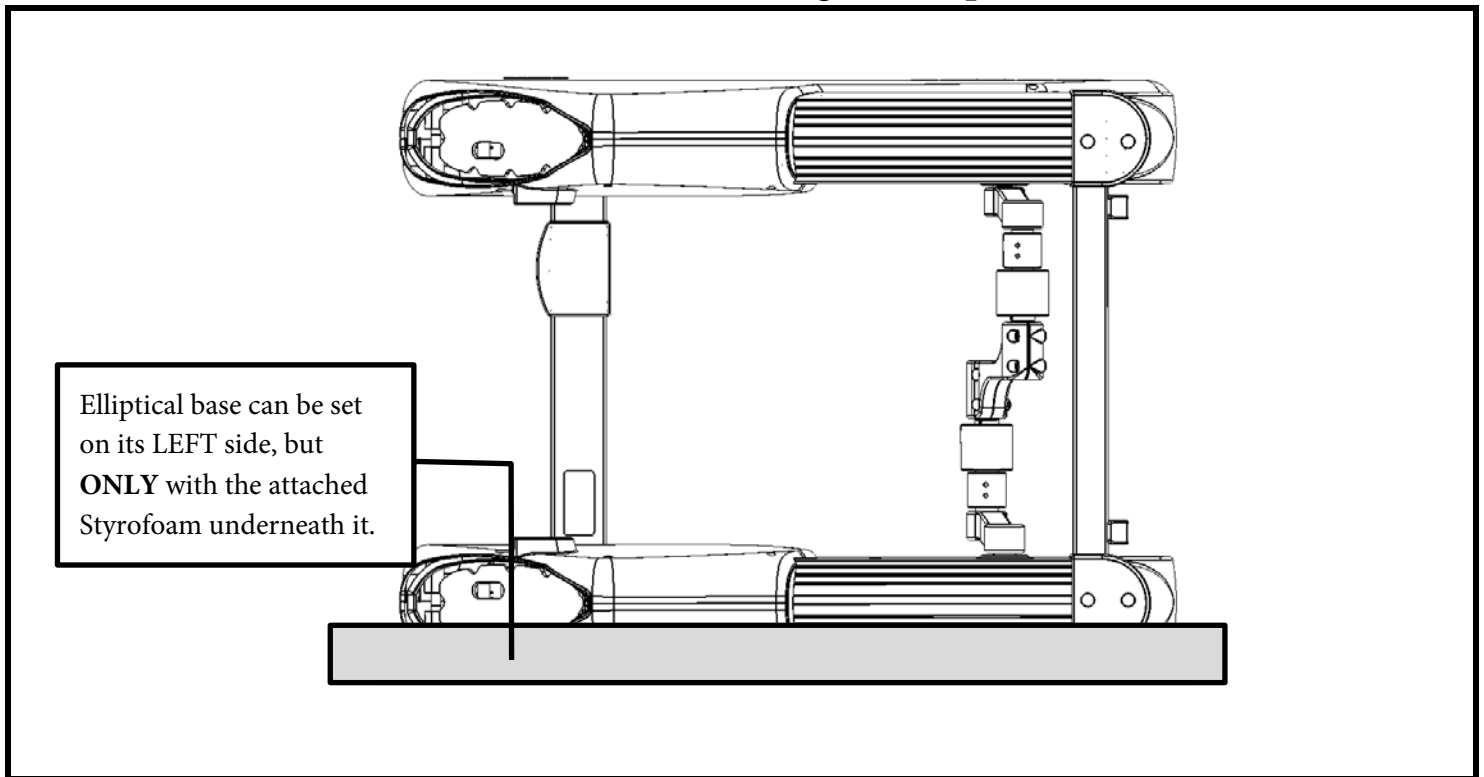

CHAPTER 2: ASSEMBLY INSTRUCTIONS

ELLIPTICAL ASSEMBLY STEPS (CONTINUED):

STEP 1: Assemble Pedestal to Base:

a) Remove 3 screws in order to remove inner shroud from both inner sides.

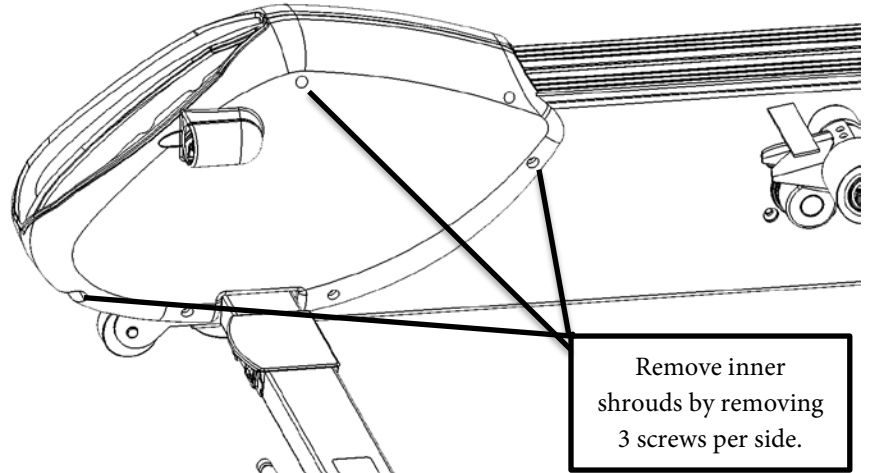

b) Remove the twist tie from the Rubber seal and slide it up over the weld beads to its correct location. Make sure “Up” tab is facing up on the rear of the machine.

NOTE: The rubber seal is for perspiration deflection and should sit below the plastic covers.

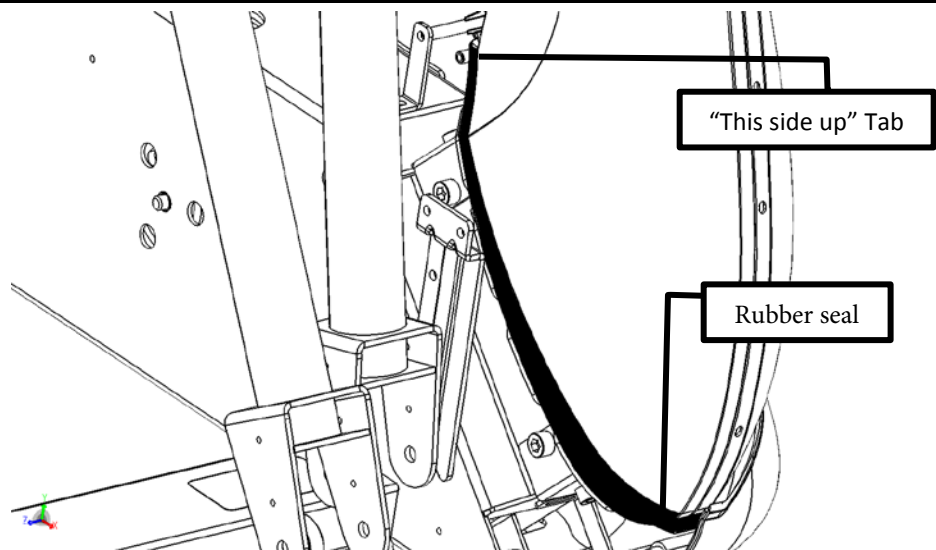

c) Use 2 people to slide the Pedestal straight down onto the Base and be careful to not pinch the wires on the right side of the base.

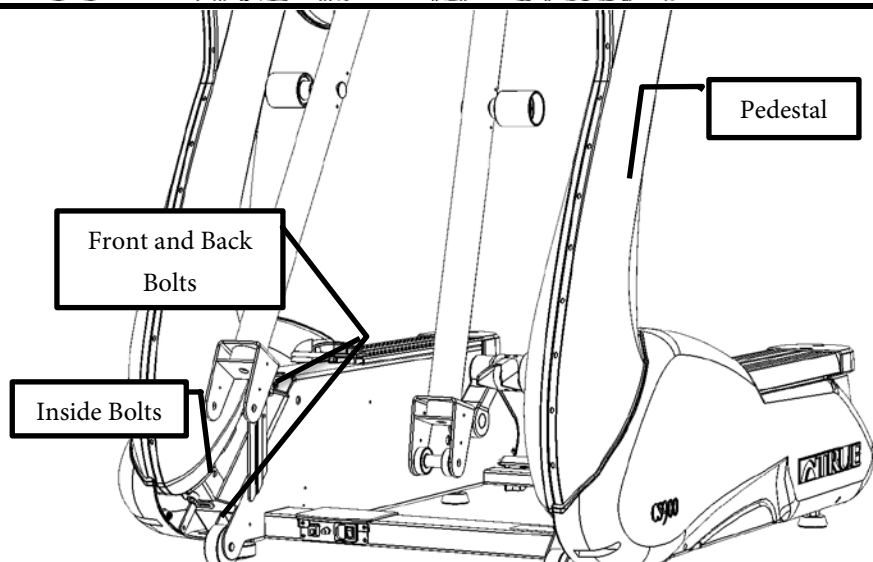

CHAPTER 2: ASSEMBLY INSTRUCTIONS

ELLIPTICAL ASSEMBLY STEPS (CONTINUED):

STEP 1: Assemble Pedestal to Base (continued):

d) To secure the Pedestal to the Base, use 2 M10x70mm bolts on the inside and 4 M10x20mm bolts on the front and back. Do this for both sides.

*Do NOT pinch wires!

Hardware Required (Bag 2) :



4 M10x20mm Bolts

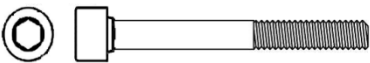

2 M10x70mm Bolts

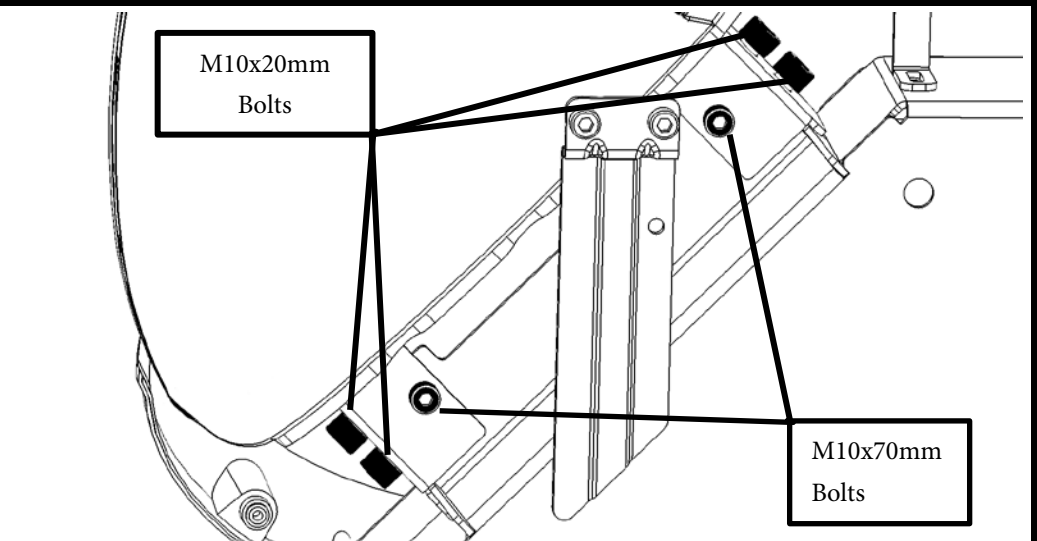

e) Connect Wires coming out of the bottom right side of pedestal to the corresponding wires coming out of the frame.

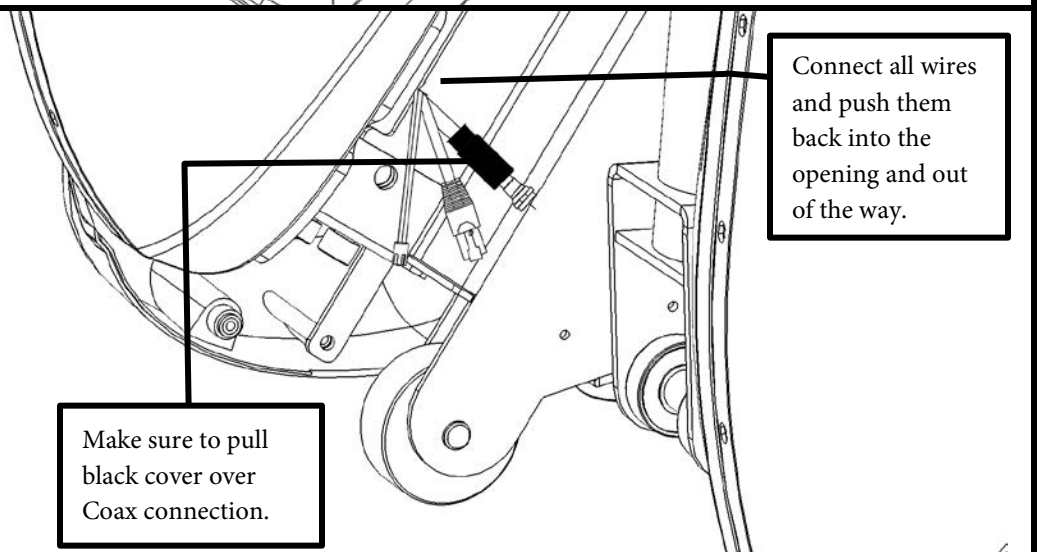

STEP 2 Attach Inner Shrouds:

a) Make sure wires are tucked away before attaching inner shrouds.

b) Use two M4x16mm screws and four M5x12 screws per side to attach inner shrouds.

Hardware Required (Bag 2):



8 M5x12mm Screws



4 M5x16mm Screws

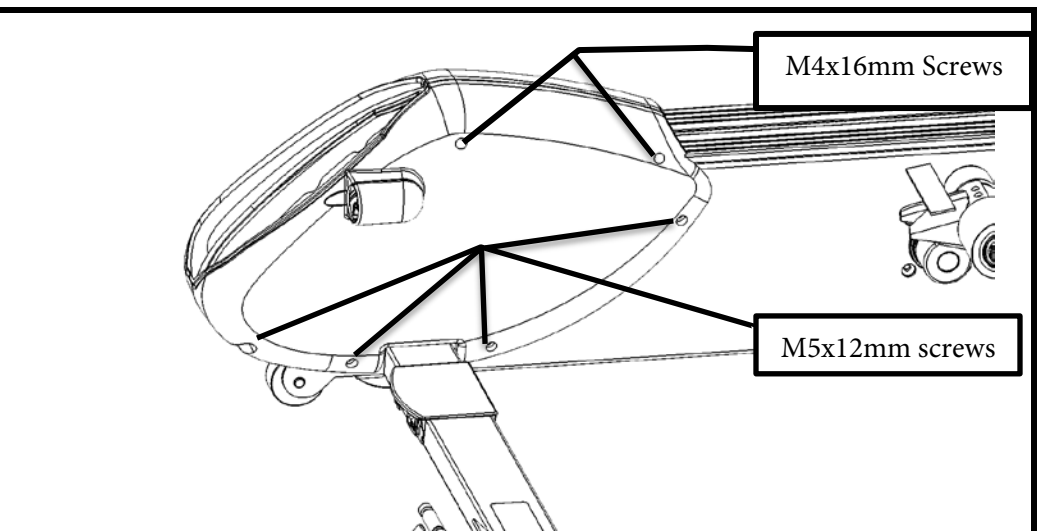

CHAPTER 2: ASSEMBLY INSTRUCTIONS

ELLIPTICAL ASSEMBLY STEPS (CONTINUED):

STEP 3 Attach Rear Step:

- Insert the step weldment into the rear openings making sure the screw holes face up.
- Using the 2 M10x50 bolts and 2 M10 nuts, attach the weldment.
- Attach the plastic step using the 4 M5x12 stainless bolts.

Hardware Required (Bag 3):

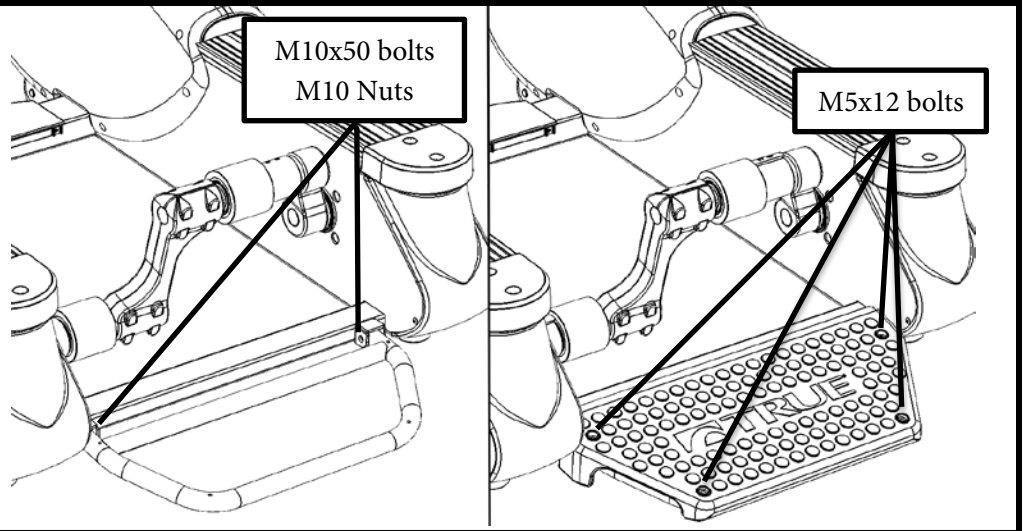
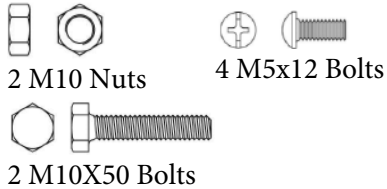

STEP 4: Attach Draw Bars: *Drawbars are labeled "L" for left and "R" for right

- Slide correct drawbar onto corresponding shaft.
- Install, but do not tighten a M10 bolt, lock washer, and flat washers with 17mm socket and wrench.
- Repeat these steps for both sides.

Hardware Required (Bag 4):

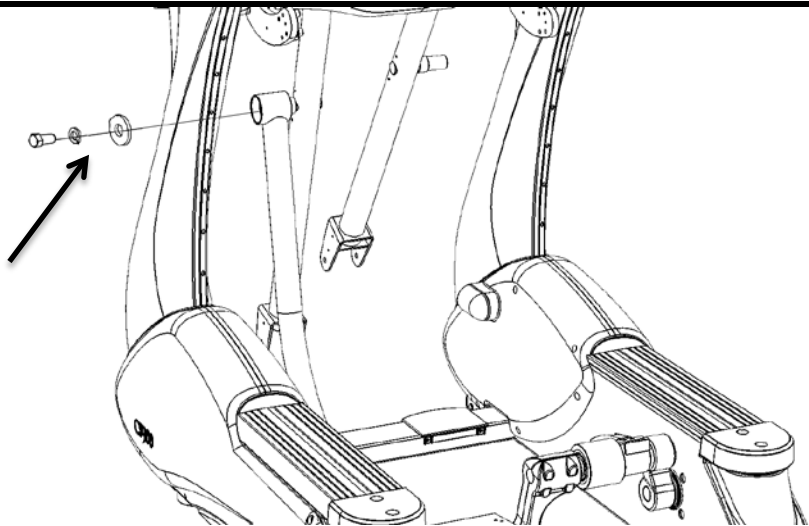
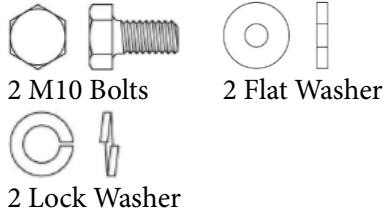

- Secure bottom of drawbars using 4 M8x 12 bolts and 4 M8 curved washers.
- Once all bolts are started, tighten bottom bolts with 6mm allen wrench and top bolts with 17mm socket and wrench.

Hardware Required (Bag 4):

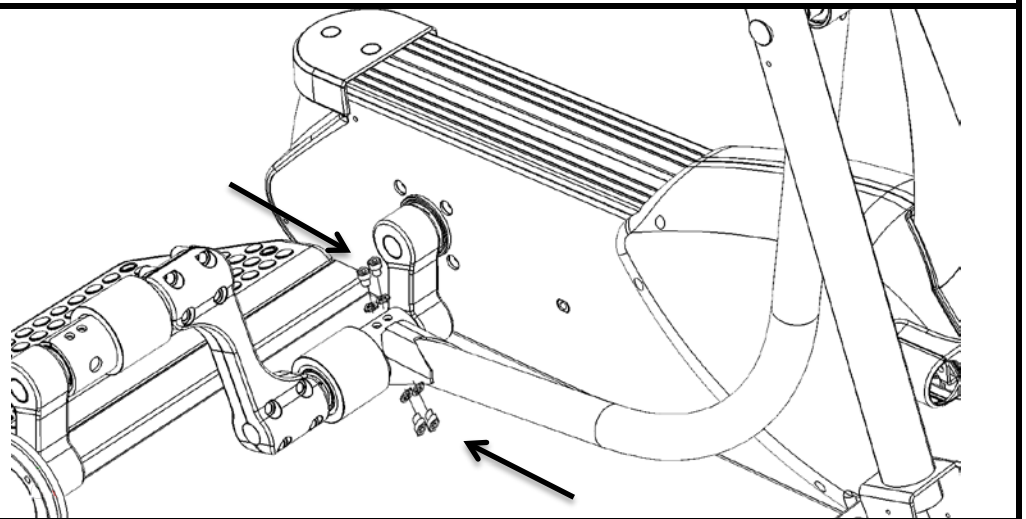
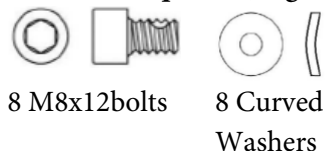

CHAPTER 2: ASSEMBLY INSTRUCTIONS

ELLIPTICAL ASSEMBLY STEPS (CONTINUED):

STEP 4: Attach Draw Bars (continued): *Shrouds are marked "L" for left and "R" for right on inside of part

a) Attach middle covers with 2 M5x12 and 3 M3x12 screws.

b) Repeat this step for both sides

Hardware Required (Bag 4):



6 M3x12 Screws



4 M5x12 Screws

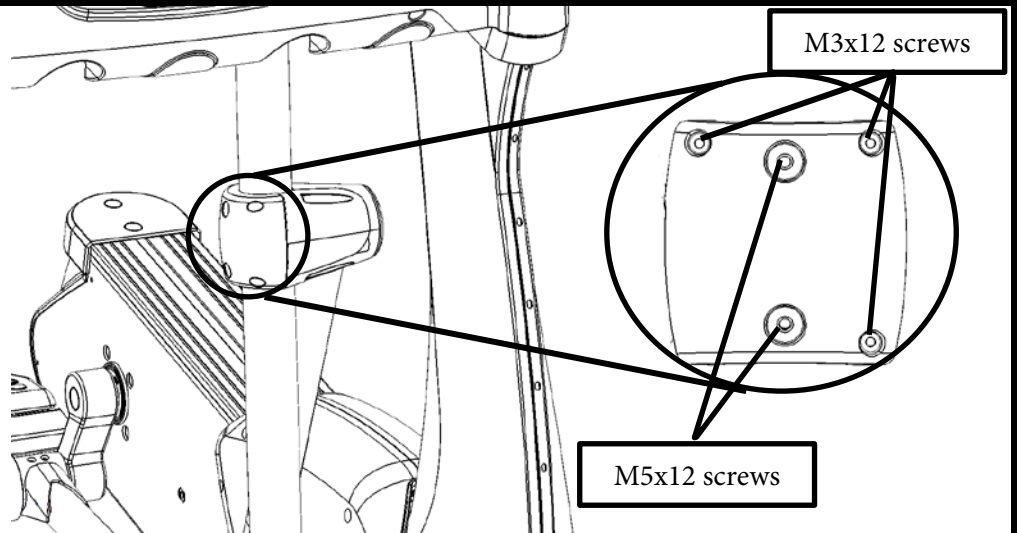

STEP 5: Attach Side Arms:

a) Connect Cardio Arm Heart Rate Cable.

b) **CAREFULLY** slide Side Arm into Pedestal and tuck the Heart Rate Cable into the metal tube. Make sure to not pinch the Heart Rate Cable wires.

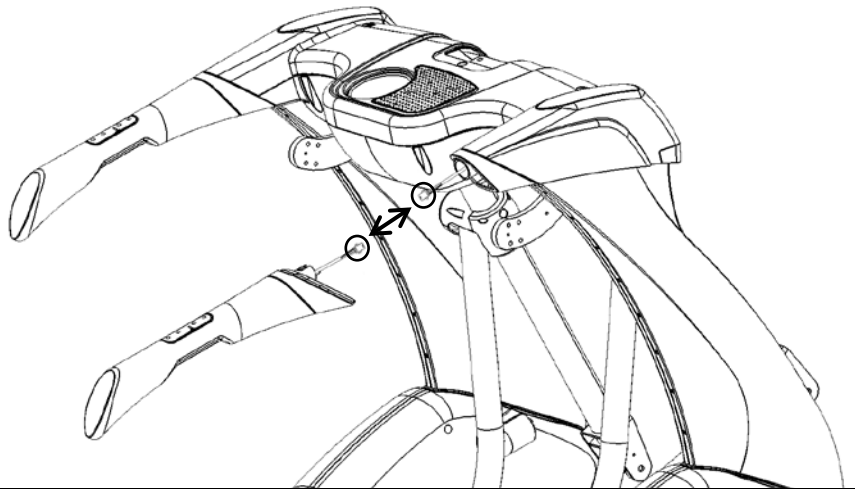

c) Use 2 M8x12mm bolts on each side to tighten the Side Arms into the underside of the Pedestal.

Hardware Required (Bag 5):



4 M8x12bolts

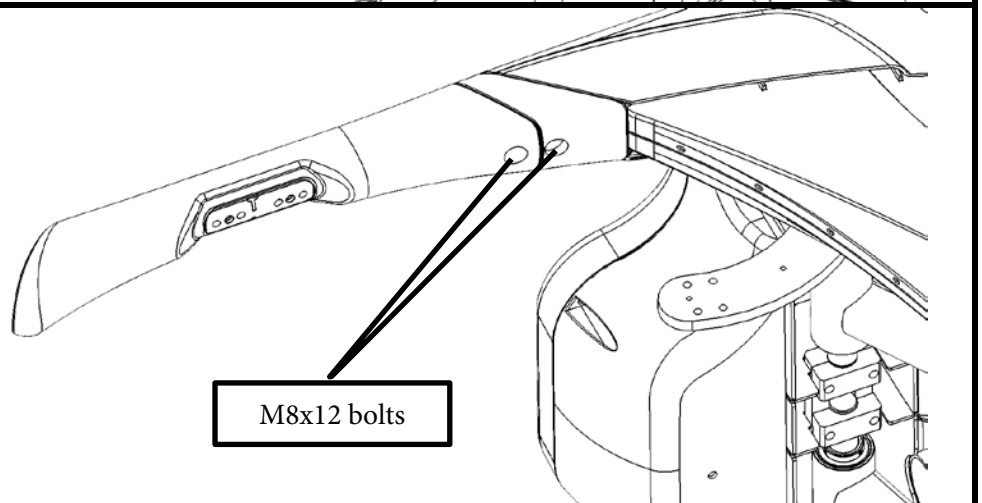

CHAPTER 2: ASSEMBLY INSTRUCTIONS

ELLIPTICAL ASSEMBLY STEPS (CONTINUED):

STEP 6: Attach Upper Body Cardio Arms: * upper arms are labeled “L” for Left and “R” for Right.

a) Install each upper arm with 4 M8x1.25x16mm bolts using a 6mm hex key. **Hardware**

Required (Bag 6):



8 Tapered M8x16mm Bolts

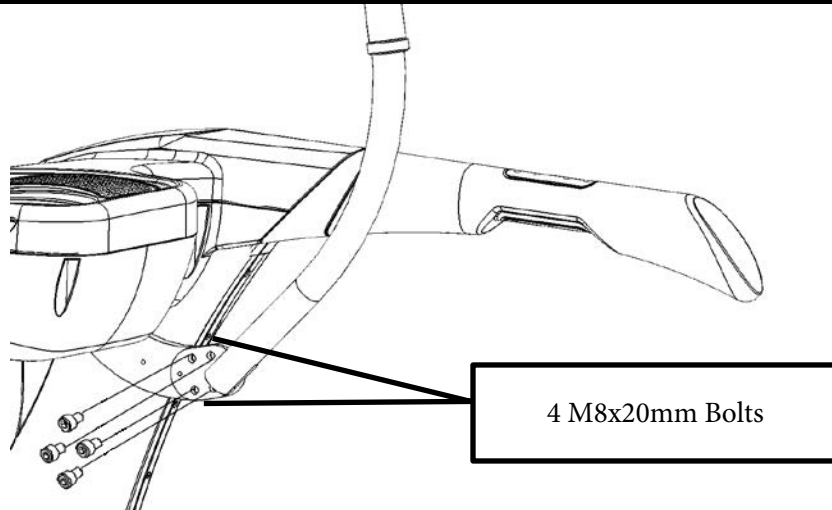

b) Attach the Cardio Arm Covers using 4 M5x8mm screws per side.

Hardware Required (Bag 6):



8 M5x8 Screws

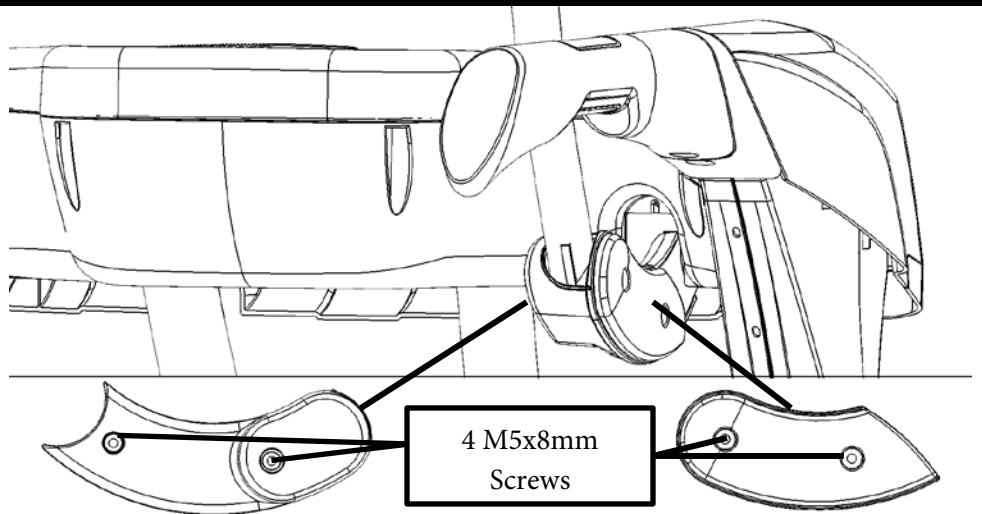

STEP 7: Attach Pedal Tubes:

a) Use 2 M10x80mm bolts and 2 M10 Nuts to attach Pedal Tubes. Make sure that Pedal Tubes are centered on the rollers on the Crankshaft before tightening the bolts.

Hardware Required (Bag 7):

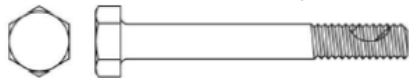

2 M10x80mm Bolts



2 M10 Nuts

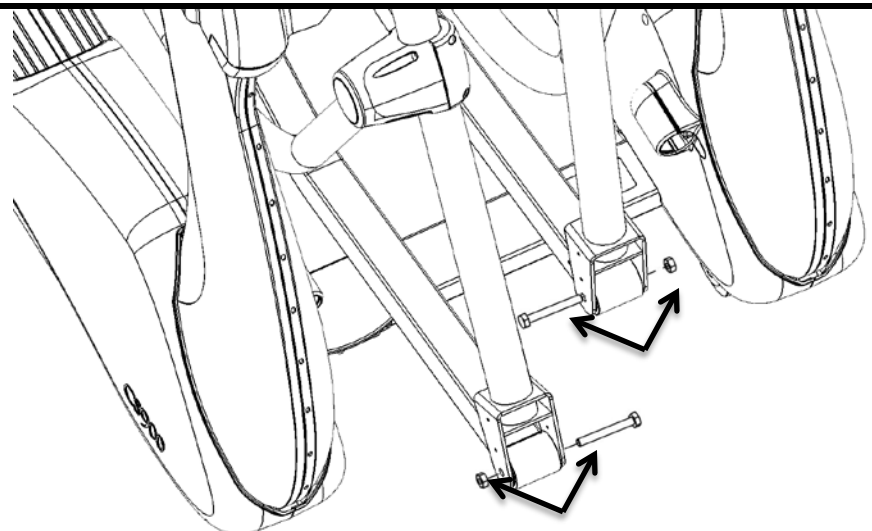

CHAPTER 2: ASSEMBLY INSTRUCTIONS

ELLIPTICAL ASSEMBLY STEPS (CONTINUED):

STEP 7: Attach Pedal Tubes (continued):

b) Attach the Front Pedal Tube Covers using 8 M5x12mm screws.

Hardware Required (Bag 7):



8 M5x12mm Screws

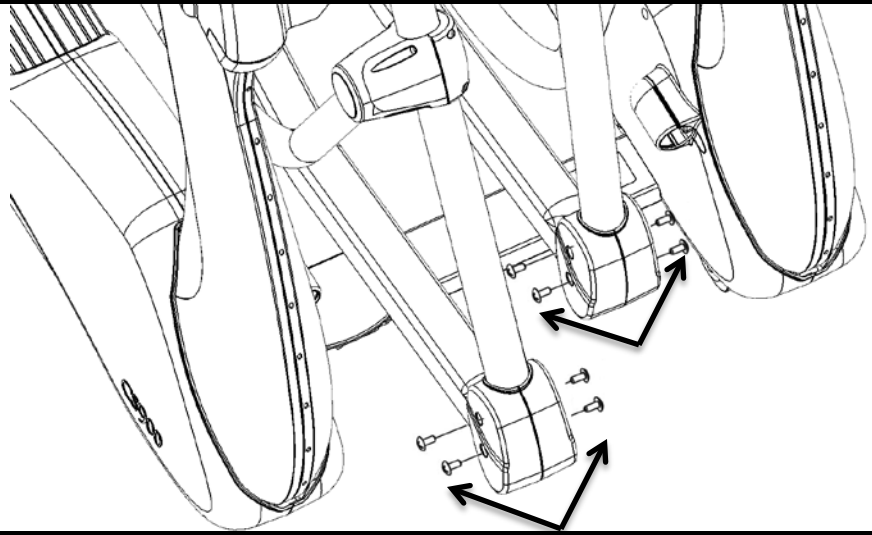

STEP 8: Attach Console Mast:

a) Slide Console cables through Console Mast (and attach Mast using 4 M8x 20mm bolts).

Hardware Required (Bag 8):



4 M8x20mm Bolts

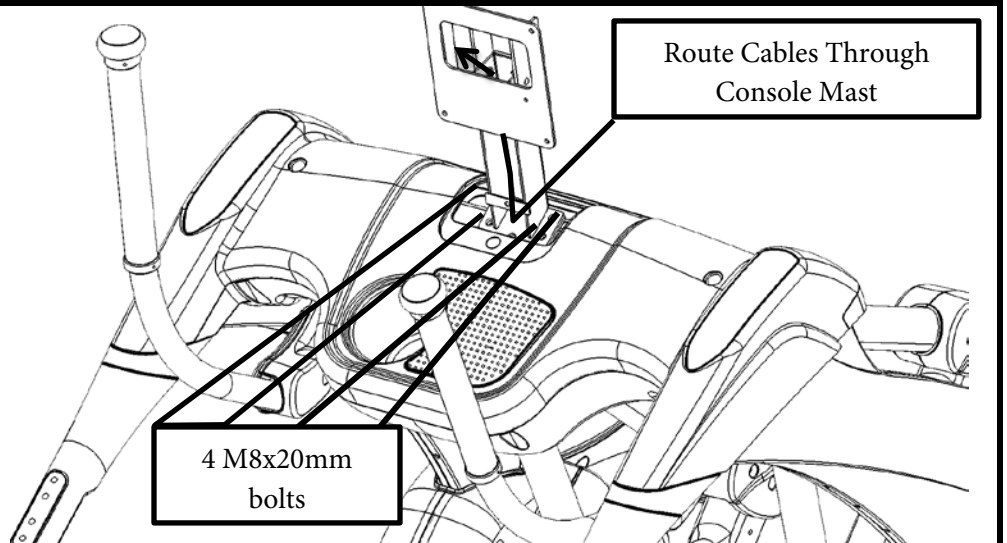

STEP 9: Attach Console:

a) Use 2 M4x16 screws to attach front console cover to mast, being careful to not pinch wires.

Hardware Required (Bag 9):



2 M4x16 Screws

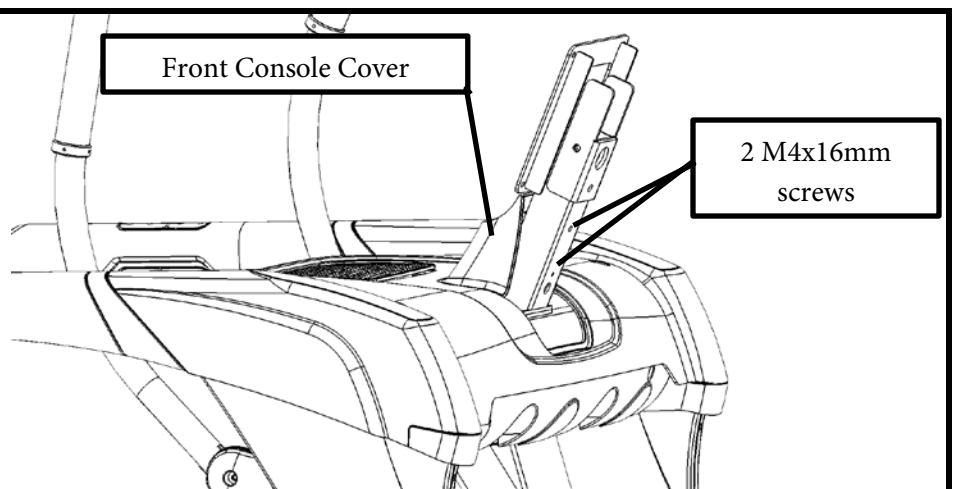

CHAPTER 2: ASSEMBLY INSTRUCTIONS

ELLIPTICAL ASSEMBLY STEPS (CONTINUED):

STEP 9: Attach Console (continued):

b) Attach ground wire coming from the back of the console to the ground screw.

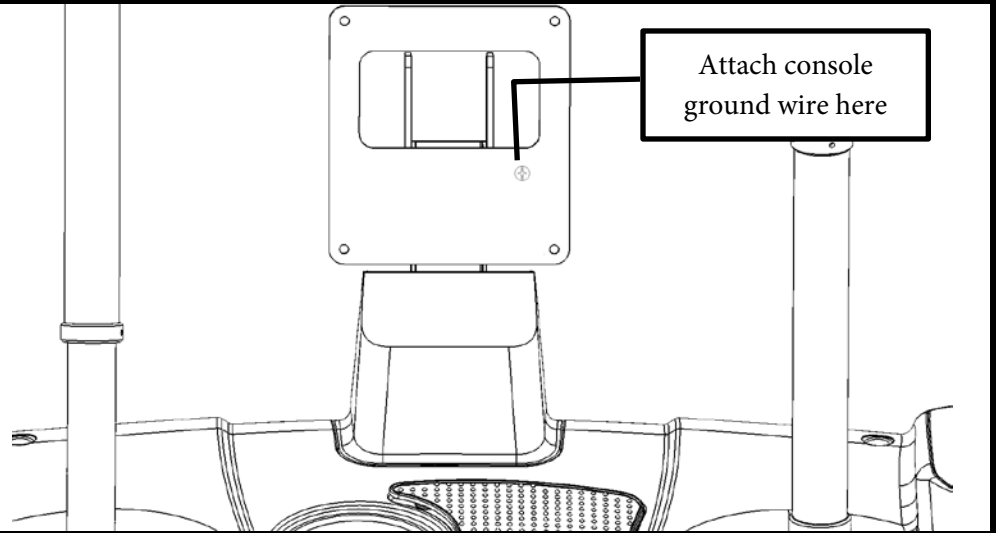

c) Attach console to mast using the 4 M5x12 screws that come with the console.

Required Hardware:
Included with console

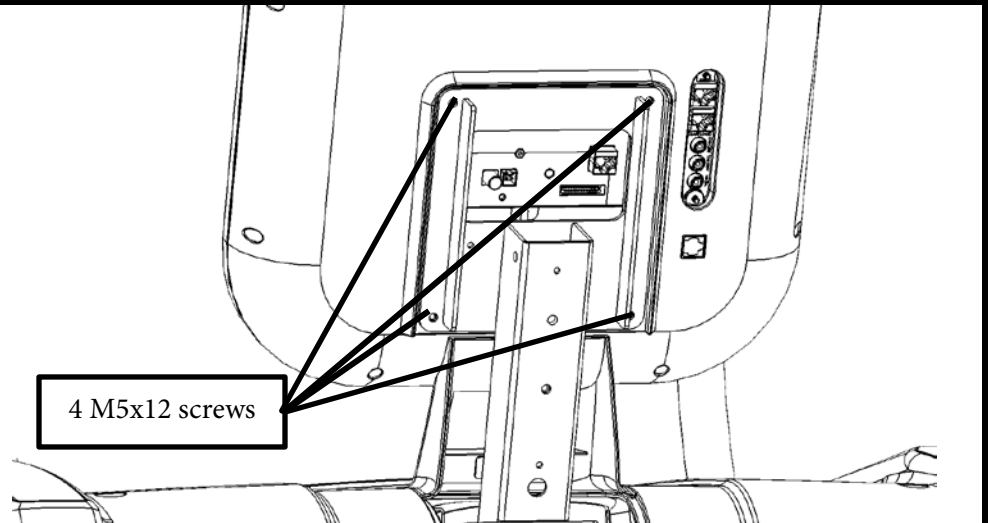

CHAPTER 2: ASSEMBLY INSTRUCTIONS

ELLIPTICAL ASSEMBLY STEPS (CONTINUED):

Step #9A: Attach Console (console):

*Follow Step 9A if installing a touchscreen console or 15" TFT console. For other consoles, proceed to Step 9B.



16" Touchscreen Console



15" TFT Console

Network Cable

Ground Wire

Coaxial Cable

Power Cable 2 Pin



Adapter Cable

Data Cable (USB)

NOTE: Ethernet & Coaxial cable connections are not available on the Orange LED or 9" TFT Consoles
The Ethernet Port on the 15" TFT Console is non-functioning
All Ground Wires Must be connected

CHAPTER 2: ASSEMBLY INSTRUCTIONS

ELLIPTICAL ASSEMBLY STEPS (CONTINUED):

Step #9A: Attach Console (console):

*Follow Step 9A if installing a touchscreen console or 15" TFT console. For other consoles, proceed to Step 9B.

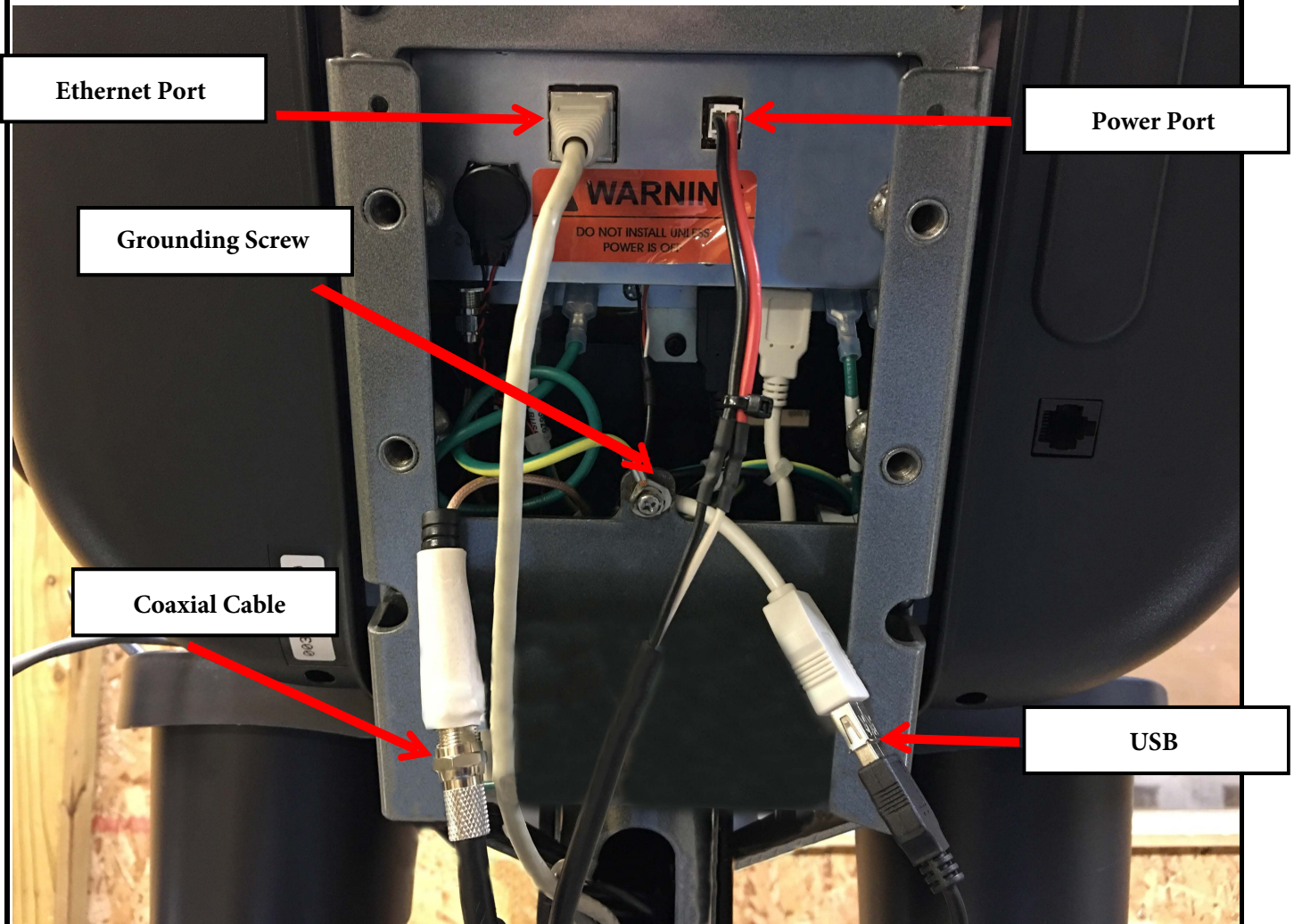

NOTE: Ethernet & Coaxial cable connections are not available on the Orange LED or 9" TFT Consoles
The Ethernet Port on the 15" TFT Console is non-functioning
All Ground Wires Must be connected

CHAPTER 2: ASSEMBLY INSTRUCTIONS

ELLIPTICAL ASSEMBLY STEPS (CONTINUED):

STEP 9B: Attach Console (continued):

9" TFT Console
Orange LED Console



Connect Data Cable (USB)

*Both 9" TFT & Orange LED Consoles

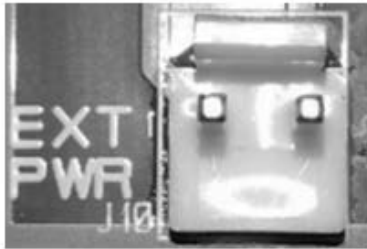

9" TFT Console

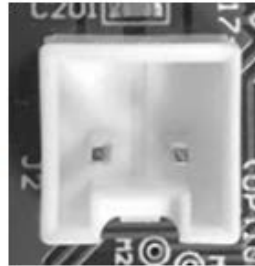

Orange LED Console

Connect Power Cable (2-pin)

Figure 9-3

NOTE: Ethernet & Coaxial cable connections are not available on the Orange LED or 9" TFT Consoles
All Ground Wires Must be connected

d) Attach the Rear Console Cover using 2 M5x12mm screws.

Hardware Required (Bag 9):



2 M5x12 Screws

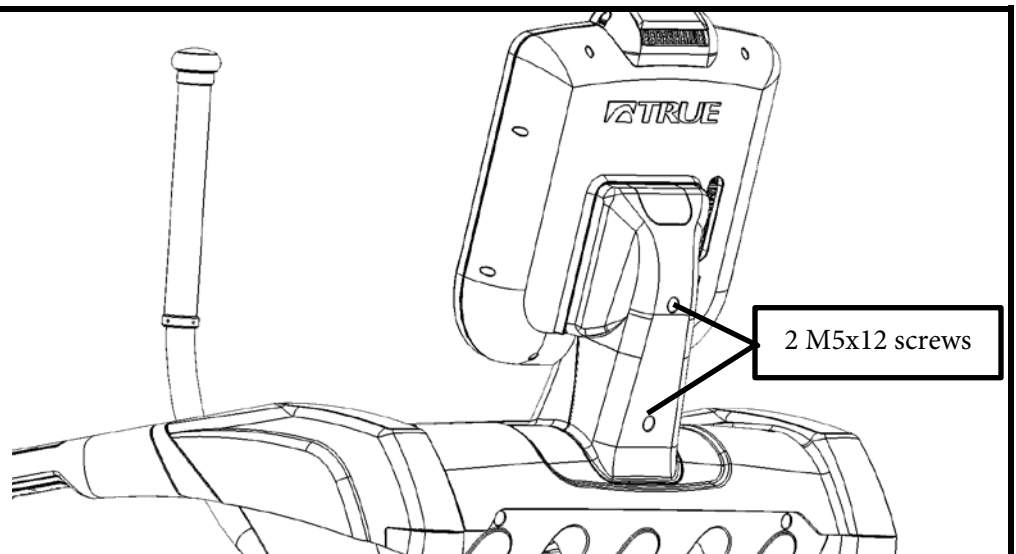

CHAPTER 2: ASSEMBLY INSTRUCTIONS

ELLIPTICAL ASSEMBLY STEPS (CONTINUED):

Step 10: Attach Chin Bar:

a) Attach Chin Bar using 4 M8x12 bolts.

b) Attach Chin bar covers by aligning grooves and sliding forward.

Hardware Required (Bag 10):



4 M8x12mm Bolts

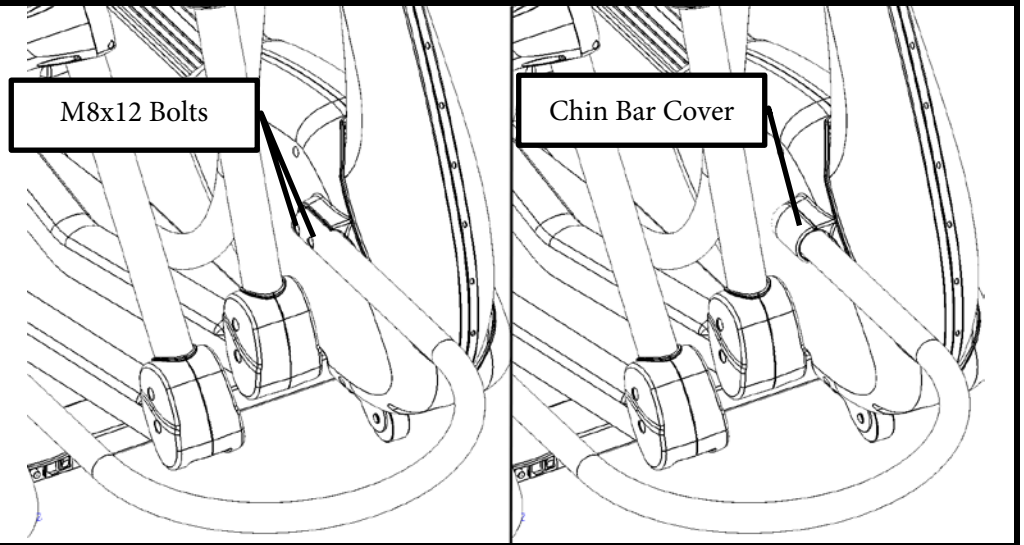

Step 11: Floor Levelers:

If necessary, adjust four levelers on bottom of machine to accommodate uneven flooring.

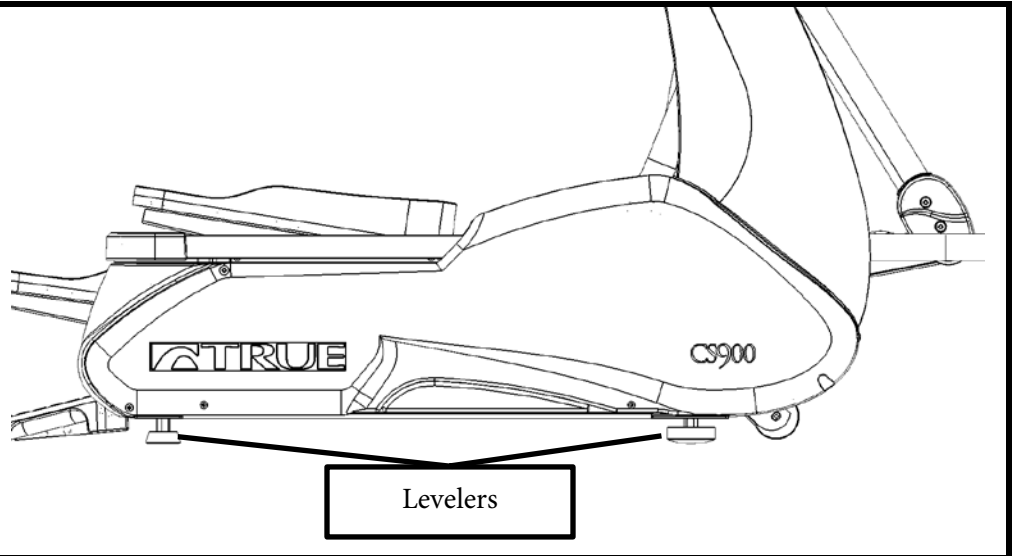

Step 12: Remove Protective Film from Decals:

Once Elliptical is moved into its final location, remove the protective film from the decals and from the "True" on the lower shroud.

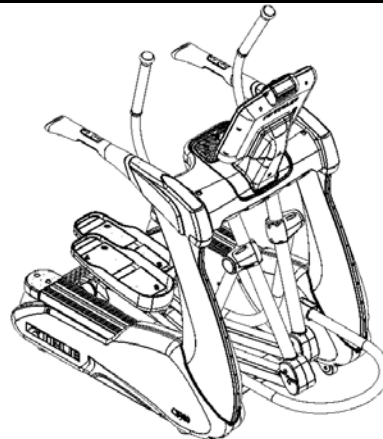

CHAPTER 2: ASSEMBLY INSTRUCTIONS

ELLIPTICAL ASSEMBLY STEPS (CONTINUED):

Optional Power Supply Installation (continued):

*These steps are only required if this unit will be paired with a touchscreen console or 15" TFT Console.

a) Remove both right rear plastic covers.

Note:

The power supply is shipped in the same package as the console

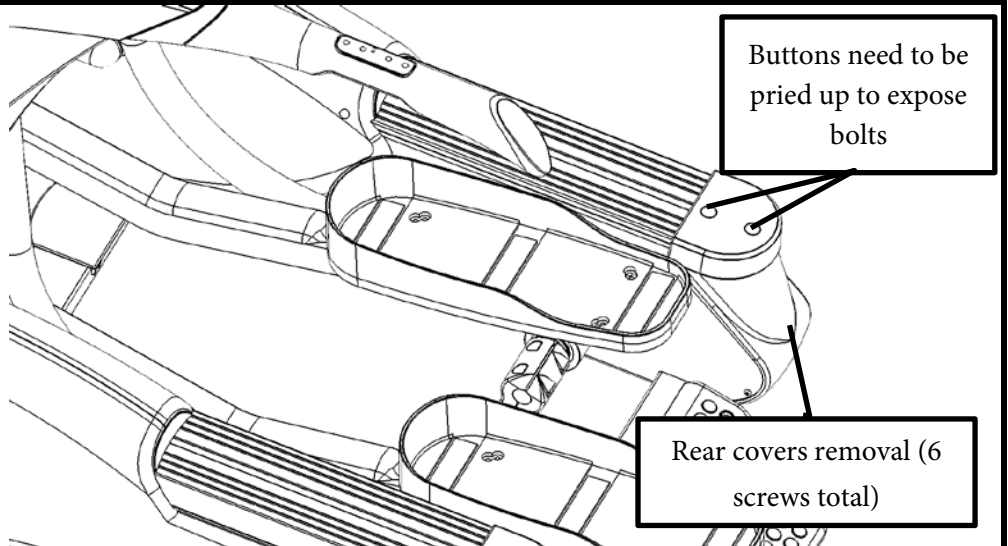

b) Snip zip tie and expose cable bundle.
c) Switch power cable connection from self-generated connection to Power Supply connection as shown.

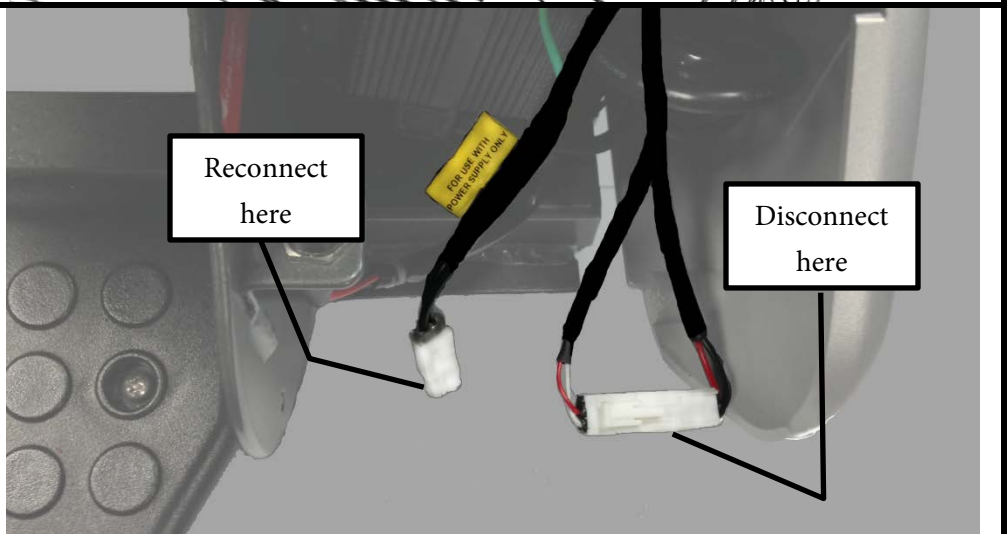

d) Install Power supply connections: Connect 110V input plug and output DC barrel connector.

e) Zip tie Power Supply onto back frame and reinstall back covers making sure that cable will not be pinched.

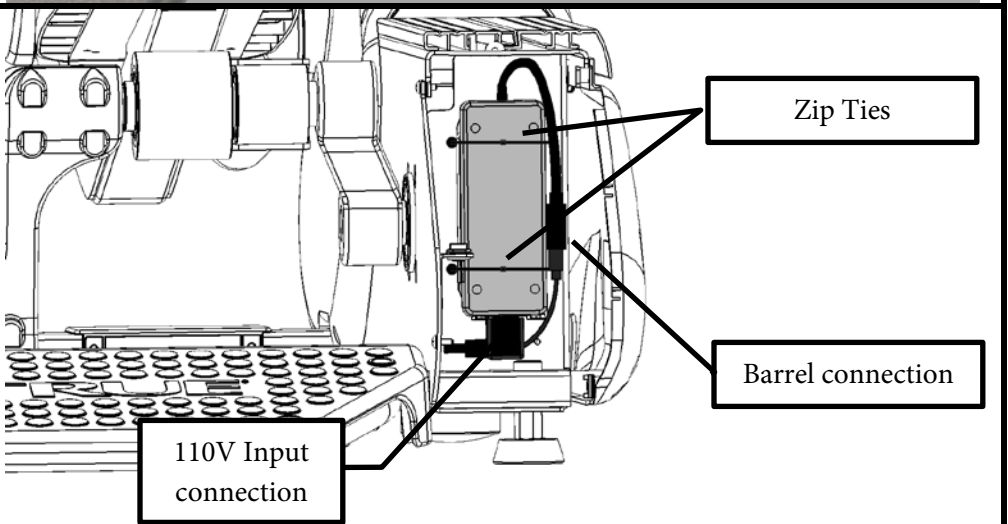

CHAPTER 2: ASSEMBLY INSTRUCTIONS

WIRING DIAGRAMS:

XC900 Wiring Diagram
Self-Generating

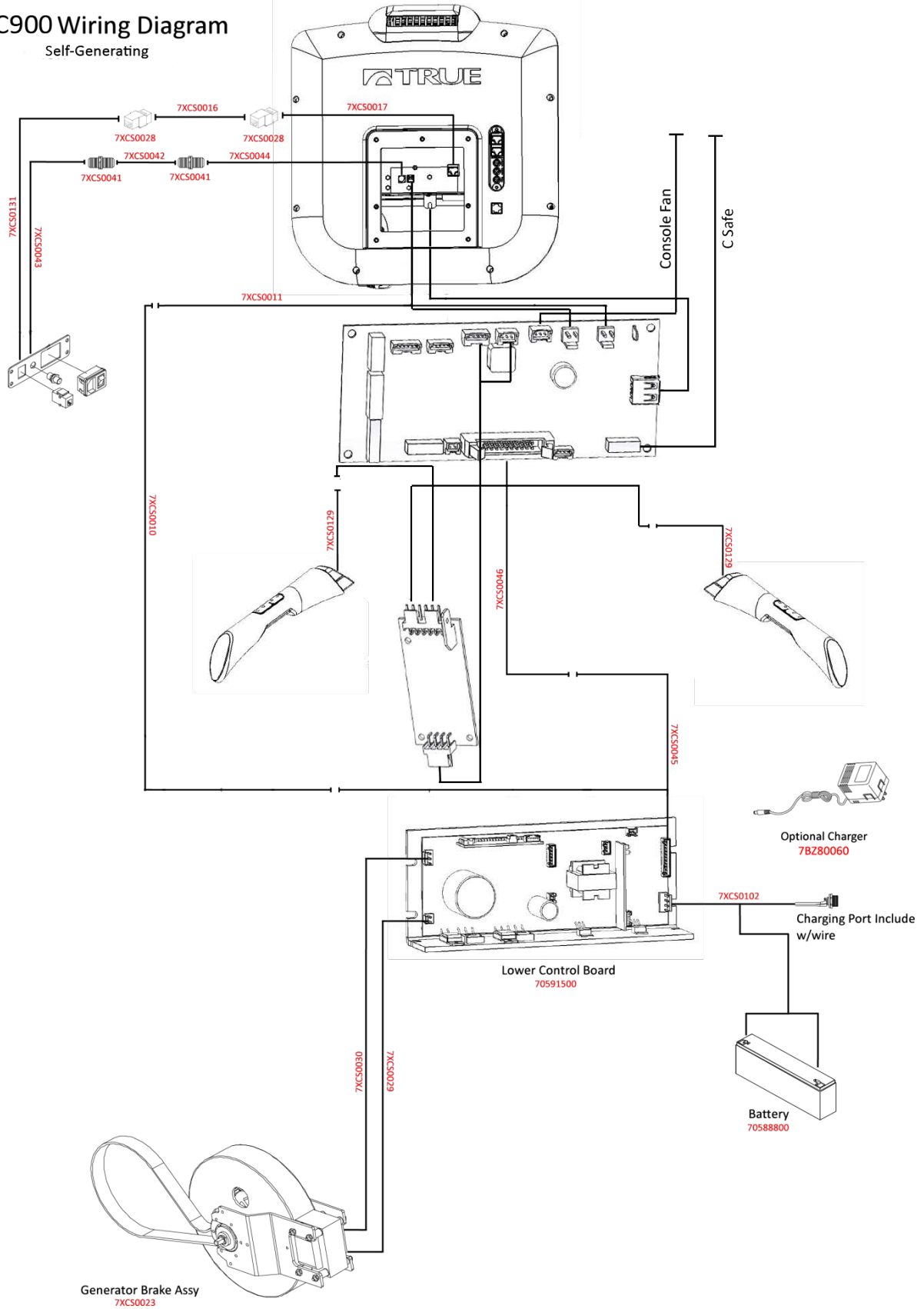

CHAPTER 2: ASSEMBLY INSTRUCTIONS

WIRING DIAGRAMS (CONTINUED):

XC900 Wiring Diagram
w/Optional Power Supply

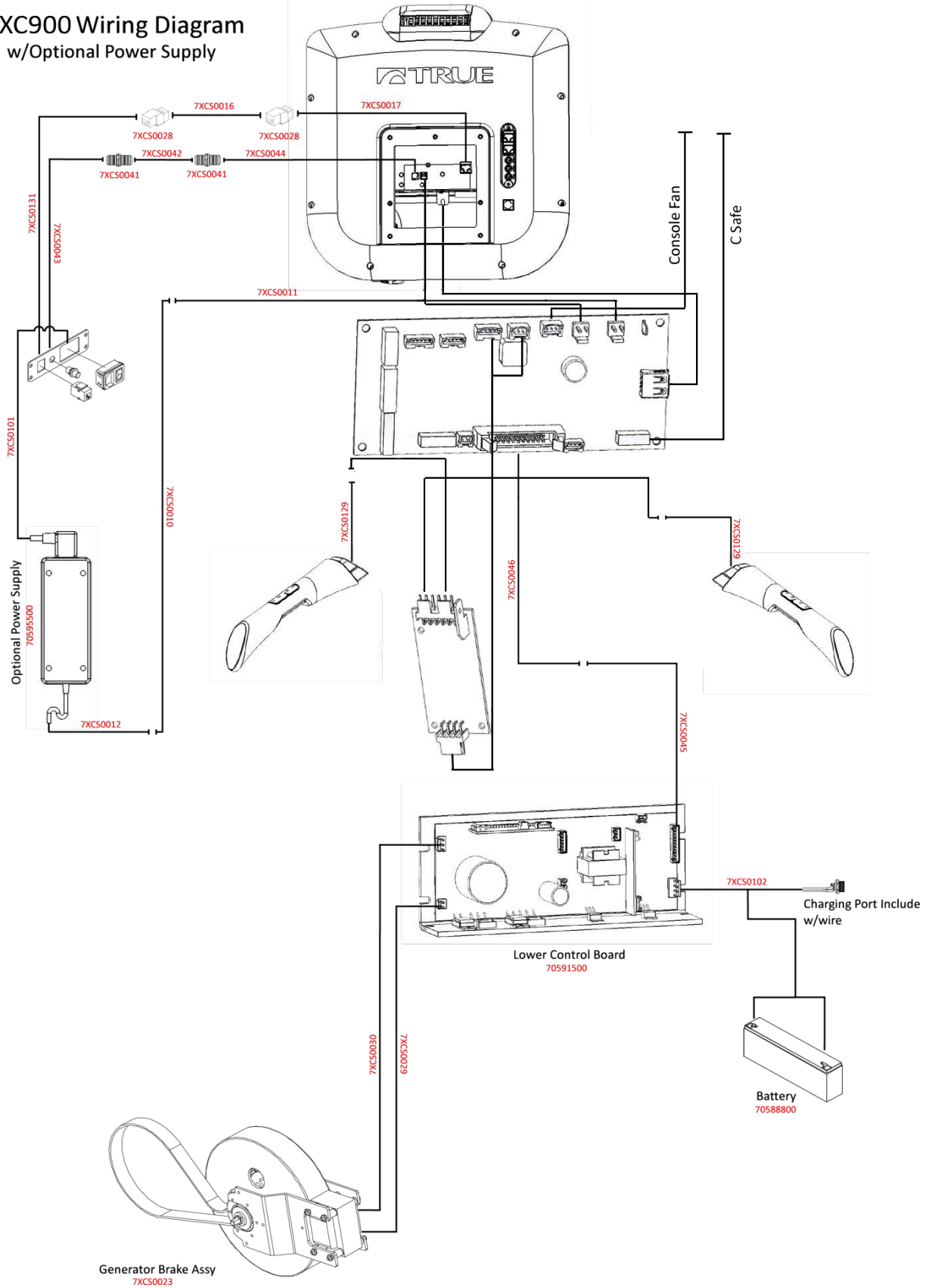

CHAPTER 3: PRODUCT OVERVIEW

ELLIPTICAL OVERVIEW:



CHAPTER 3: PRODUCT OVERVIEW

ELLIPTICAL OVERVIEW (CONTINUED):

Console Assembly:

The console allows the user to set up a workout program and control the elliptical during a workout (For console overview and operation instructions refer to the owner's manual for the selected console option).

Upper Exercise Arms:

Moving handles on the elliptical that provide resistance to the upper body during a workout.

Contact Heart Rate Pads:

Allows the user to check their heart rate without wearing a wireless chest strap.

Side Steps:

The stationary steps on either side of the elliptical, which allow the user to safely straddle the footpads during startup, to isolate upper body, or in the event of an emergency.

Foot Pads:

Moving pedals on the elliptical that provide resistance to the lower body during a workout.

Leveling Feet:

An adjustable system used to aid in the leveling the elliptical.

Coaxial Port:

Delivers television signal to the unit.

Ethernet Port:

Used to provide a network connection for compatible console options.

Power Cord:

Delivers power from the wall outlet to the elliptical.

Battery Charge Port:

A port used to charge the unit's internal battery. To expose the port remove the right rear shroud covers as shown in the figure to the right.

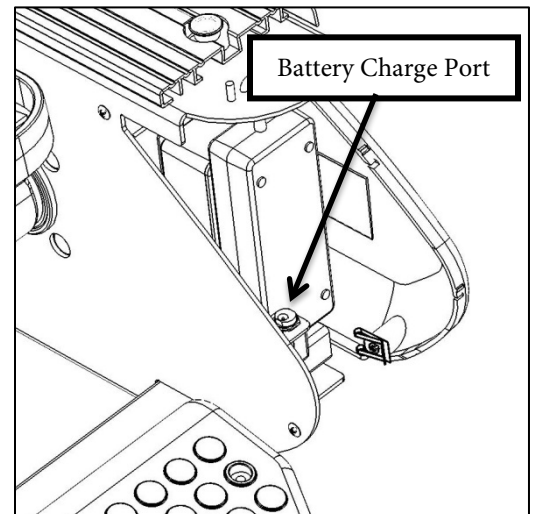

CHAPTER 4: PROGRAMMING & OPERATION

HEART RATE MONITORING:

This elliptical can monitor a user's heart rate using either a Polar® compatible chest strap or the metal grips on the hand rails (called contact heart rate or CHR pads). A chest strap transmits the user's heart rate to the elliptical via radio, and the CHR pads connect to a special computer circuit to extract the user's heart rate.

Chest Strap Heart Rate Monitoring:

Although this elliptical functions fine without using the heart rate monitoring feature, this kind of monitoring gives valuable feedback on the user's effort level. Chest strap monitoring also allows users to use Heart Rate Control, the most advanced exercise control system available. When users wear a Polar® compatible transmitter strap, the elliptical will display the user's heart rate as a digital beats-per-minute (bpm) readout.

The transmitter strap should be worn directly against the user's skin, about 1-2 inches below the pectoral muscles/breast line. Women should be careful to place the transmitter below their bra line.

Initially the transmission signal for heart rate may be erratic or non-existent. Some moisture is necessary between the strap and the user's skin for proper transmission. Sweat from exercise works best, but ordinary tap water may be used prior to the workout if desired.



A Note on Chest Strap Heart Rate Monitoring:

The chest strap produces a radio signal that the elliptical reads and registers as the user's heart rate. The accuracy of a reading may be affected when outside interference is present.

Contact Heart Rate (CHR):

The CHR system will let the user monitor their heart rate without wearing a chest strap. When using the CHR system users should gently grasp the CHR pads with both hands. Within 30 seconds, the user's heart rate should be displayed as a digital bpm readout (during the first 30 seconds the system is analyzing and locking in the user's heart rate). Users should exercise with smooth body motions and breathe regularly. It is best to avoid talking while using the CHR system, as talking will cause unrepresentative heart rate spikes of 5 to 10 bpm. To ensure an accurate reading, the user's hands should be clean, free of both dirt and hand lotions.

A Note on CHR Accuracy:

CHR monitoring may be less accurate than chest strap monitoring since the heart rate signals are much stronger at the chest.

HEART RATE CONTROL (HRC):

Introduction:

You are now the owner of the most sophisticated Heart Rate Control equipment available. TRUE HRC is unique and patented. It accommodates users from rehabilitation to world class athletes, and all those in between. TRUE HRC allows users to do a completely adjustment free heart rate controlled workout. By training at a specific target heart rate, users can exercise at a more efficient cardiovascular level.

CHAPTER 4: PROGRAMMING & OPERATION

HEART RATE CONTROL (CONTINUED):

The TRUE HRC system is unique because users must enter the key parameters of the workout; target heart rate, weight, age, and time, prior to beginning the HRC workout. As users approach their target heart rate, the elliptical's computer takes full control over the workout and changes the workout intensity automatically to keep users near their target heart rate. This allows for a completely "hands free" workout.

Target Heart Rate:

TRUE's heart rate control (HRC) workouts let the elliptical monitor relative exercise intensity by way of the user's heart rate, then automatically adjust the workout intensity to keep the user at their target heart rate and thus their desired exercise intensity. Heart rate is a good measure of the body's exercise stress level. It reflects differences in physical condition, fatigue, the comfort of the workout environment, even diet and emotional state. Users should compare their heart rate with how they feel to ensure safety and comfort.

Consult a physician to determine target heart rate:

Using heart rate to control a workout takes the guesswork out of the workout settings. Consult a physician before using heart rate controlled workouts for advice on selecting a target heart rate range. Also, it is important to use the elliptical for several workouts in the manual mode while monitoring heart rate. Users should compare their heart rate with how they feel to ensure safety and comfort. After users have spent some time learning how their heart responds to different workout intensity levels, they will have a better understanding of how to use the elliptical to reach their target heart rate.

Warm Up:

At the beginning of an HRC workout, the elliptical is in full Manual Control mode. Users should gradually increase the workout intensity to slowly raise their heart rate to within 10 beats per minute (bpm) of their target heart rate. The elliptical will operate as if in manual mode during the warm up stage. Users control the workout intensity. It is important that the user starts at a low level of perceived exertion and gradually increase the workout intensity over several minutes until they approach their target heart rate. This allows the body to adapt to the workout. Increasing the workout intensity gradually will allow the user to enter the heart rate control stage without overshooting their target, keeping their heart rate within a few bpm of their target.

*Warming up too fast may cause the user to overshoot their target. If this occurs it may take several minutes before the computer software can control their heart rate. Users may overshoot and undershoot for several minutes until control is achieved.

Heart Rate Control Stage:

The elliptical takes full control of the workout intensity, keeping the user's heart rate within a few bpm of their target. When using the Interval HRC Workout, the elliptical alternates between work and rest intervals.





Cool-Down:

At the end of the workout time or distance, the elliptical reduces the workout intensity by half and goes back into Manual Control mode, where users directly control their cool-down.

CHAPTER 4: PROGRAMMING & OPERATION

PROGRAM DESCRIPTIONS:

Available programs vary depending on the console option selected. Please refer to the chart below for assistance in determining which programs are available on this unit.

Console Options	 Transcend ¹⁶	 Escalate ¹⁵	 Escalate ⁹	 Emerge
****	YES	YES	YES	YES
***	YES	YES	YES	
**	YES	YES		
*	YES			

Quick Start: ****

A workout in which the user controls all settings. The workout continues until it is ended by the user.

Cardio 360™ Quick Start: ****

Get right into a pre-set 20-minute workout designed to shape and tone every major muscle group.

Manual: ****

Users set up their own workout to a TIME or DISTANCE limit.

Hill Intervals: ****

Hill Intervals are in 2-minute segments with increased WORKLOAD to simulate hills.

Rolling Hills: ****

A series of gradual increasing and decreasing WORKLOAD changes that simulate rolling hills. Users can adjust their LEVEL at any time during the workout to increase or decrease intensity of the hills.

Single Hill: ****

WORKLOAD increases to a maximum at the mid-point of the workout, then decreases to the finish to simulate one big hill.

CHAPTER 4: PROGRAMMING & OPERATION

PROGRAM DESCRIPTIONS (CONTINUED):

Random Hills: ****

A WORKLOAD profile that changes to simulate random hills. Adjust the LEVEL at any time during the workout to increase or decrease the intensity of the hills.

Glute Buster: **

Changing WORKLOAD focuses on intense glute muscle use. For an added challenge, users can reverse the stride motion periodically.

Calorie Goal: ****

This workout allows users to choose the number of calories they wish to burn within a specified workout time. The WORKLOAD will adjust automatically to attain this goal.

Cardio Challenge: **

WORKLOAD and suggested PACE (RPM) increase to a maximum at the mid-point of the workout, then decrease to the finish.

Walk & Run Intervals: **

This workout uses PACE SETTER to suggest walking then running intervals in 1-minute segments. WORKLOAD can be adjusted throughout workout.

Pace Intervals: **

This workout suggests PACE (RPM) intervals in 1-minute segments. The PACE SETTER shows the target pace along with the user's actual pace (RPM) throughout the workout.

Pace Ramp: **

This workout suggests PACE (RPM) increases to a maximum at the mid-point of the workout, then decreases to the finish. The PACE SETTER shows the user's target pace throughout the workout.

Leg Shaper: **

A workout that suggests PACE changes to work the leg muscles with added intensity. Reverse stride occasionally for an added challenge.

Distance Workouts:

Choose any one of our 4 common distance workouts - 5k****, 10k****, 2 mile** or 4 mile**.

Saved Workouts: **

Access to previously saved workouts.

CHAPTER 4: PROGRAMMING & OPERATION

PROGRAM DESCRIPTIONS (CONTINUED):

Custom Pace: **

Easy to change setup screens allow users to customize any PACE SETTER (RPM) profile to add variation to their cardio session.

Custom Hill: **

Easy to change WORKLOAD interval workouts that simulate hills. User friendly setup screens allow users to create any hill profile.

Custom Ultra: **

If users are having trouble finding a workout that fits their specific needs, try setting up the Custom Ultra! This completely customizable workout setup allows WORKLOAD and PACE SETTER interval control as well as the ability to control interval time.

HRC Cruise Control: ****

While in any program, Cruise Control will allow the user to set current heart rate as target heart rate by pressing a single button. The Cruise Control program takes control of WORKLOAD to maintain the users target Heart Rate. If Beats Per Minute exceeds the target by more than 12 BPM the workout will end and Cool Down will begin.

HRC Target: ****

Users choose their target heart rate. The workout begins in MANUAL control - gradually increase WORKLOAD until heart rate is within 10 bpm of their target. At this point, the machine takes control of WORKLOAD to maintain the user's heart rate within a few beats of their target.

HRC Weight Loss: ***

Based on age, this is a heart rate controlled workout at 65% of the user's maximum heart rate. This creates efficient fat burning without overtraining. The workout begins in MANUAL control - gradually increase WORKLOAD until heart rate is within 10 bpm of the user's target. At this point the machine takes control of WORKLOAD to maintain the user's heart rate within a few beats of their target.

HRC Aerobic: ***

Based on age, this is a heart rate controlled workout at 80% of the user's maximum heart rate. This keeps them in the optimum aerobic training range to improve cardio fitness. The workout begins in MANUAL control – users should gradually increase WORKLOAD until their heart rate is within 10 bpm of their target. At this point the machine takes control of WORKLOAD to maintain the user's heart rate within a few beats of their target.

HRC Intervals: ***

Intervals of WORK and REST determined by target heart rate. The workout begins in MANUAL control –users should gradually increase WORKLOAD until their heart rate is within 10 bpm of their target. At this point, the machine takes control of WORKLOAD to maintain the user's heart rate within a few beats of their target. The rest segment will reduce to 65% intensity of work segment.

CHAPTER 4: PROGRAMMING & OPERATION

PROGRAM DESCRIPTIONS (CONTINUED):

Custom HRC Intervals: **

Users can set up their own heart rate intervals. Specify WORK and REST targets and let the machine make all the adjustments. The workout begins in MANUAL control - gradually increase WORKLOAD until heart rate is within 10 bpm of the user's target. At this point the machine takes control of WORKLOAD to maintain the user's heart rate within a few beats of their target.

HRC Distance Workouts: **

4 popular fixed distance workouts that put the machine in control of maintaining target heart rate. Choose between a 5K, 10K, 2 mile or 4 mile workout. The workout begins in MANUAL control - gradually increase WORKLOAD until heart rate is within 10 bpm of the user's target. At this point the machine takes control of WORKLOAD to maintain the user's heart rate within a few beats of their target.

Fitness Test: ***

A fitness test used to estimate the user's VO2 max.

Cardio 360™: ****

If users are looking for variety to make their cardio workout fly, try this random cycle of Cardio360 exercises for a great total-body workout.

Cardio 360™ Arm Sculptor: ****

Users challenge their upper body and core to this 10-minute, 3-motion program, following along at their own intensity.

Cardio 360™ Leg Shaper: ****

Tightens and tones user's legs and glutes, and allows changing resistance on the fly.

Cardio 360™ Custom: ***

Users can modify and maximize their workout to its fullest potential. Cardio360 Custom lets users build a personalized routine, choosing their favorite Cardio360™ motions and lengths of time. Then save their set-up for next time.

CHAPTER 4: PROGRAMMING & OPERATION

VIRTUAL ACTIVE VIDEOS: *

*Content is provided by Virtual Active™ and is subject to change without notice.

Indoor Cycling Group World Tour Northern Italy:

Northern Italy is a cyclist's dream, where stunning views meet tough terrain. The rugged cliffs along Italy's largest lake, Lago di Garda are just a short ride away from the idyllic small town of Pregasina, and the rural mountain passes of Gampenjoch are as beautiful as they are treacherous. Enjoy one advanced hill climb, and one endurance-focused ride with mixed terrain.

Destinations Include:

- Sentiero Ponale, Lago di Garda, Veneto
- Pregasina, Lago di Garda, Veneto
- Località Viote, Lago di Garda, Trento
- Ötztal Alps, Bolzano-Bozen
- Penser Joch, Bolzano, South Tyrol
- Gampenjoch, Bolzano, South Tyrol



Chicago Run:

Explore the tall buildings and wide public parks of this Midwestern metropolis. From the sculpture gardens of Millennium Park, to the shores of Lake Michigan, to the shops that line the Magnificent Mile, the Windy City boasts spectacular sights. The guided workout is speed-focused, and includes two challenging sprints.

Destinations Include:

- Grant Park
- The Magnificent Mile
- Lake Michigan
- Chicago River Walk



Germany Run:

Run the Rhineland, from the thick forests of Thuringia to the Gothic spires of Nuremburg. This lively mix of urban and natural courses includes a jaunt past the waterfalls that decorate the Wimbachklamm gorge and a visit to Munich's bustling plaza, Marienplatz, in the heart of Bavaria. The guided workout alternates speed challenges and recovery intervals.

Destinations Include:

- Thuringian Forest, Thuringia
- Berchtesgaden National Park, Bavaria
- Berchtesgadener Land, Bavaria
- Munich, Bavaria
- Nuremburg, Bavaria



CHAPTER 4: PROGRAMMING & OPERATION

VIRTUAL ACTIVE VIDEOS (CONTINUED):

American Southwest 2 Run:

Return to the crimson cliffs of the Southwest. Scale Angel's Landing in Zion National Park in Utah, surf "The Wave" in Arizona, and go all-in, with a sprint down the fabulous Las Vegas Strip in Nevada. The guided workout begins with a quick build and maintains a strong pace throughout.

Destinations Include:

- Zion National Park, Utah
- Vermilion Cliffs National Monument, Utah
- Vermilion Cliffs National Monument, Arizona
- Las Vegas, Nevada



Wild California Run:

Explore California's Sierra Nevada mountain range, home to the awe-inspiring domes and waterfalls of Yosemite National Park, and General Sherman, the world's largest tree. The guided workout starts with a challenging climb to the top of Morro Rock, before relaxing into a moderately difficult finish.

Destinations Include:

- Sequoia National Park, California
- Yosemite National Park, California
- Sequoia National Forest, California



Trinity Mountains Hike:

The northwestern corner of California is home to the Shasta-Trinity Mountains, a rugged region of remote beaches, and thunderous herds of Roosevelt elk. Marvel at the magnificent giant sequoias on the Boy Scout Tree Trail and climb to the eerie edge of Devil's Punch Bowl. The guided workout is front-loaded with climbs and back-loaded with speed.

Destinations Include:

- Siskiyou Wilderness
- Jedidiah Smith Redwoods State Park
- Castle Crags State Park
- Prairie Creek Redwoods State Park
- Prairie Creek Redwoods State Park
- Shasta-Trinity National Forest

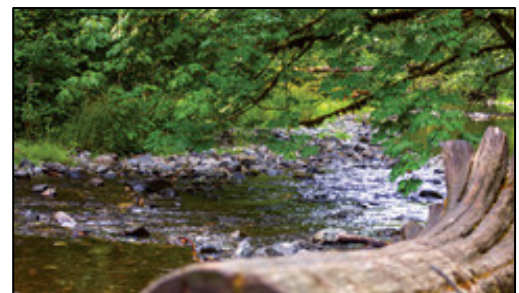

CHAPTER 4A: TRANSCEND OPERATION

TRANSCEND OVERVIEW:



CHAPTER 4A: TRANSCEND OPERATION

TRANSCEND OVERVIEW (CONTINUED):

Touchscreen Display:

A capacitive touchscreen used for workout control and feature navigation.

Headphone Jack:

Standard 3.5mm audio jack used to connect headphones to the console during media playback.

USB Jack:

Allows users to export workout data to an external USB drive or update the console software.

Auxiliary LCD Display:

Displays workout data that can be easily viewed regardless of which mode is displayed on the Touchscreen Display. *Available on the 16" model only.

Reading Rack:

This ledge on the console can be used to hold a book, magazine, e-reader, or tablet computer during a workout.

Cooling Fan:

Integrated fan that delivers a cooling flow of air during a workout.

Warning Decal:

Important safety information for users to review prior to using the equipment.

CHAPTER 4A: TRANSCEND OPERATION

TOUCHSCREEN INTRODUCTION:

The Transcend Console utilizes a fully integrated capacitive touch screen display and a multi-screen interface to provide a state of the art and user friendly workout.









Capacitive touchscreen technology relies on the conductive properties of the human body to detect when and where on a display the user is touching. Because of this, capacitive touchscreens are highly responsive and can be activated with very light touches of the user's finger.

TOUCHSCREEN NAVIGATION:

TRUE recommends that users familiarize themselves with the different screens to ensure that they are safely taking advantage of all of the features that this equipment has to offer.

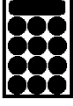
Icon Character Map:

This console uses several icons to provide users with a simplified and visually appealing workout experience. The character map below is a quick reference of commonly used icons.

	Workload		Pace
	Cool Down		Toolbox
	Fan Icon		Keypad
	Screen Toggle		Home
	TV		Virtual Active®

CHAPTER 4A: TRANSCEND OPERATION

TOUCHSCREEN NAVIGATION (CONTINUED):

Home Screen:

The Home Screen is displayed on the console when there is no workout in progress. From this screen the user is able to select from various options to begin a workout or view media.

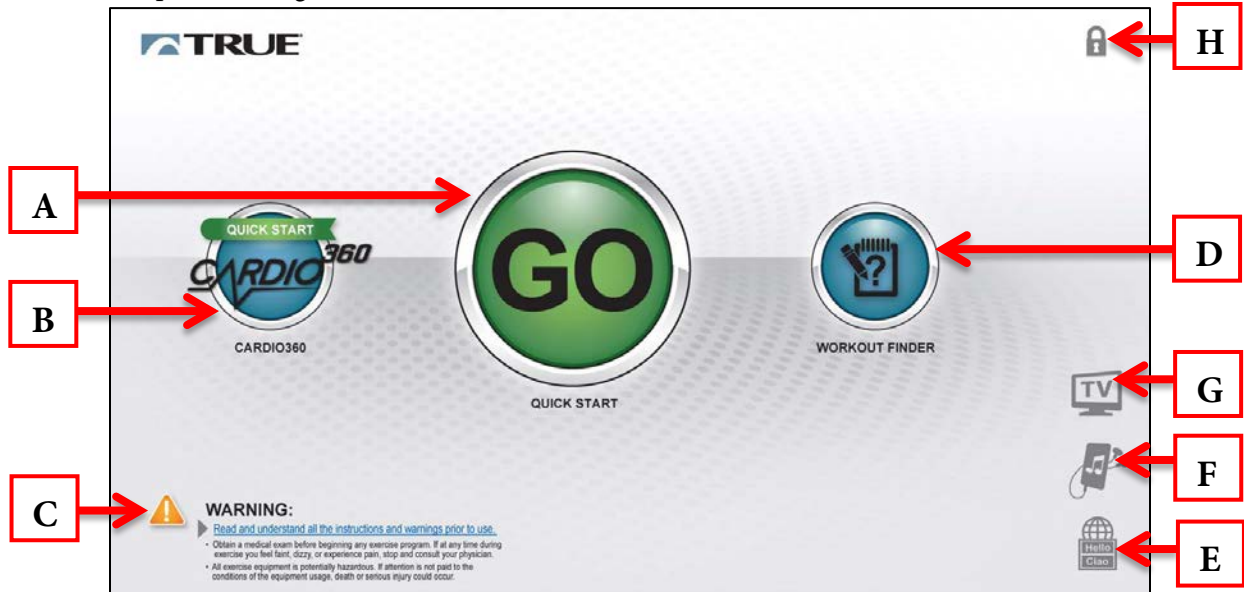

A) Quick Start:

Starts a Quick Start workout in which the user controls all settings. The workout continues until it is ended by the user.

B) Quick Start Cardio 360™:

Starts a 20 minute Cardio 360™ workout in which the user controls the workout intensity.

C) Safety Instructions:

Displays a list of safety instructions for users to review prior to beginning a workout.

D) Workout Finder:

Displays preset workouts categorized by goal focus categories.

E) Language Options:

Allows users to choose between 12 language options.

F) iPod®:

Displays the iPod interface without starting a workout.

G) TV:

Displays TV interface without starting a workout.

H) Screen Lock:

When the screen lock is held for 3 seconds, the touchscreen display will lock for 20 seconds to allow for cleaning.

CHAPTER 4A: TRANSCEND OPERATION

TOUCHSCREEN NAVIGATION (CONTINUED):

Selecting a Preset Workout:

Preset workouts are accessed by touching the Workout Finder Button on the home screen. Workouts are organized into 5 categories. To view the workouts in a category simply touch a Category Selection button (A) or swipe through categories in the category preview window (B). Workouts can also be viewed in an uncategorized list by touching Show All Workouts button (C).

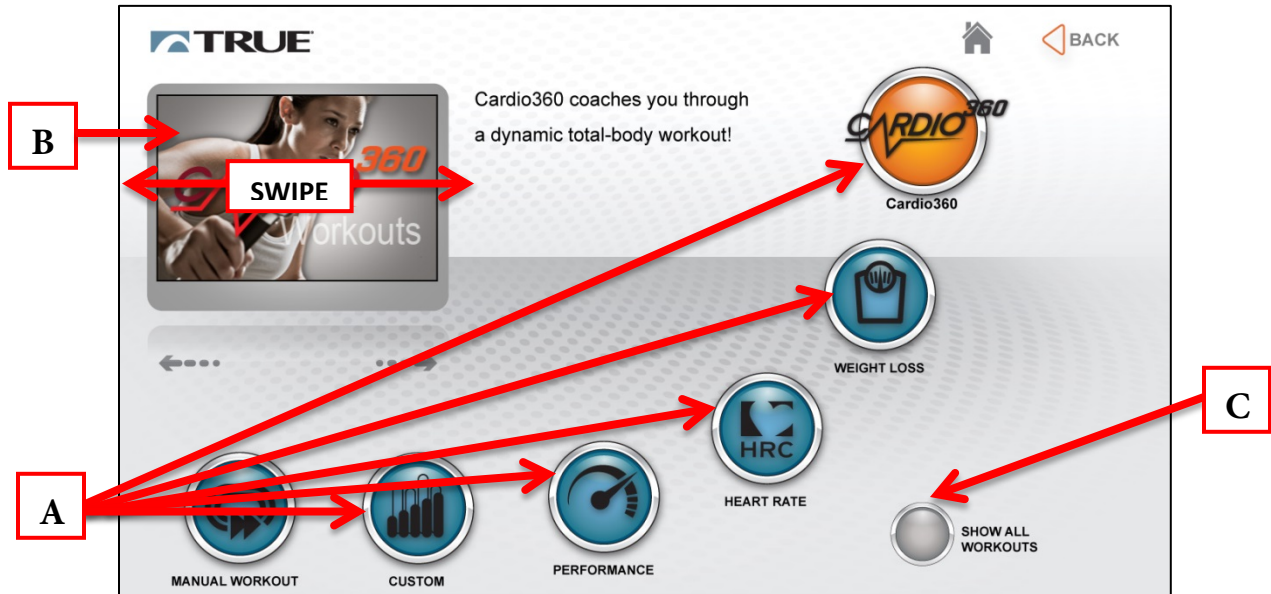

Workout Data Entry Screens:

Workout data entry screens allow the user to input their personal information or workout goals prior to beginning a preset workout. To set a value, touch the heading (A) of the value and adjust the slider (B) to the desired setting or manually enter a value using the keypad (C).

*Workout Data Entry Screens vary by program selection.

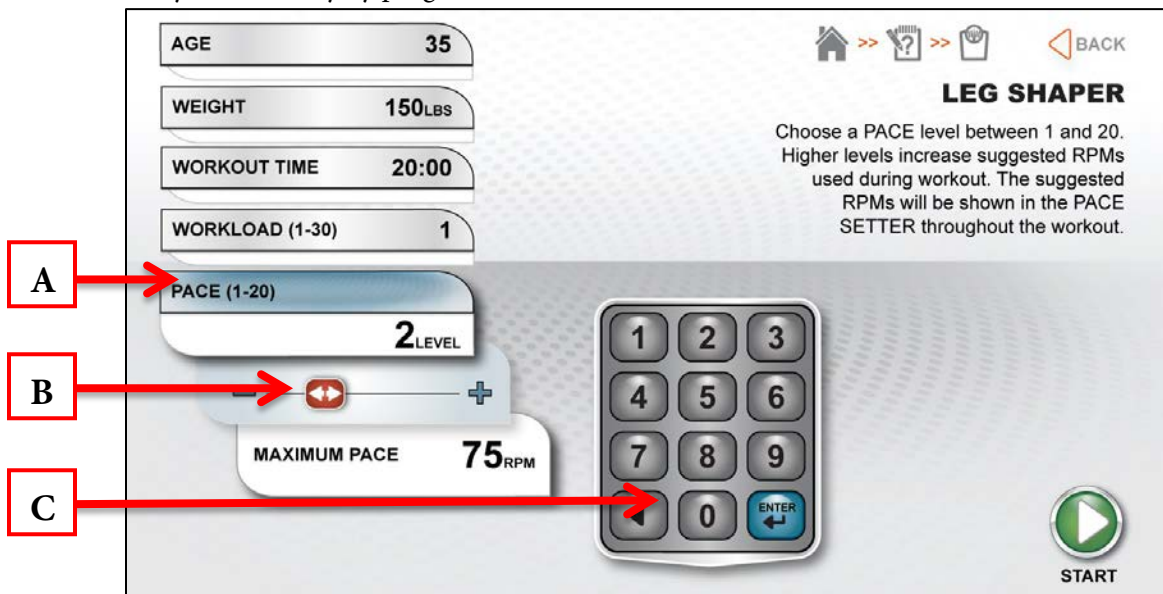

CHAPTER 4A: TRANSCEND OPERATION

TOUCHSCREEN NAVIGATION (CONTINUED):

Workout Data Screens:

During any workout a Workout Data Screen will be displayed to give the user a comprehensive visual overview of their current workout data.

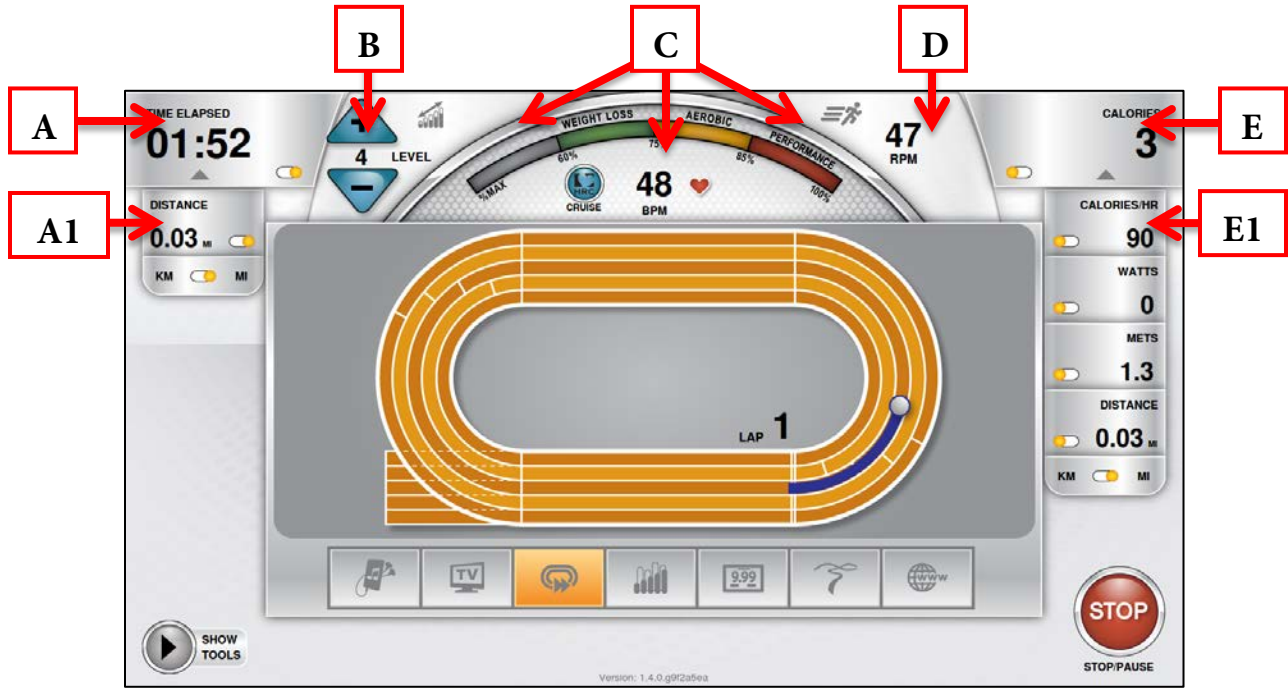

A) Custom Data Display #1:

This display will toggle between multiple data points. To select which data points are displayed press the arrow below the Data Display to open the Selection Toolbox (A1).

B) Workload Level:

Displays the current Workload level.

C) Heart Rate Information:

When the user is wearing a heart rate chest strap or utilizing the contact heart rate system, their heart rate will be displayed in beats per minute (bpm) and in the graphic meter. The graphic meter is based on age and will gauge the user's approximate heart rate within 3 target levels; Weight Loss, Aerobic or Performance.

D) Pace/RPM:

Displays the current pace of a workout.

E) Custom Data Display #2:

This display will toggle between multiple data points. To select which data points are displayed press the arrow below the Data Display to open the Selection Toolbox (E1).

CHAPTER 4A: TRANSCEND OPERATION

TOUCHSCREEN NAVIGATION (CONTINUED):

Workout Data Screen Controls:

The Workout Data Screens contain controls that allow users to adjust settings during their workout

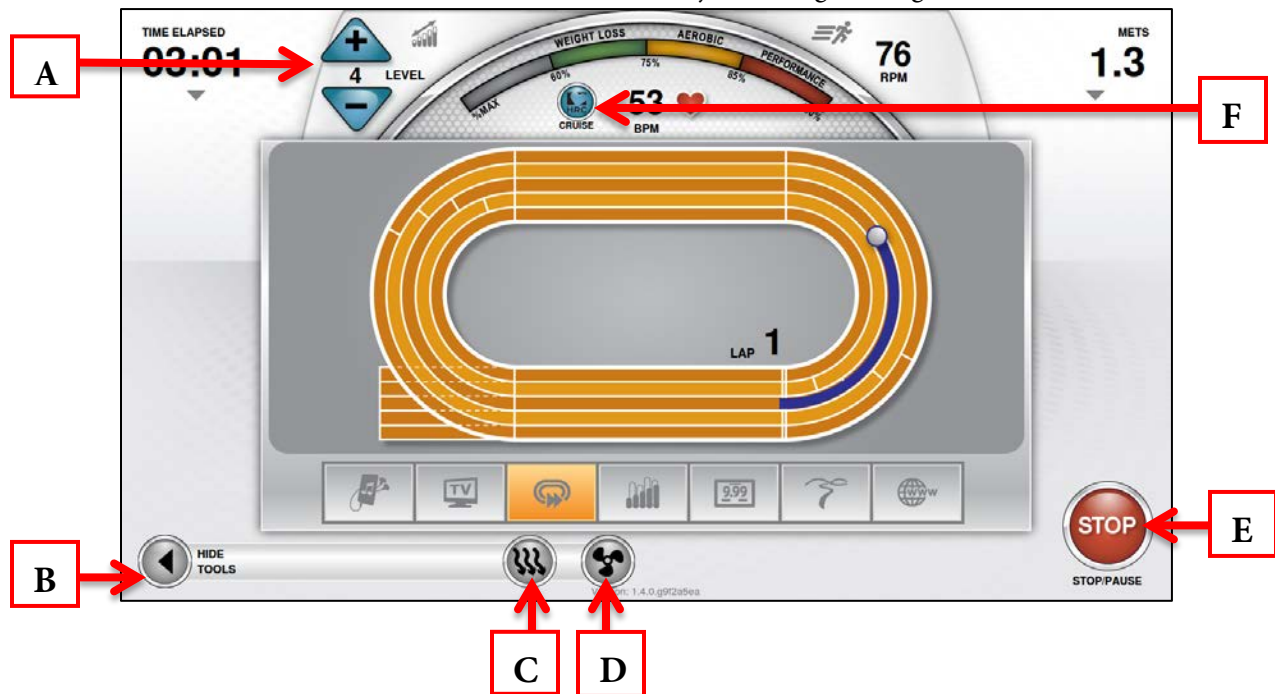

A) Workload Control:

Allows the user to manually increase or decrease the workload during a workout.

B) Show/Hide Tools:

Opens or closes the onscreen toolbox.

C) Cool Down:

This button is displayed by touching the Show/Hide Tools button (B) and allows the user to end their current workout with a two minute low intensity cool down period. When Cool Down is activated the unit is in manual mode and the user directly controls all settings.

D) Fan On/Off:

This button is displayed by touching the Show/Hide Tools button (B) and turns the cooling fan on or off.

E) Stop:

Stops or pauses the current workout.

F) HRC Cruise Control:

Engages Heart Rate Control to allow the equipment to maintain the user's current heart rate through automatic adjustments to the workout intensity (when the user is utilizing heart rate monitoring).

CHAPTER 4A: TRANSCEND OPERATION

TOUCHSCREEN NAVIGATION (CONTINUED):

Switching Between Workout Data Screens:

There are several Workout Data Screens available to choose from. To switch between screens the user can touch the button selector (A) for the specific Workout Data Screen they wish to view or simply swipe their finger across the main display window (B) to scroll through the available screens.

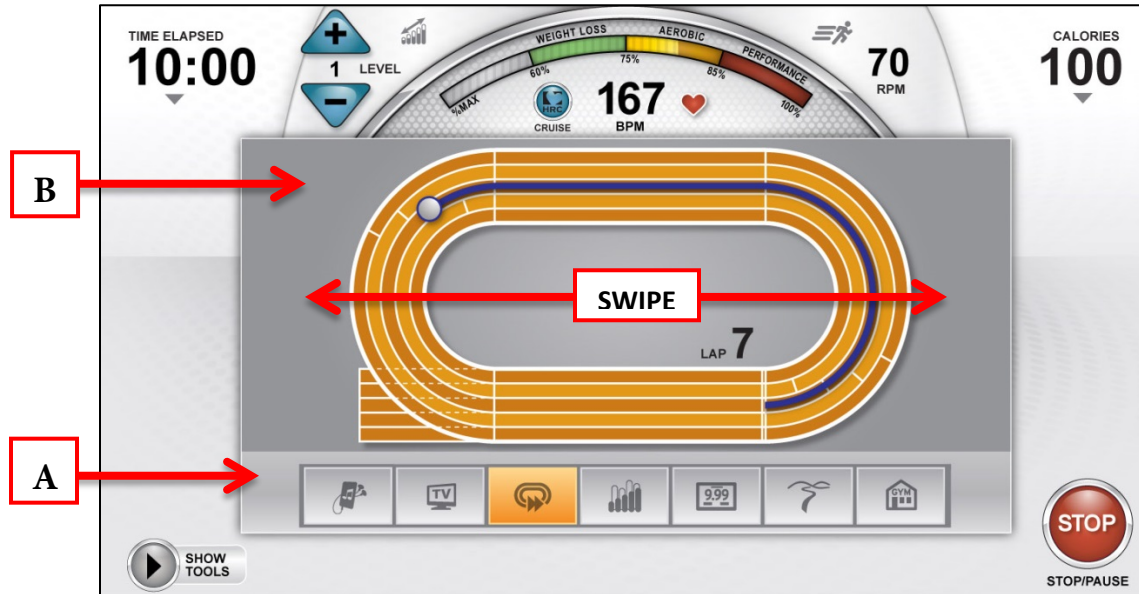

Workout Summary Screen:

At the end of a workout the Summary Screen will display an overview of the workout data. The workout data can be exported to another device by inserting a USB drive into the console's USB port and touching the Save button (A). If the user requires more time to view the summary or to save the workout to a USB device, they can touch the timer (B) to extend the time that the summary remains on the screen. .



CHAPTER 4A: TRANSCEND OPERATION

TOUCHSCREEN NAVIGATION (CONTINUED):

Cardio 360™:

TRUE's unique Cardio 360™ is like having a personal trainer built in to the elliptical, walking users through a full-body workout. In just minutes, users will work their upper-body, lower-body and core. Plus, with the variety that Cardio 360™ brings, it will take the bore out of working out. The program walks users through the various movements they need to do to achieve the complete workout, so all they need to do is commit to stepping on the machine.

During a Cardio 360™ program the Cardio 360™ Workout Data Screen will be displayed to guide users through the program.

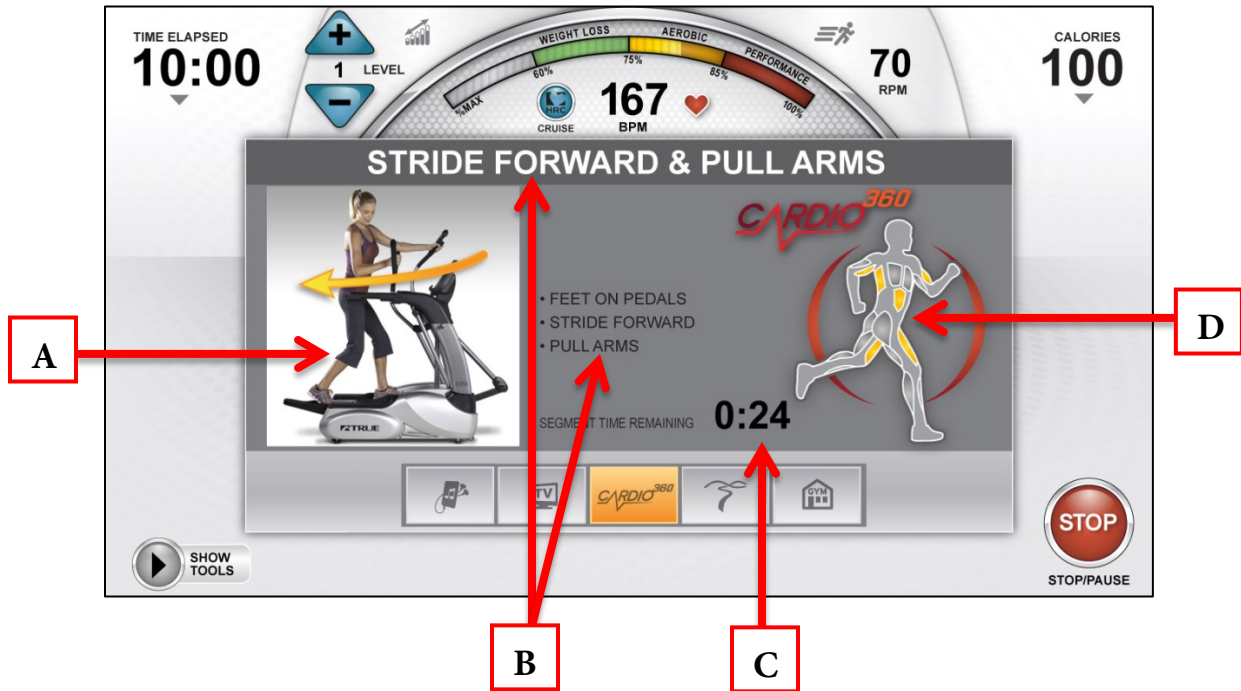

A) Example Window:

Gives users a visual example of the current workout segment.

B) Workout Directions:

Tells the user what actions to take during a workout segment.

C) Segment Time Remaining:

Displays the time remaining in the current workout segment.

D) Target Display:

Highlights the muscle groups being targeted during the current workout segment.

CHAPTER 4A: TRANSCEND OPERATION

WEB BROWSER:

When enabled, the integrated web browser allows users to catch up on breaking news, watch sports highlights, check email and connect with their friends on social media. Having this feature built into a Workout Data Screen allows users to easily multi task.

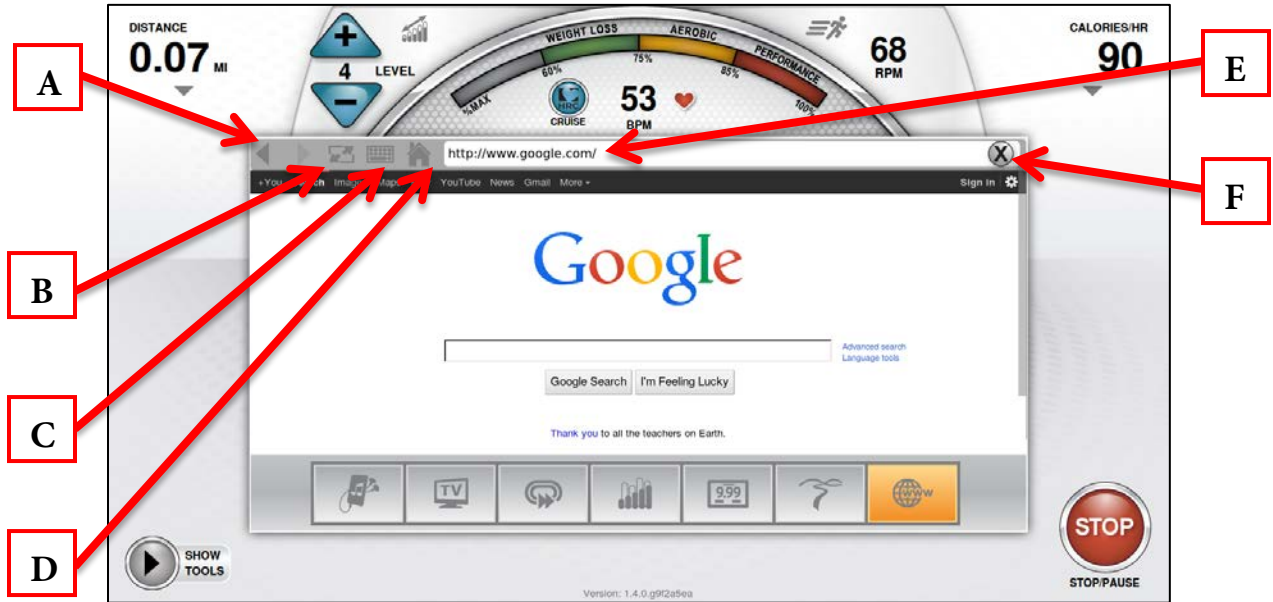

A) Navigation Buttons:

Move forward or backward to the previous page displayed

B) Screen Toggle:

Allows the user to switch back and forth between full screen and regular mode.

C) Keyboard:

Displays the onscreen keyboard to allow users to input text.

D) Home:

Displays the browsers home page.

*See advanced console options for instructions on setting the homepage.

E) Address Bar:

Displays the web address of the page that is being displayed and allows users to input the addresses of pages they wish to visit.

F) Clear Address:

Clears the web address of the page currently being displayed to allow users to input the address of the page they wish to visit.

CHAPTER 4A: TRANSCEND OPERATION

BLUETOOTH AUDIO:

This console has integrated Bluetooth support for Bluetooth enabled audio devices. To pair a device with the console, touch the iPod®/Audio Device Selection Button (A). Ensure that the device is discoverable via Bluetooth and press the Bluetooth Button (B) to search for devices.



The console will complete a scan for available Bluetooth devices. Once the scan is complete, simply touch the name of the desired device (C) to begin the pairing process.

*If the device is not listed, verify that it the Bluetooth is enabled and that the device is discoverable. Then touch the Bluetooth logo (D) to re-scan for the Bluetooth devices.

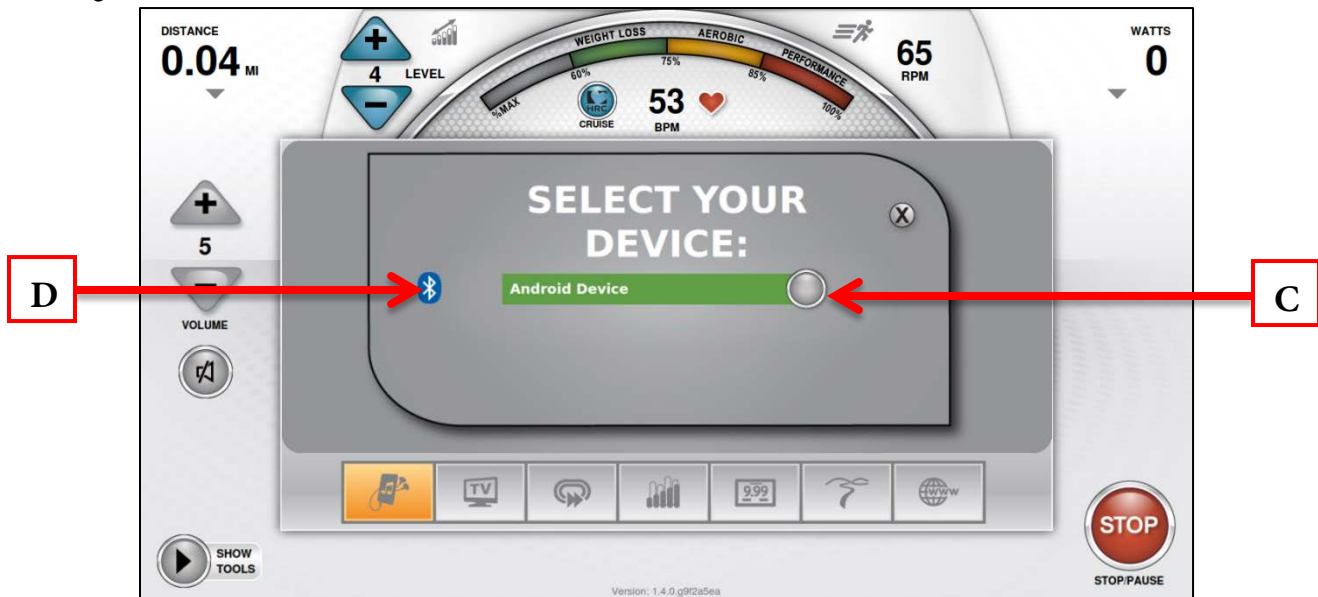

CHAPTER 4A: TRANSCEND OPERATION

BLUETOOTH AUDIO (CONTINUED):

When a device is selected from the list, the console will send a pairing request to that device. The pairing request must be accepted in order for this feature to operate. For iOS devices, press Pair (E) to accept the request. For Android devices, press Accept (F) to accept the request.

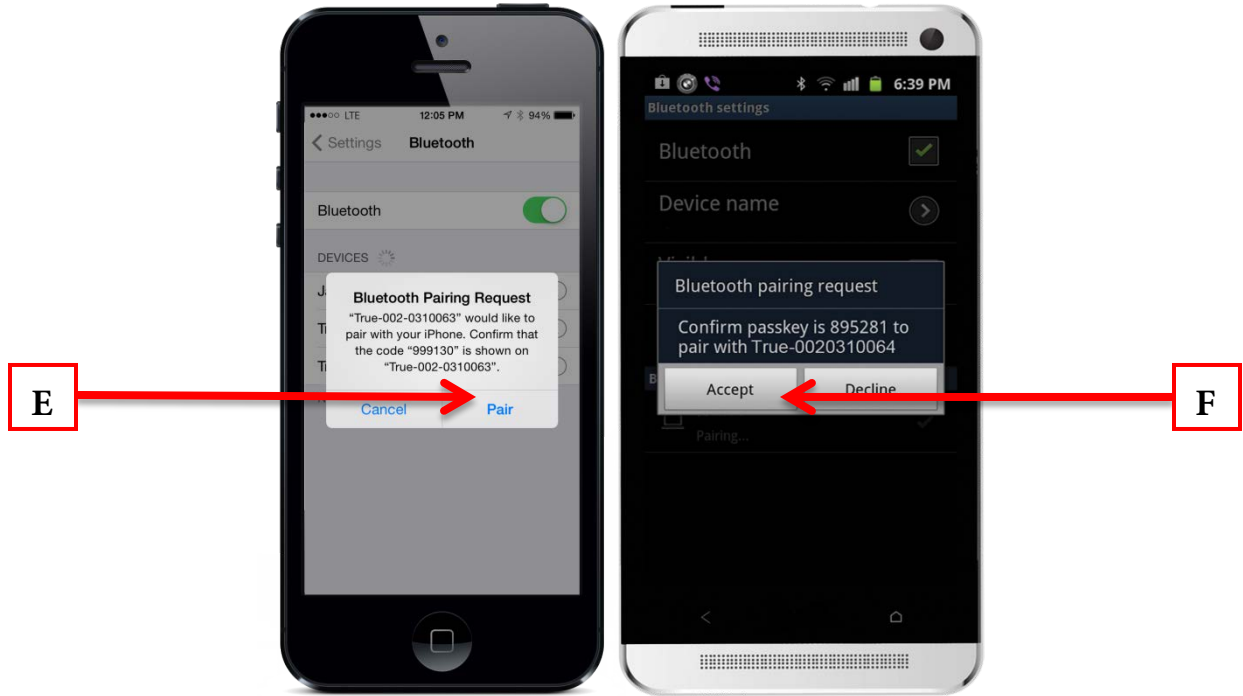

Once the Bluetooth pairing request has been accepted, the playback screen will be displayed. During playback, users can control volume (G), pause, advance or replay tracks by using the navigation buttons (H), and toggle between available audio sources by touching the Change Audio Button (I). To disconnect the Bluetooth audio device, simply touch the disconnect button (J).



CHAPTER 4A: TRANSCEND OPERATION

TV CONTROLS:

This console also features an integrated HDTV Tuner which allows the user to watch live programming in crisp, clear high Definition. The TV controls are built in to a Workout View Screen to allow the user to monitor their workout while enjoying their favorite shows.

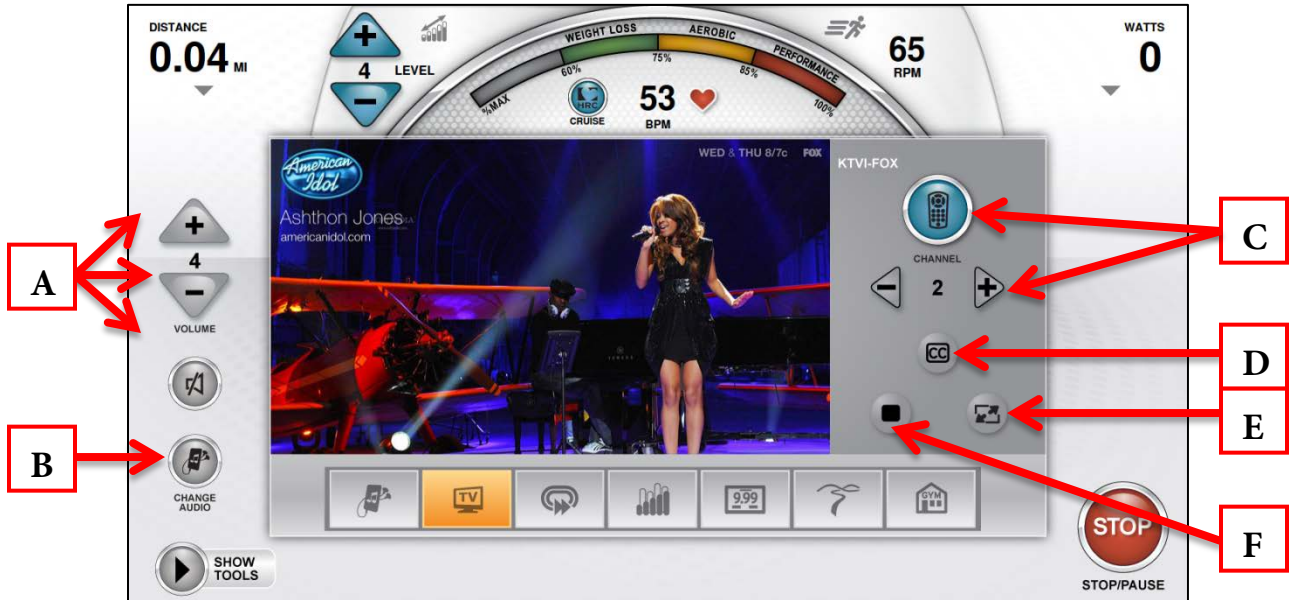

A) Volume Controls:

Increases, Decreases or Mutes the audio volume from the TV program.

B) Change Audio:

Toggles between available audio sources.

C) Channel Controls

Used to display a full list of available channels or to change channels one at a time.

D) Closed Captioning

Toggles the closed captioning on or off.

*This button will only be visible when the program displayed supports closed captioning.

E) Screen Toggle:

Allows the user to switch back and forth between full screen and regular mode.

F) Stop:

Stops the current TV/TV audio feed.

CHAPTER 4A: TRANSCEND OPERATION

VIRTUAL ACTIVE®:

Virtual Active® provides users with a scenic, first-person video to enhance a workout. Audio from the web browser, TV, iPod®, and Bluetooth sources can be combined with this feature by pressing the Change Audio Button (A) to create a truly unique workout. Additionally, The Workout View Screen controls and displays are still available when using this feature in standard mode. The video can be stopped, without ending the workout, at any time by touching the Stop Button (B). To display the video in full screen mode, simply touch the Screen Toggle Button (C). Audio Volume (D) can also be adjusted.

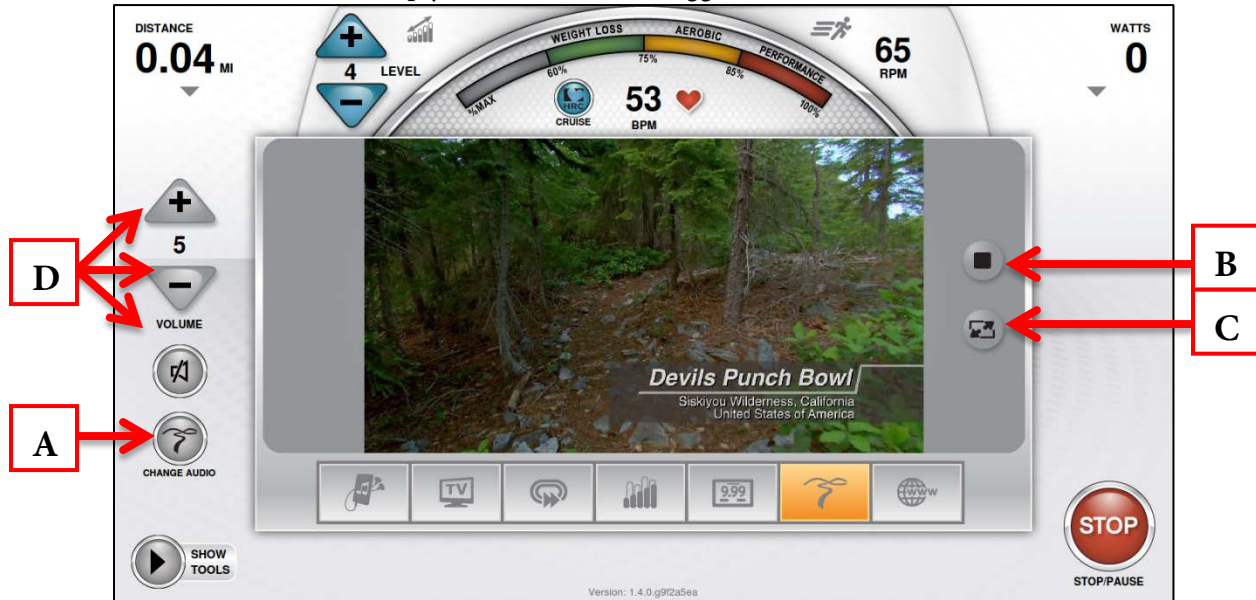

CHAPTER 4A: TRANSCEND OPERATION

ADVANCED CONSOLE FUNCTIONS:

⚠ WARNING:

Misconfiguration of the console may cause damage to the unit and void the manufacturer warranty. If necessary, please contact TRUE Fitness Technical Support at 800-883-8783 for assistance.

Entering Service Mode:

Entering Service Mode can be completed by pressing and holding the TRUE logo (A) in the upper left corner of the home screen. When the word "TRUE" (B) begins to flash, release the logo and press and hold the lower right corner of the screen (C).



Main Menu:

After successfully entering service mode the screen below will be displayed. From this menu users can access all of the service mode features by navigating through the various menus.

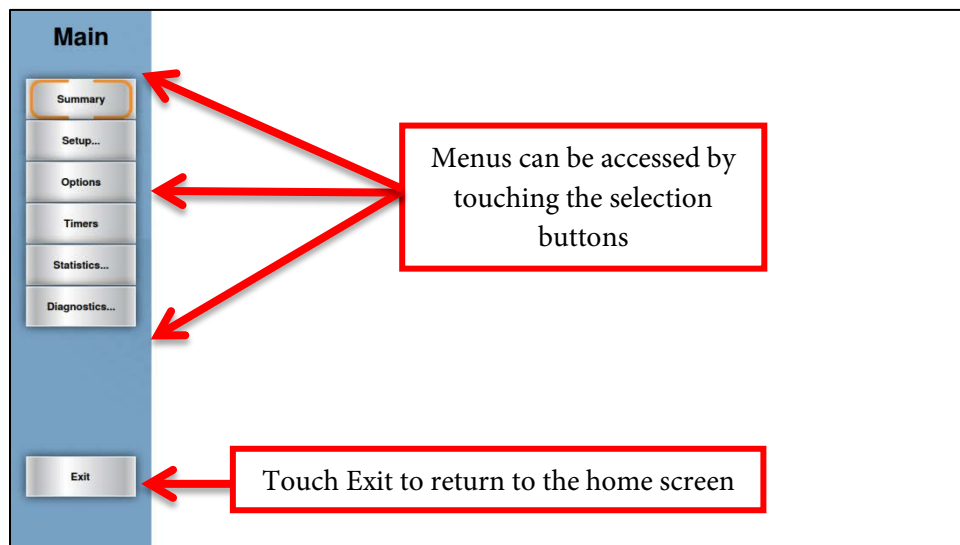

CHAPTER 4A: TRANSCEND OPERATION

ADVANCED CONSOLE FUNCTIONS (CONTINUED):

Summary Screen:

The Summary Screen will be the first screen displayed after entering service mode. This screen will give a general overview of the unit's setup.

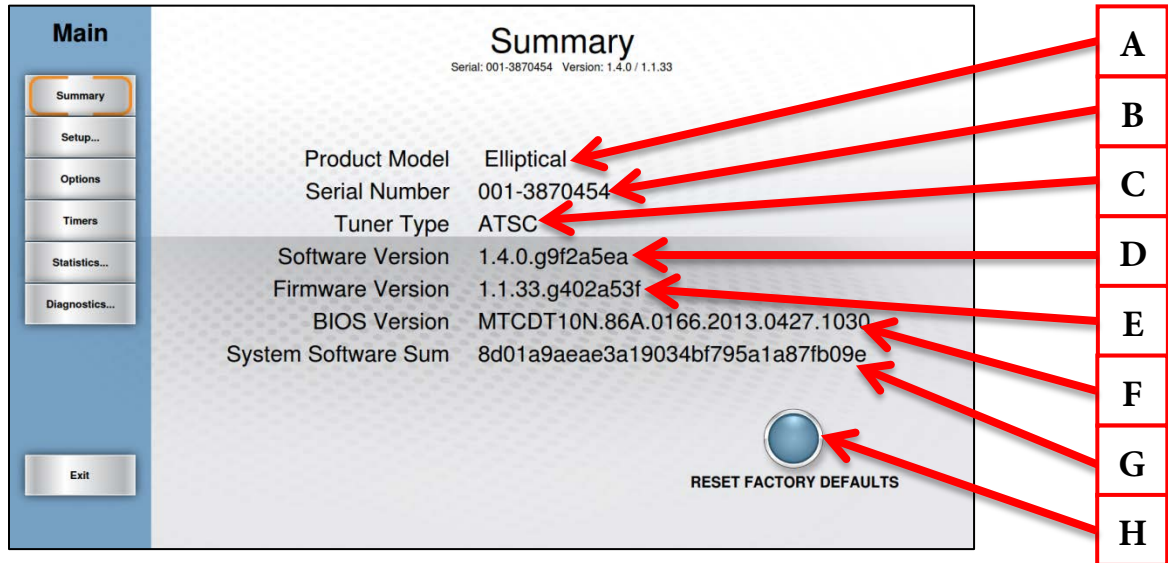

A) Product Model:

The model number that the console is currently configured to.

B) Serial Number:

The serial number of the console (not the base unit).

C) Tuner Type:

The type of TV tuner installed in the console.

D) Software Version:

The current version of software that is installed on the console.

E) Firmware Version:

The current version of firmware that is installed on the console.

F) BIOS Version:

The current BIOS version that is installed on the console.

G) System Software Sum:

Displays OS data that is used in the production of the console.

H) Reset Factory Defaults:

Resets all console settings to their factory defaults.

CHAPTER 4A: TRANSCEND OPERATION

ADVANCED CONSOLE FUNCTIONS (CONTINUED):

Setup Menu:

The setup menu is accessed by touching the Setup button on the main menu. The Setup Menu is separated into sub-categories and allows to users configure the console and to set up various functions of the unit.

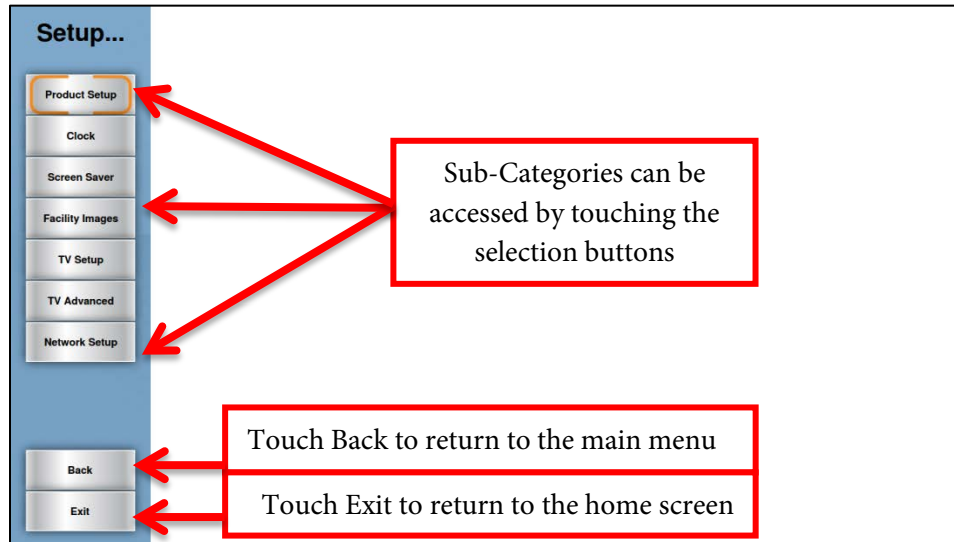

Setup Menu - Product Setup:

The Product Setup screen allows users to change the console configuration to match the unit on which it is installed. To change the console configuration:

- From the Main Menu, touch the Setup button.
- From the Setup Menu, Press Product Setup (A).
- Touch the correct model number to select it (B).
- Touch the Save key to save the configuration (C).

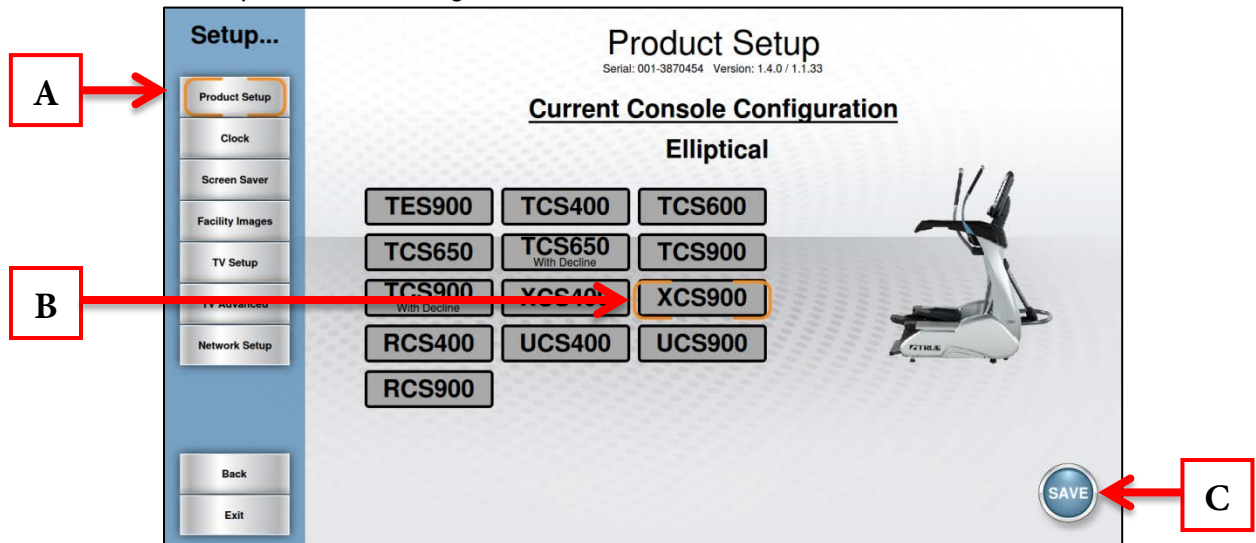

*Note: The Product Setup screen will only display the specific product that the console is currently located on. The above image shows all available options only for reference.

CHAPTER 4A: TRANSCEND OPERATION

ADVANCED CONSOLE FUNCTIONS (CONTINUED):

Setup Menu - Clock:

Correctly setting up the clock will ensure that all workout data that is exported by a user will be correctly labeled. Correct time is also important for troubleshooting purposes when viewing the system's error log.

Setting the Clock:

- From the Main Menu, press the Setup button.
- From the Setup Menu, press the Clock Button (A).
- Touch the arrows (B) to adjust the date and time and use the slider button (C) to select AM or PM.
- Once the correct time and date are entered, touch the Next key (D).
- Use the slider (E) or swipe through the list of time zones until the correct time zone is shown in bold (F).
- Touch the Save key (G).

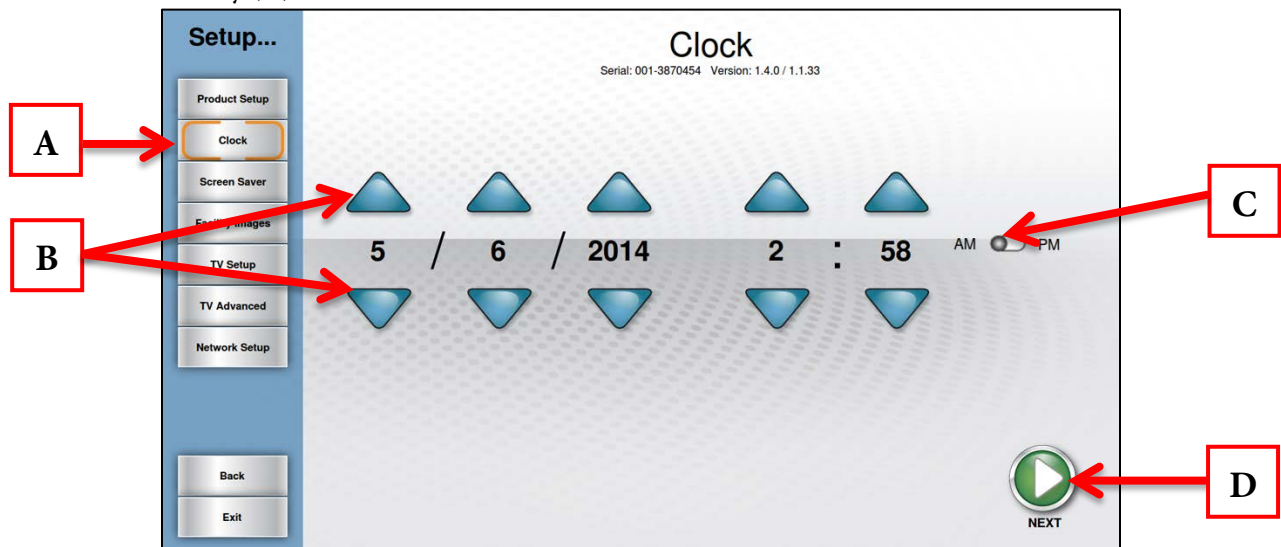

CHAPTER 4A: TRANSCEND OPERATION

ADVANCED CONSOLE FUNCTIONS (CONTINUED):

Setup Menu - Screen Saver:

Users can load JPG images to be used by the console as a custom screen saver. In order to be uploaded to the console, images will need to be placed on a USB drive in a folder named “screen saver” (case sensitive).

Importing Screen Saver Images:

- Touch the Screen Saver button (A)
- Insert the USB drive that contains the images into the console’s USB port.
- Verify the images in the preview window (B)
- Touch the Save button (C) to save the images to the console.

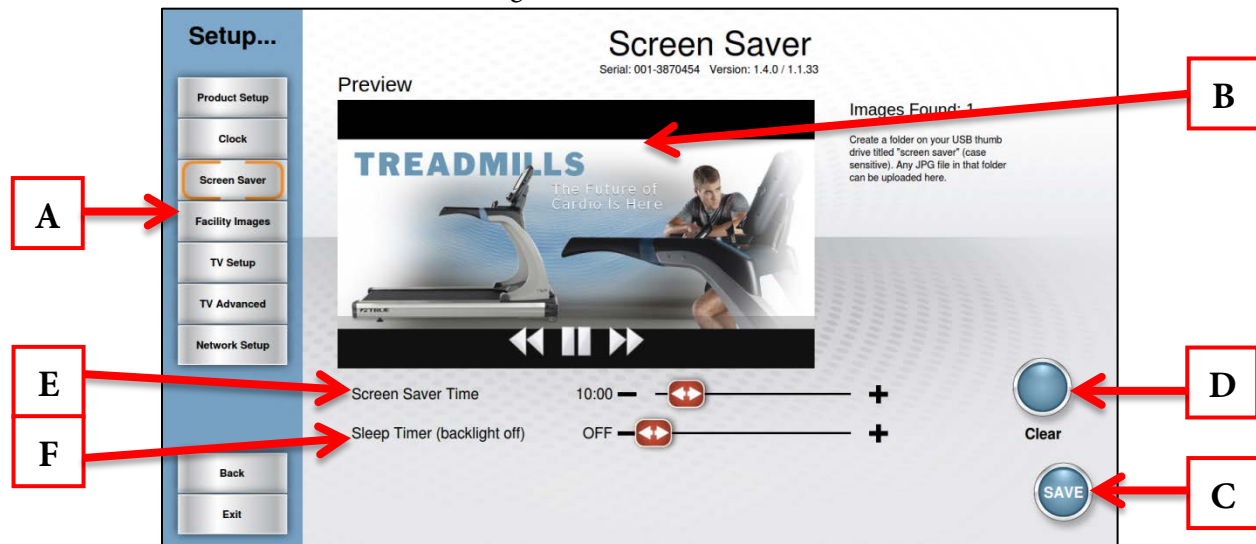

Additional Screen Saver Options:

- Custom Screen Saver images can be deleted by touching the clear button (D).
- The amount of time the console must be idle before the screen saver engages can be adjusted by using the Screen Saver Time Slider (E)
- The Sleep timer is a function that will turn off the console’s back light after a period of time to save energy. The amount of time the console must be idle before going to sleep can be adjusted by using the Sleep Timer Slider (F).

⚠️ WARNING:

Moving the Screen Saver Time completely to the left will disable the screen saver. Disabling the screen saver is not recommended and may cause damage to the screen and void the manufacturer warranty.

CHAPTER 4A: TRANSCEND OPERATION

ADVANCED CONSOLE FUNCTIONS (CONTINUED):

Setup Menu - Facility Images:

The Transcend console supports customizable facility images to help promote specials, events or endorse a brand. In order to be uploaded to the console, images will need to be placed on a USB drive in a folder named "facility" (case sensitive).

Importing Facility Images:

- Touch the Facility Images button (A)
- Insert the USB drive that contains the images into the console's USB port.
- Verify the images in the preview window (B)
- Touch the Save button (C) to save the images to the console.

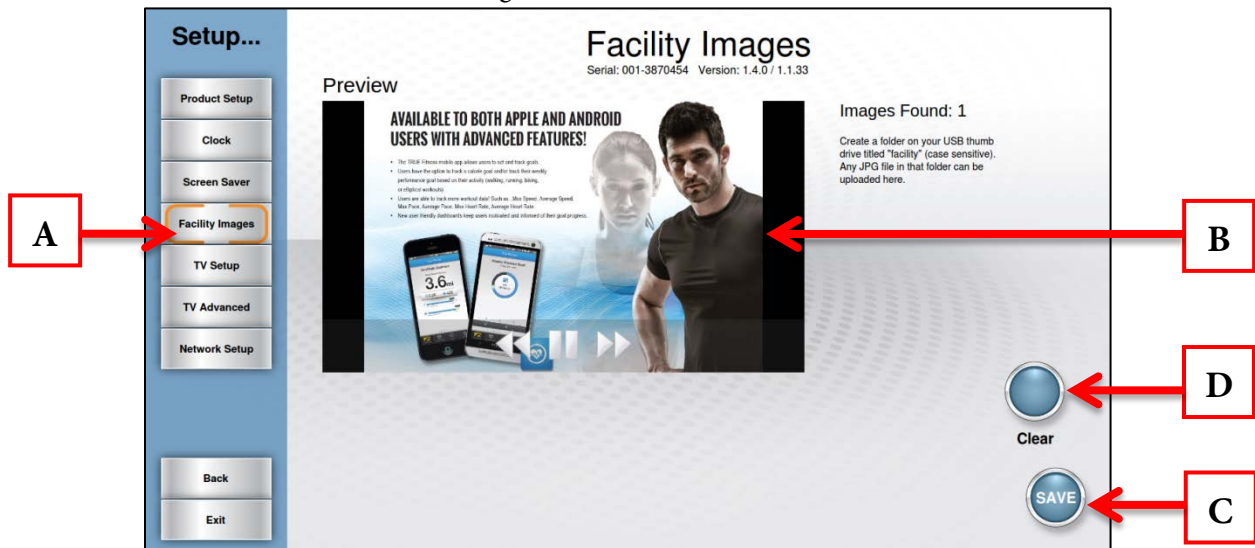

* Facility images can be deleted by touching the clear button (D).

Once loaded correctly, the facility Images will be displayed in the Facility Workout Data Screen (as shown below).

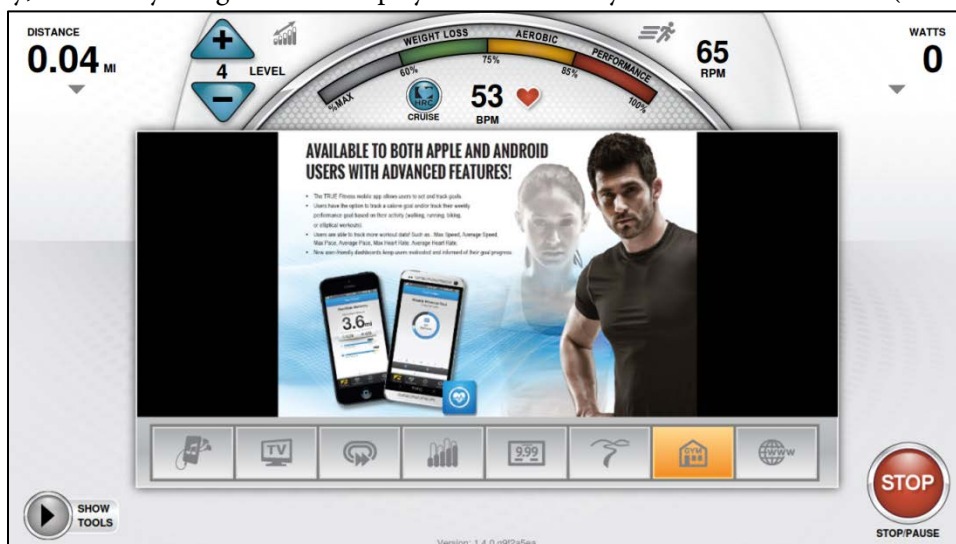

CHAPTER 4A: TRANSCEND OPERATION

ADVANCED CONSOLE FUNCTIONS (CONTINUED):

Setup Menu - TV Setup:

Transcend consoles have an integrated HDTV Tuner which allows the user to watch live programming in crisp, clear high Definition. Before any programming can be viewed, the TV signal needs to be set up. (TV Options will not be displayed on the Home Screen or in the Workout Data Screens until the TV Setup Steps have been completed)

TV Setup Steps:

- From the Setup Menu, touch TV Setup (A).
- Touch the type of signal that is being used to select it (B); Analog, Digital, or Both. (Digital is selected by default)
*When analog is selected the user will need to choose the analog standard (NTSC-M for the United States).
- Touch the Source Slider (C) to select between Antenna and Cable.
- Verify that the correct Country is listed (D).
- Touch Enable Aux Input (E) to enable or disable the AUX inputs located on the back of the console.
- Touch Begin Channel Scan (F) to begin scanning for channels.

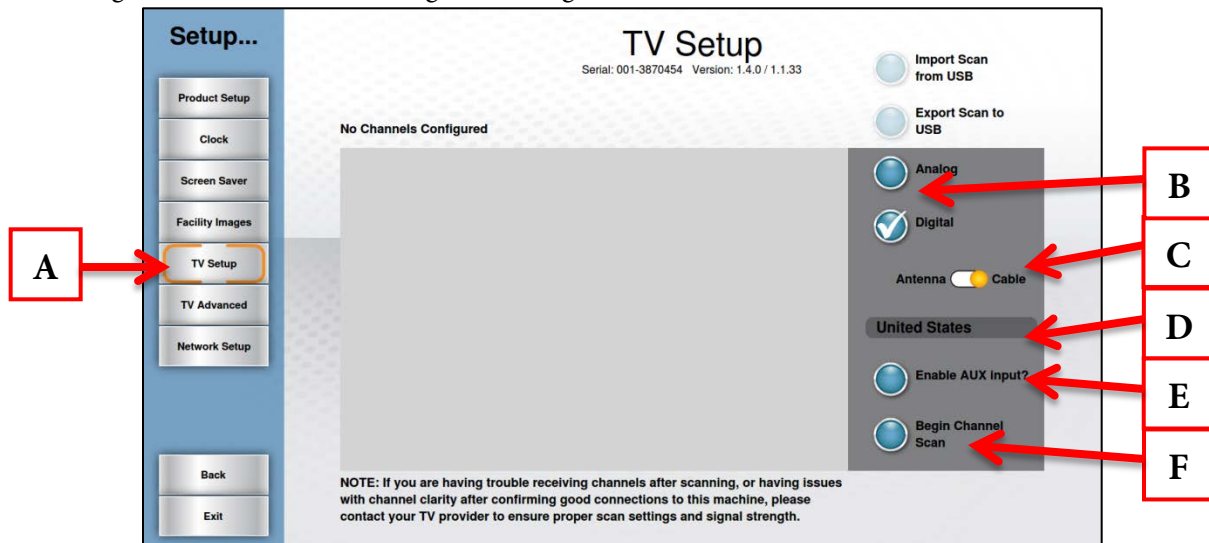

- Once the channel scan is complete, the channel list (G) will be populated with the available channels.

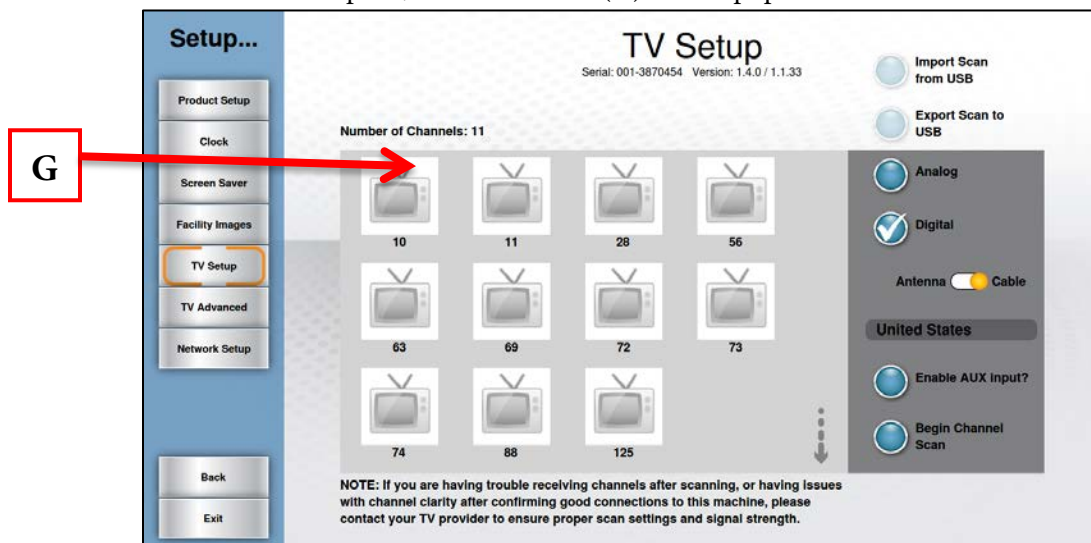

CHAPTER 4A: TRANSCEND OPERATION

ADVANCED CONSOLE FUNCTIONS (CONTINUED):

Setup Menu - TV Setup (continued):

Users can save time when setting up multiple units or maintain a back-up of their TV Setup Data by exporting it to a USB drive.

Exporting TV Setup Data to USB:

- Complete the TV Setup process.
- Insert a blank USB drive into the console's USB port.
- When all desired channels are listed in the Channel List (A), touch the Export Scan to USB Button (B)

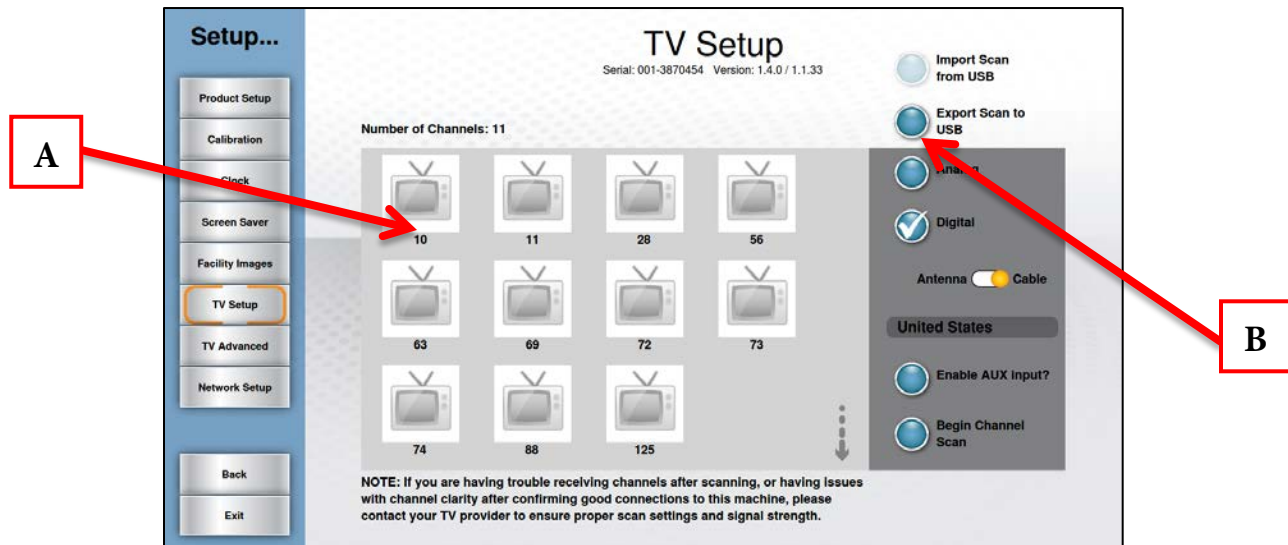

Importing TV Setup Data from USB:

- Navigate to the TV Setup screen.
- Insert the prepared USB stick into the console's USB Port.
- Touch Import Scan from USB (A).
- Once the import process is complete, verify that all channels are listed in the channel list (B).

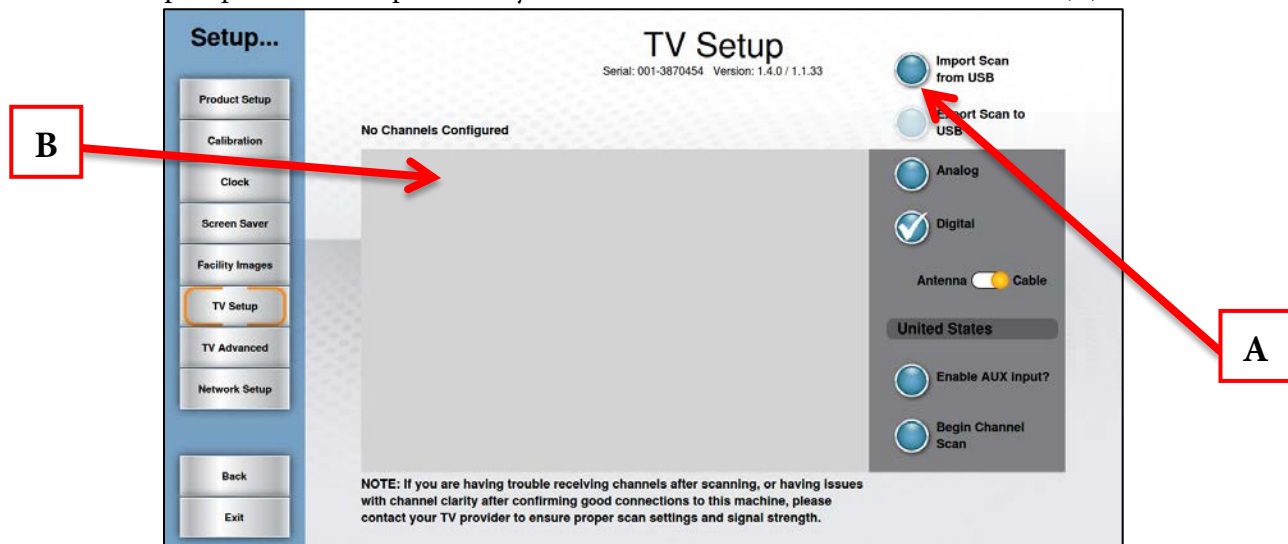

CHAPTER 4A: TRANSCEND OPERATION

ADVANCED CONSOLE FUNCTIONS (CONTINUED):

Setup Menu - TV Advanced:

The TV Advanced Menu allows users to fine tune their TV settings by adding channels, removing channels, and adding channel logos.

Add a Channel:

- Navigate to the TV Advanced Screen (A).
- Press the Add Channel Button (B) to access the Add Channel Screen.
- Use the Up/Down Arrows(C) to adjust the values (Standard, Frequency, Network, and Channel Number).
*Channel frequencies must be obtained from your television service provider.
- Once all values are correct, press OK (D) to save the channel.

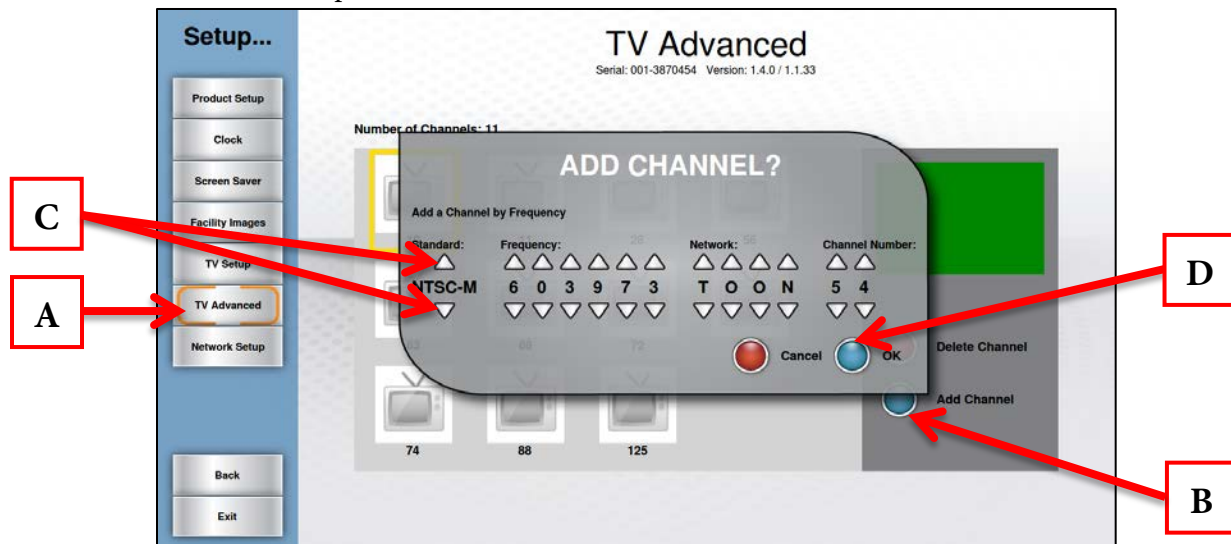

Deleting Channels:

- Touch the channel to be deleted to select it.
- Press the Delete Channel Button (A)
- Press Delete Channel (B) to delete the selected channel or Delete all Channels (C) to delete all channels.

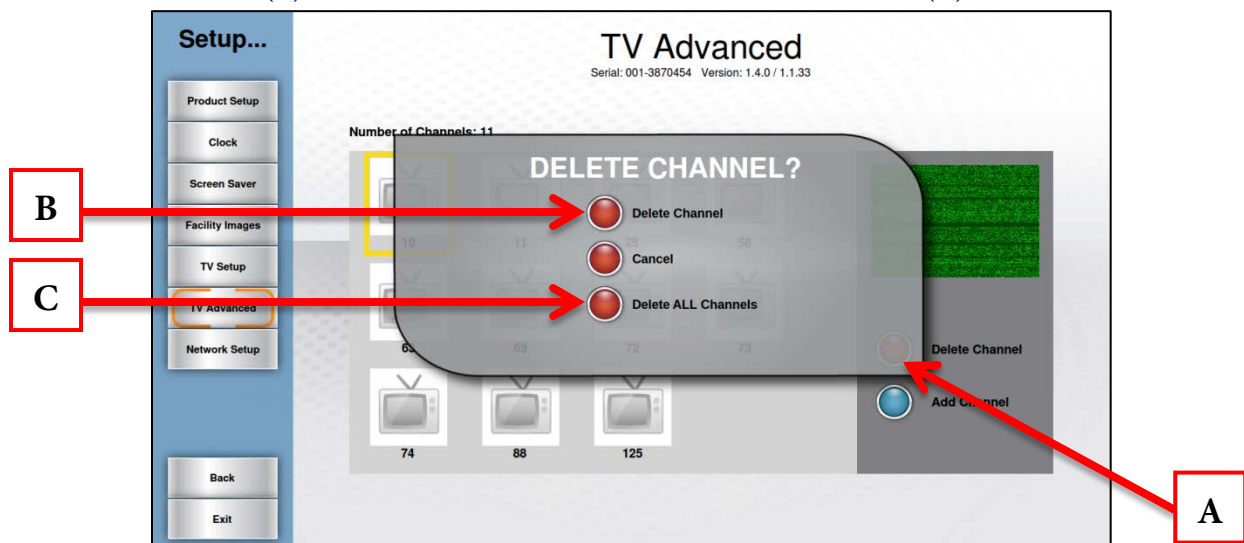

CHAPTER 4A: TRANSCEND OPERATION

ADVANCED CONSOLE FUNCTIONS (CONTINUED):

Setup Menu - TV Advanced (continued):

Using Channel logos allows users to quickly identify and select their favorite TV channels with minimal interruption to their workout.

Adding Channel Logos:

- Navigate to the TV Advanced Screen (A).
- Touch the desired channel in the Channel List (B) to select it
- Touch the channel again to enter the logo screen.

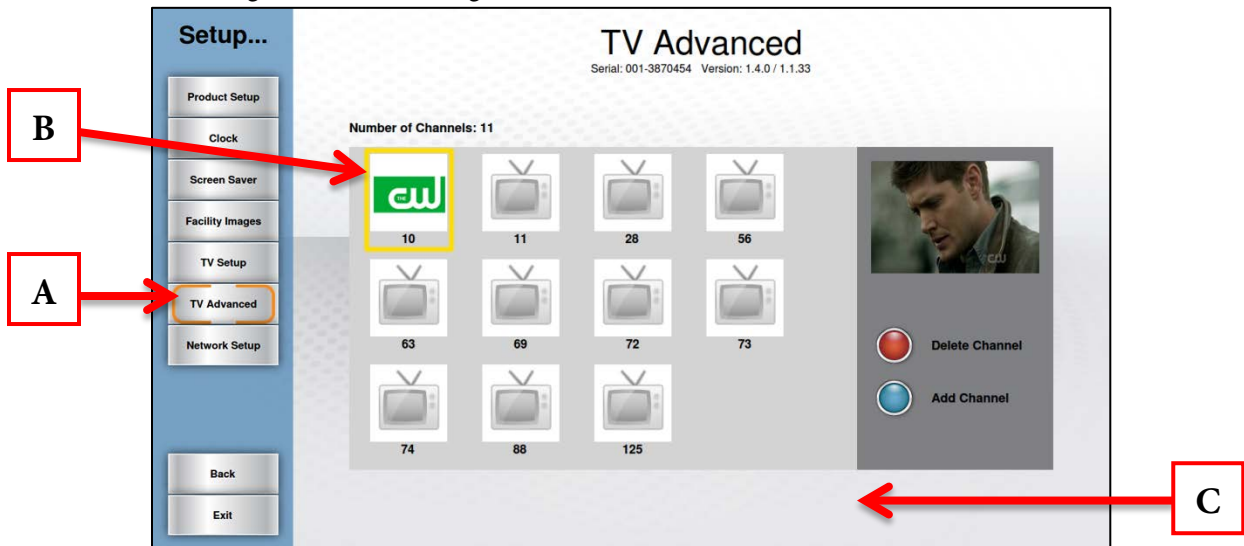

- Touch the logo (C) that corresponds to the selected channel.
- Repeat these steps for each channel for which a logo is available.



CHAPTER 4A: TRANSCEND OPERATION

ADVANCED CONSOLE FUNCTIONS (CONTINUED):

Setup Menu - Network Setup:

The Network Setup screen displays the current network information for the console. This screen also allows users to setup a wired or wireless internet connection and enable web browsing. To connect to a network, simply touch the Setup Connection button (A) and select the desired network from the list (and enter the password if necessary) and then press connect.

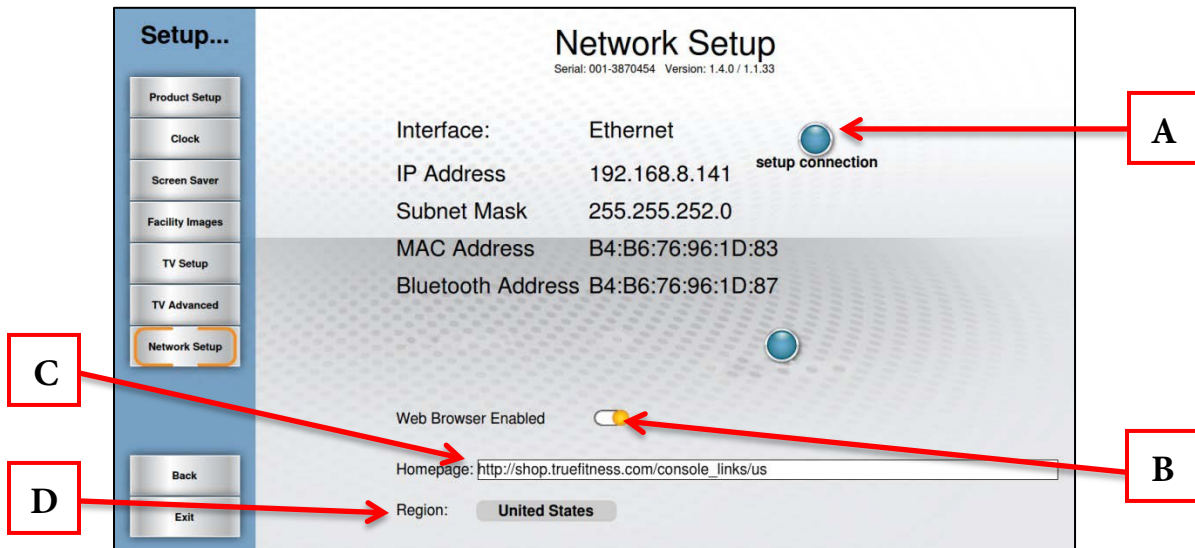

Enabling the Web Browser:

- Touch the Web browser Enabled Slider (B) to enable it.
- Accept the Internet Service Agreement.
- Select a homepage by touching the Homepage Address Bar (C) and typing the web address of the desired page and pressing Enter to confirm the page.
- Ensure that the correct Region (D) is displayed.

CHAPTER 4A: TRANSCEND OPERATION

ADVANCED CONSOLE FUNCTIONS (CONTINUED):

Options Menu:

The Options menu allows users to customize settings on the console to meet their needs. The settings in this menu save automatically.

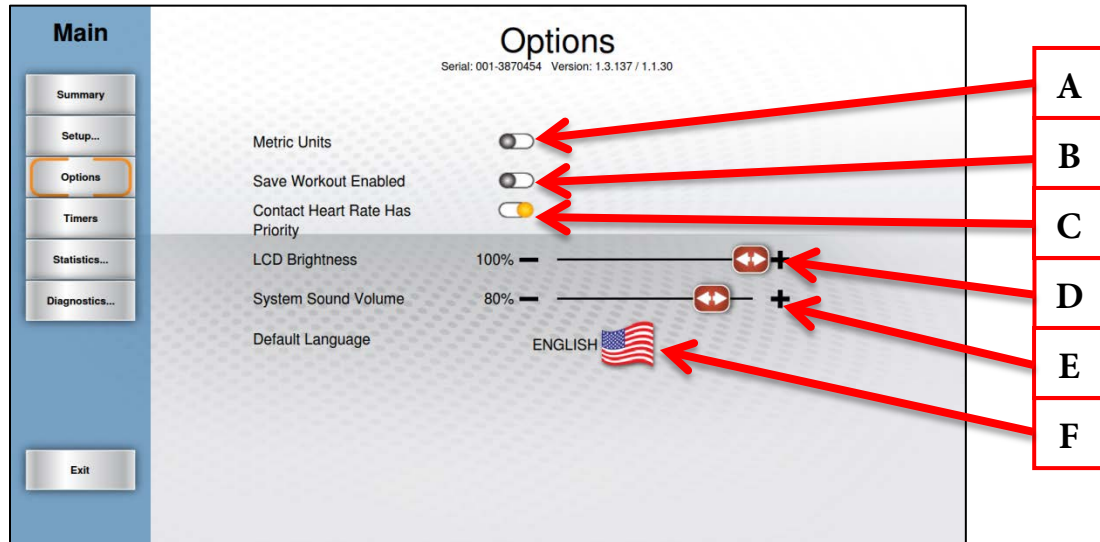

A) Metric Units:

When enabled, the console will display all Metric units rather than American Standard.

B) Save Workout Enabled:

Turn on this feature to allow users to save custom workouts to the console.

C) Contact Heart Rate Has Priority:

When enabled, the console will attempt to read heart rate data from the contact heart rate grips before reading data from a wireless chest strap.

*When this option is turned off, telemetry heart rate will take priority.

D) LCD Brightness:

Use the slider to adjust the brightness of the touchscreen display.

E) System Sound Volume:

Use the slider to adjust the volume of the notifications and beeps that come from the console.

F) Default Language:

Touch the flag to select a different language. Once a new default language has been selected, all menus, options and workout data will appear in that language.

CHAPTER 4A: TRANSCEND OPERATION

ADVANCED CONSOLE FUNCTIONS (CONTINUED):

Timers Menu:

The Timers Menu allows for time limits to be set on various console features and functions.

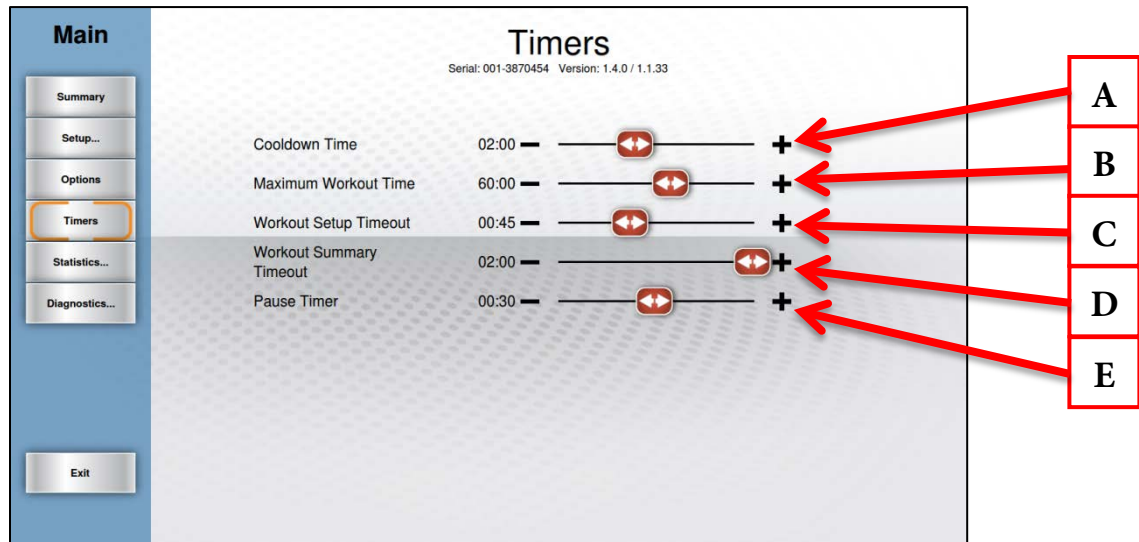

A) Cooldown Time:

Use the slider to adjust the length of the cooldown segment at the end of a workout.

B) Maximum Workout Time:

This setting will limit the amount of time that all workouts can last (this setting does not apply to quickstart workouts, manual workouts or distance workouts).

C) Workout Setup Timeout:

Choose how long the workout data entry screen will remain on the display without any user interaction. By choosing the “off” setting, the data entry screen will be displayed until closed by a user.

D) Workout Summary Timeout:

Determines the amount of time the Workout Summary Screen will remain on the display. By choosing the “Off” setting, the summary will be displayed until ended by a user.

E) Pause Timer:

This setting will limit the amount of time that a workout can be paused before it automatically ends. By choosing the “Off” option, the unit will remain paused until the user resumes or ends the workout.

CHAPTER 4A: TRANSCEND OPERATION

ADVANCED CONSOLE FUNCTIONS (CONTINUED):

Statistics Menu:

The statistics menu provides an overview of how and how long the unit has been used. Touching the summary button (A) will provide a usage summary. Run Hours (B) is the total number of hours the unit has been used. Machine Distance (C) is the total distance in miles that the belt has traveled. Distance (D) is the amount of distance the belt has traveled since the last time the Clear Mileage button (E) was pressed.

*The Distance/Clear Mileage feature is helpful for tracking mileage in a preventive maintenance schedule.

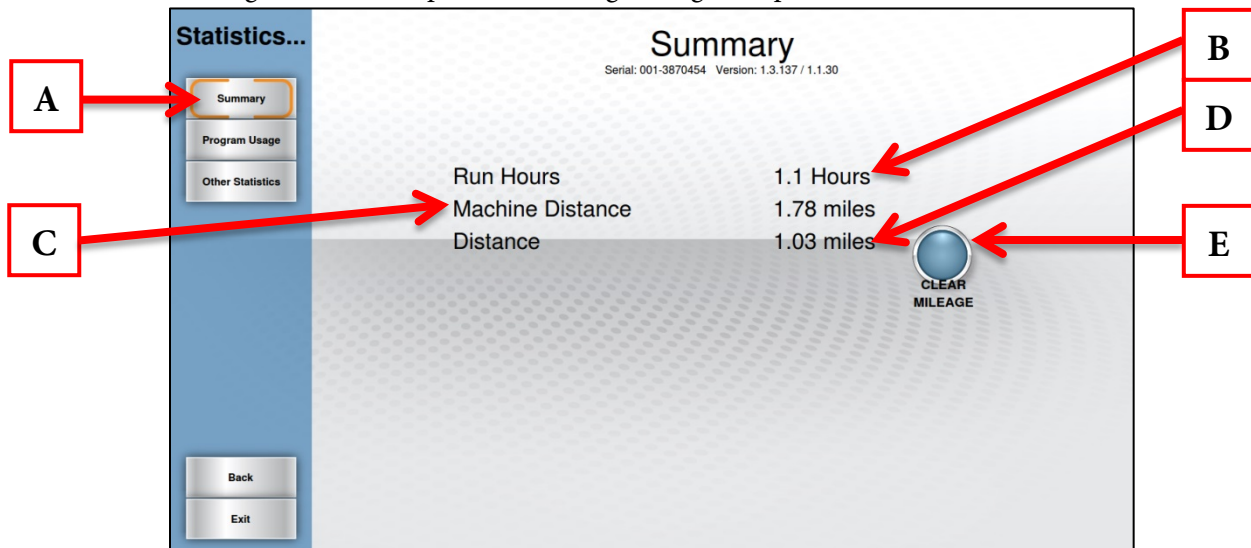

Touching the Program Usage button(C) will provide a list of programs that have been used on the unit and how many times those programs have been used. These statistics can be reset by touching the Clear button (D), but it is not recommended.

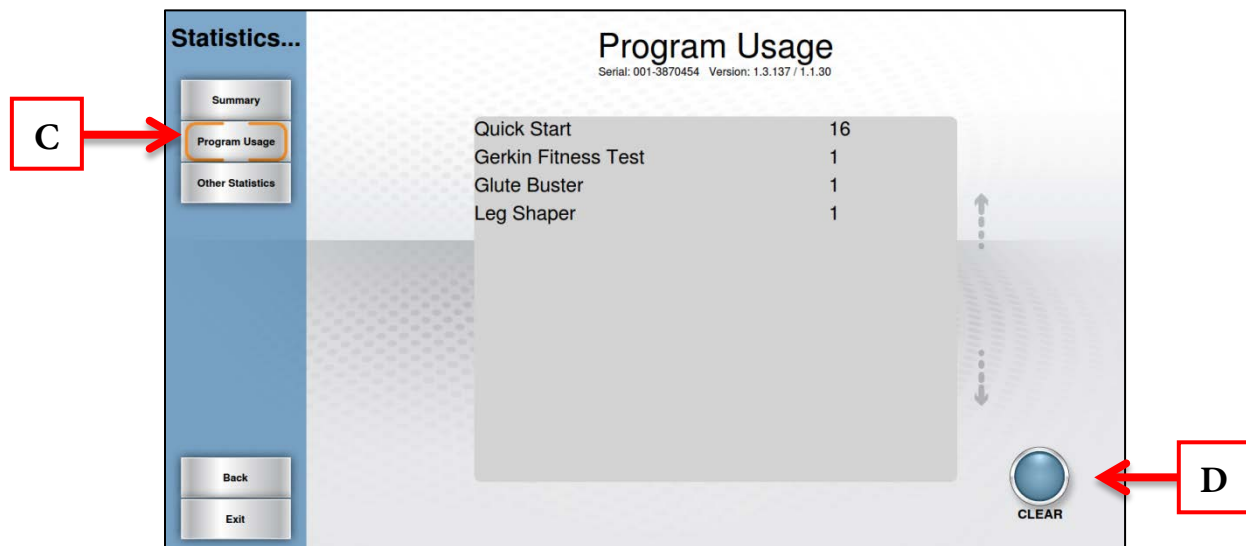

CHAPTER 4A: TRANSCEND OPERATION

Diagnostics Menu:

The Diagnostics Menu contains tools used to help diagnose errors and performance issues. The first screen displayed is Tests:

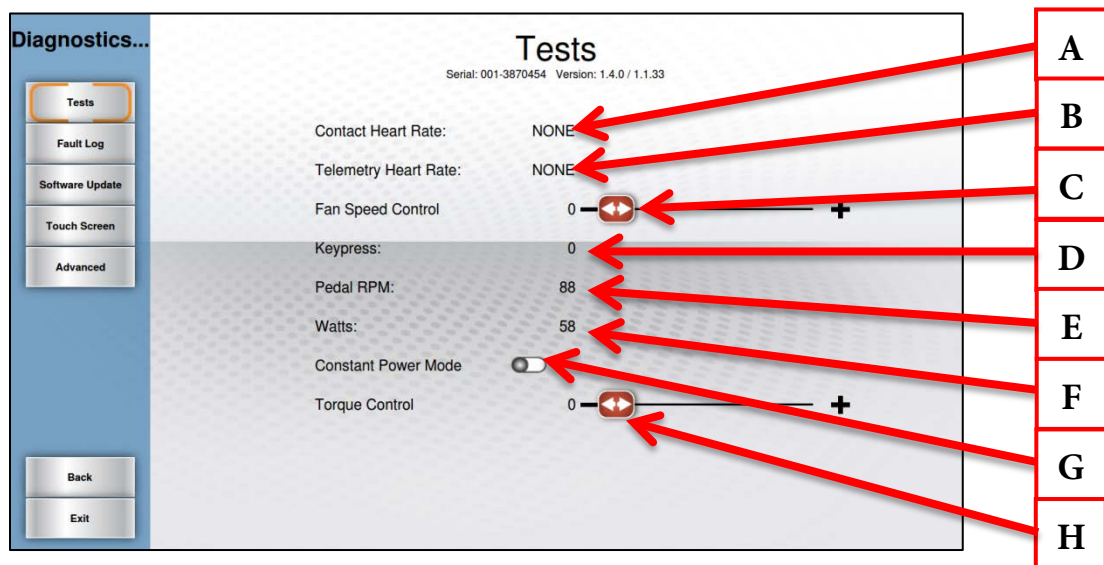

A) Contact Heart Rate:

Ensures the unit is receiving the data by displaying the user's heart rate when the contact heart rate pads are gripped.

B) Telemetry Heart Rate:

Use a wireless heart rate strap or simulator to test if the unit is receiving wireless heart rate data. If there is a reading displayed without the use of a heart rate strap or simulator, there is outside interference from another source.

*This unit is designed to receive 5 khz non-coded transmissions only.

C) Fan Speed Control:

Using the slider allows users to test the fan independent of a program.

C) Keypress:

When a quick access key is pressed on the unit, "NONE" will change to indicate which key is being pressed. In the event of a stuck key, the key that is being engaged will display.

E) Pedal RPM:

While a user is pedaling this value will display the current RPM for testing purposes.

F) Watts:

While a user is pedaling this value will display the current RPM for testing purposes.

G) Constant Power Mode:

A diagnostic brake test. *This setting should only be enabled by a TRUE Technical Support Representative.

H) Torque Control:

Manually Increases or decreases the resistance level, independent from a program to test brake function.

CHAPTER 4A: TRANSCEND OPERATION

ADVANCED CONSOLE FUNCTIONS (CONTINUED):

Diagnostics Menu - Fault Log:

Touching the Fault Log button (A) in the Diagnostics Menu, will display a time stamped list of recent fault codes that can be helpful in the troubleshooting process. The Fault Log can be reset by touching the Clear button (B), but it is not recommended.

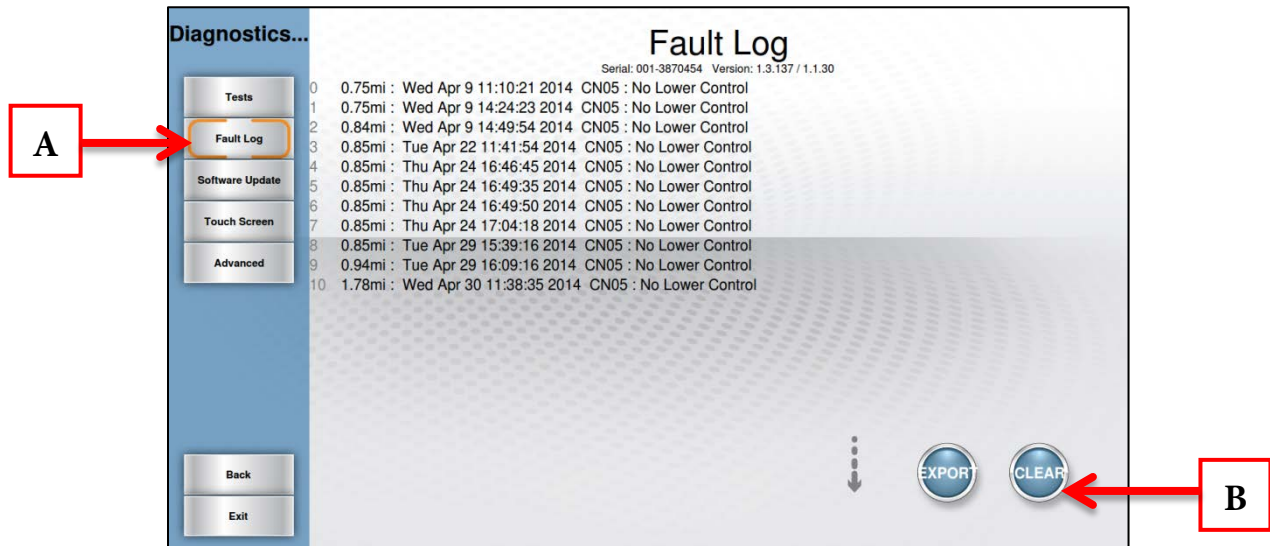

Diagnostics Menu - Software Update:

TRUE may periodically release software updates to ensure users enjoy the best workout experience available. To update the console software, download the update program (A) from truefitness.com and load the software to a blank USB drive by following the downloadable instructions.

***DO NOT place the installation program on the USB stick! The program must be run on a Windows based computer!**

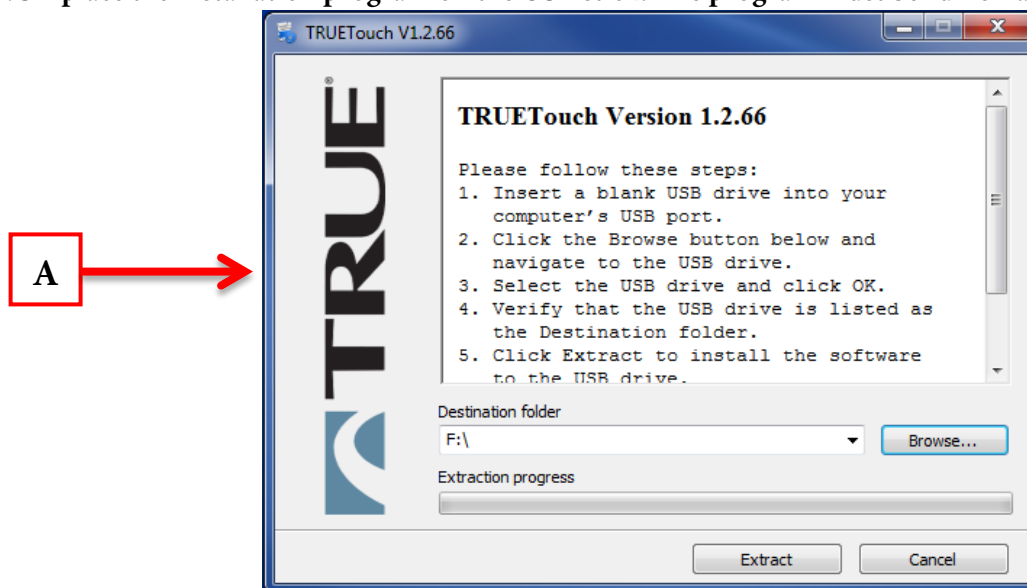

⚠️ WARNING:

Disconnecting the power source, switching the unit off or pressing buttons on the console will disrupt the information flow and potentially cause fatal errors.

CHAPTER 4A: TRANSCEND OPERATION

ADVANCED CONSOLE FUNCTIONS (CONTINUED):

Diagnostics Menu - Software Update (continued):

- Insert the USB drive containing the software update into the console's USB port.
- From the Main Menu, press the Diagnostics button. Then press Software update button (A).
- When the console locates the software update, press the Update Software button (B)
- After the installation of the software update, press the Load Firmware button (C).

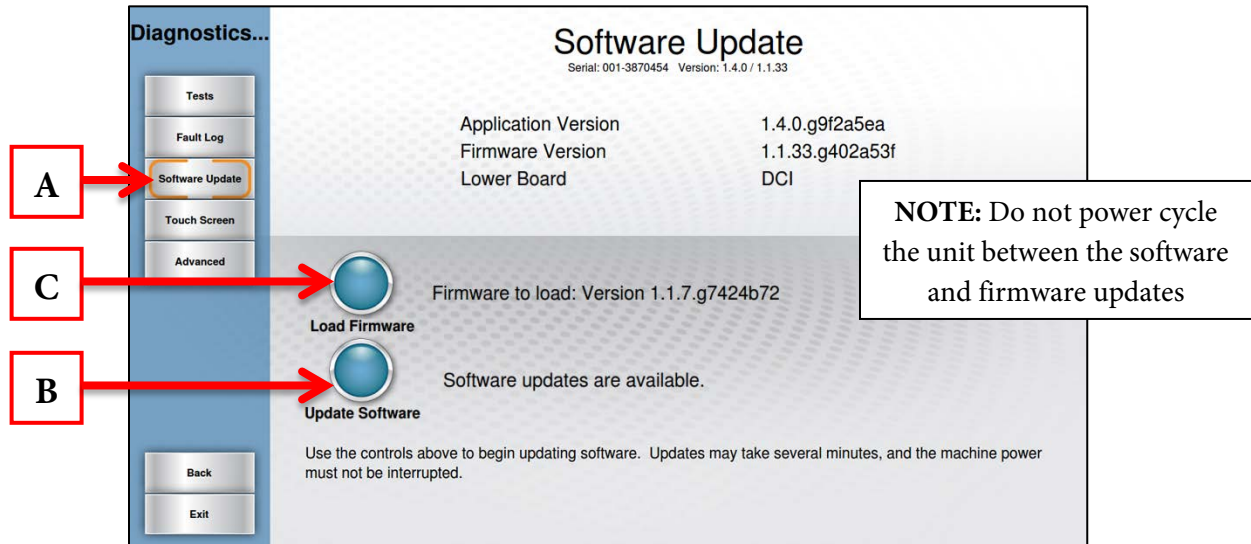

Diagnostics Menu - Touch Screen:

Touching the Touchscreen key (A) will open the touchscreen calibration tool. On the first screen displayed, users can touch anywhere in the white area (B) and a small red box (C) will appear to verify screen function. Touching the Calibrate button (D) will begin a touchscreen calibration. During this process, targets will appear on the screen and the user must press and hold each target until it turns red to complete the calibration.

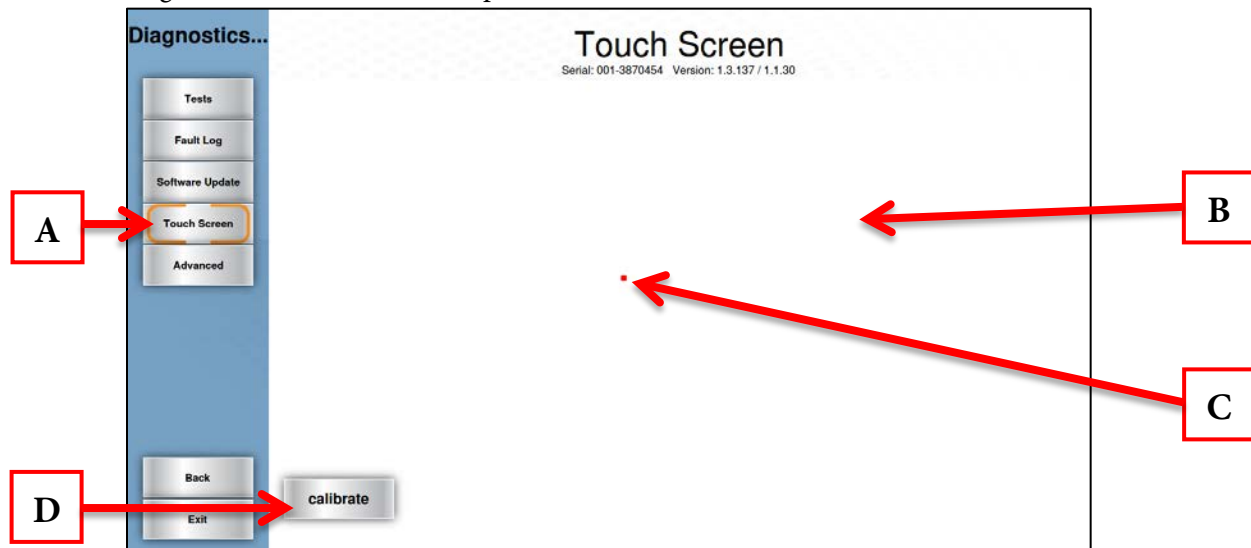

Diagnostics Menu - Advanced:

The advanced screen contains multiple tools that are used in the production of the console and for demonstration purposes. It is recommended to leave these settings in their default positions.

CHAPTER 4B: ESCALATE¹⁵ OPERATION

ESCALATE¹⁵ OVERVIEW:

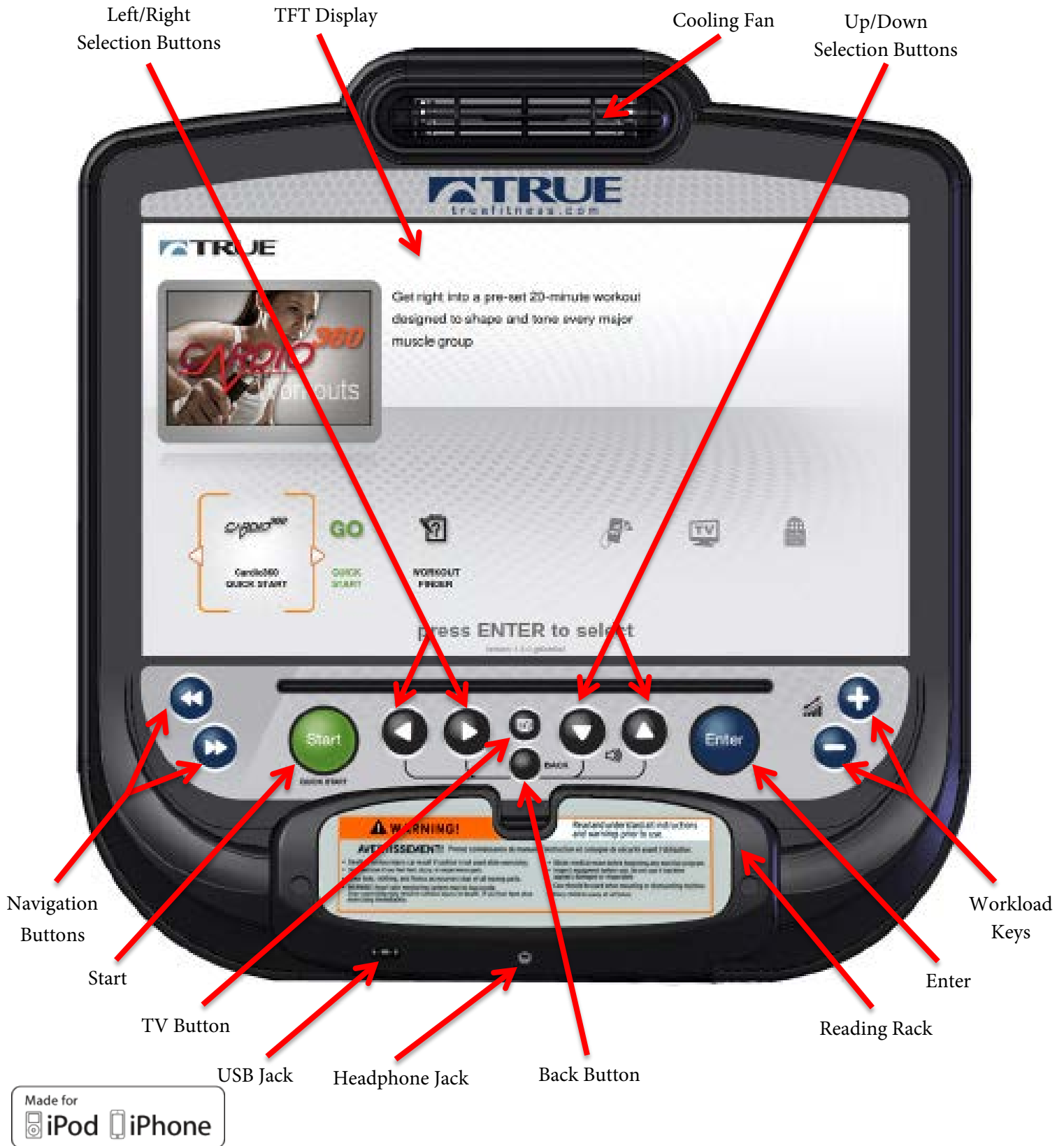

Made for
iPod iPhone

CHAPTER 4B: ESCALATE¹⁵ OPERATION

ESCALATE¹⁵ OVERVIEW (CONTINUED):

TFT Display:

Used to monitor or control a work out and feature navigation.

Selection Buttons:

Used to navigate menus and make selections via the LCD Display.

Navigation Buttons:

Used to navigate menus and control features of the console.

Start:

Allows the user to begin a Quick Start workout or preset workout.

TV Button:

Displays the TV interface.

USB Jack:

Allows users to export workout data to an external USB drive or update the console software.

Headphone Jack:

Standard 3.5mm audio jack used to connect headphones to the console during media playback.

Back Button

Used in navigate back within various console features.

Reading Rack:

This ledge on the console can be used to hold a book, magazine, e-reader, or tablet computer during a workout.

Enter:

Used to confirm selections.

Workload Keys:

Manually increases or decreases the workout intensity.

Cooling Fan:

Integrated fan that delivers a cooling flow of air during a workout.

CHAPTER 4B: ESCALATE¹⁵ OPERATION

CONSOLE NAVIGATION:

Home Screen:

The Home Screen is displayed on the console when there is no workout in progress. From this screen the user is able to select from various options to begin a workout or view media. To select an item, use the Left/Right selection buttons (A) to highlight the item and then press the Enter button (B).

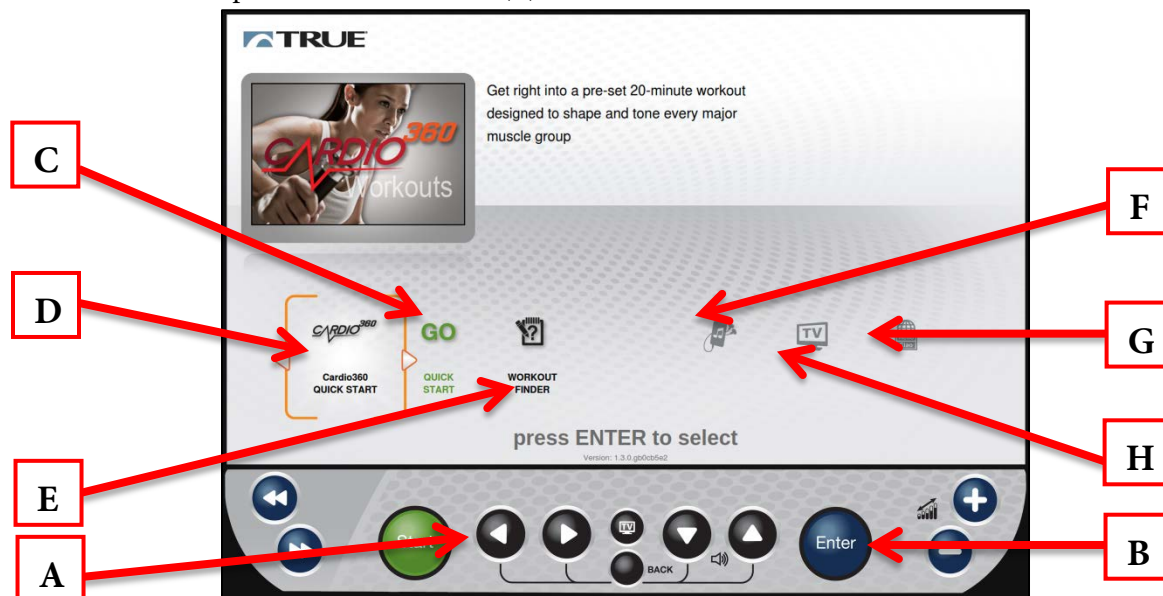

C) Quick Start

Starts a Quick Start workout in which the user controls all settings. The workout continues until it is ended by the user.

D) Cardio360™ Quickstart:

Begins a Cardio 360™ Quick Start Program

*See Program Descriptions Section

E) Workout Finder

Displays preset workouts categorized by goal focus categories.

F) iPod®/Audio Device

Displays the iPod®/Audio Device interface without starting a workout.

G) TV

Displays TV interface without starting a workout.

H) Language Options

Allows users to choose between 12 language options.

CHAPTER 4B: ESCALATE¹⁵ OPERATION

CONSOLE NAVIGATION (CONTINUED):

Selecting a Preset Workout:

Preset workouts are accessed by selecting the Workout Finder option on the home screen. Workouts are organized into 5 categories. To view the workouts in a category, select the category (A) by using the Left/Right Selection buttons (B) and then press Enter (C). Workouts can also be viewed in an uncategorized list by selecting the Show All Workouts option(C).



Workout Data Entry Screens:

Workout data entry screens allow the user to input their personal information or workout goals prior to beginning a preset workout. To set a value (A), select it using the Left/Right Selection Buttons (B) and then use the Up/Down Selection Buttons (C) to adjust the value to the desired setting. After all values are set, press start to begin the workout.

*Workout Data Entry Screens vary by program selection.



CHAPTER 4B: ESCALATE¹⁵ OPERATION

CONSOLE NAVIGATION (CONTINUED):

Workout View Screens:

During any workout a Workout View Screen will be displayed to give the user a comprehensive visual overview of their current workout data. Users can switch between the available Workout View Screens by using the Left/Right Selection Buttons (F).

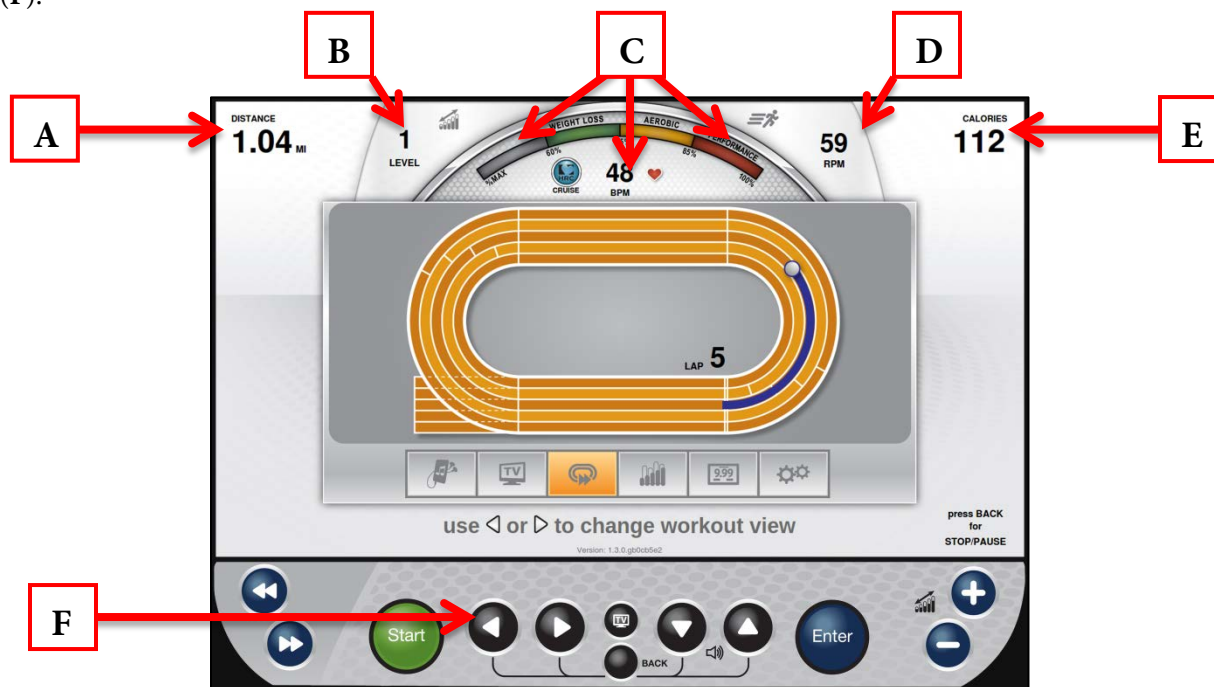

A) Data Display #1:

This display will toggle between multiple data points throughout the workout. These data points vary by program, but include Time, Distance, and Pace.

B) Workload Level:

Displays the current Workload level.

C) Heart Rate Information:

When the user is wearing a heart rate chest strap or utilizing the contact heart rate system, their heart rate will be displayed in beats per minute (bpm) and in the graphic meter. The graphic meter is based on age and will gauge the user's approximate heart rate within 3 target levels; Weight Loss, Aerobic or Performance.

D) RPM:

Displays the current pace of a workout.

E) Data Display #2:

This display will toggle between multiple data points throughout the workout. These data points vary by program, but include Calories, Distance, and METS.

CHAPTER 4B: ESCALATE¹⁵ OPERATION

CONSOLE NAVIGATION (CONTINUED):

Tools Screen Controls:

The Tools Screen contains controls that allow users to adjust settings during their workout. The Tools screen can be reached by using the Left/Right Selection Buttons (A) during any workout. The Navigation Buttons (B) are used in the Tools Screen to select between the available options. Once the desired tool has been selected, press Enter (C) to confirm the selection.

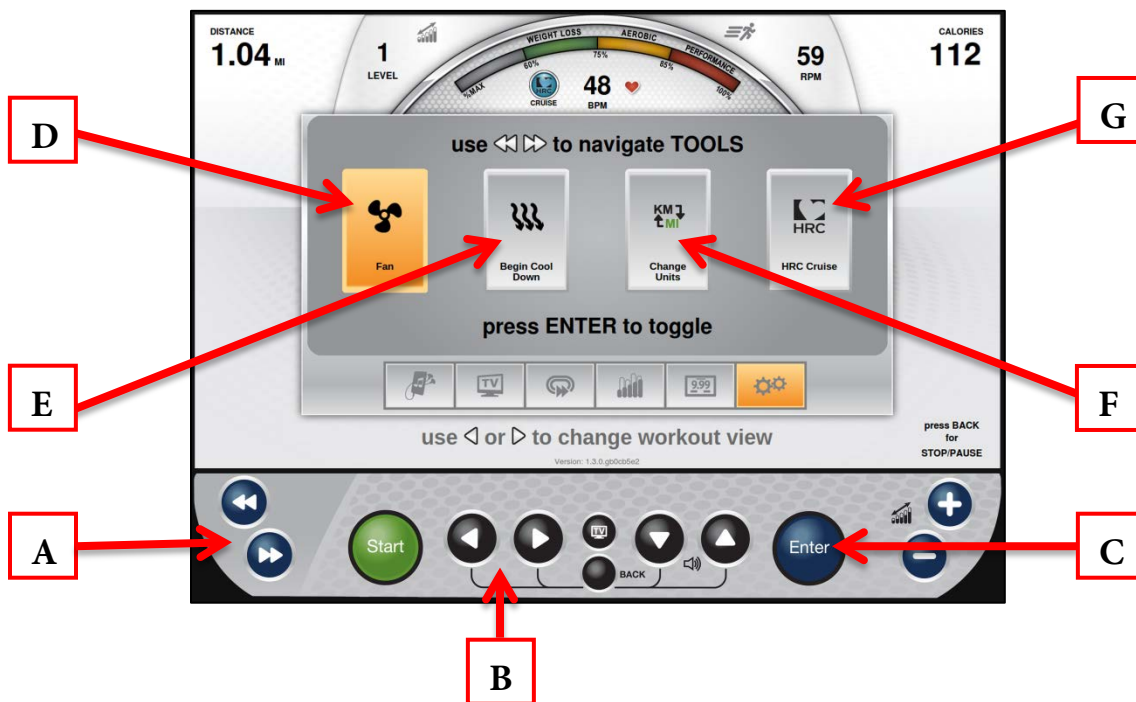

D) Fan:

This tool toggles the cooling fan on and off.

E) Cool Down:

Allows the user to end their current workout with a two minute low intensity cool down period. When Cool Down is activated the unit is in manual mode and the user directly controls all settings.

F) Change Units:

Allows users to change the data readouts between English Standard and Metric Units.

G) HRC Cruise Control:

Engages Heart Rate Control to allow the equipment to maintain the user's current heart rate through automatic speed and incline adjustments (when the user is utilizing heart rate monitoring).

CHAPTER 4B: ESCALATE¹⁵ OPERATION

CONSOLE NAVIGATION (CONTINUED):

Cardio 360™:

TRUE's unique Cardio 360™ is like having a personal trainer built in to the elliptical, walking users through a full-body workout. In just minutes, users will work their upper-body, lower-body and core. Plus, with the variety that Cardio 360™ brings, it will take the bore out of working out. The program walks users through the various movements they need to do to achieve the complete workout, so all they need to do is commit to stepping on the machine.

During a Cardio 360™ program the Cardio 360™ Workout Data Screen will be displayed to guide users through the program.

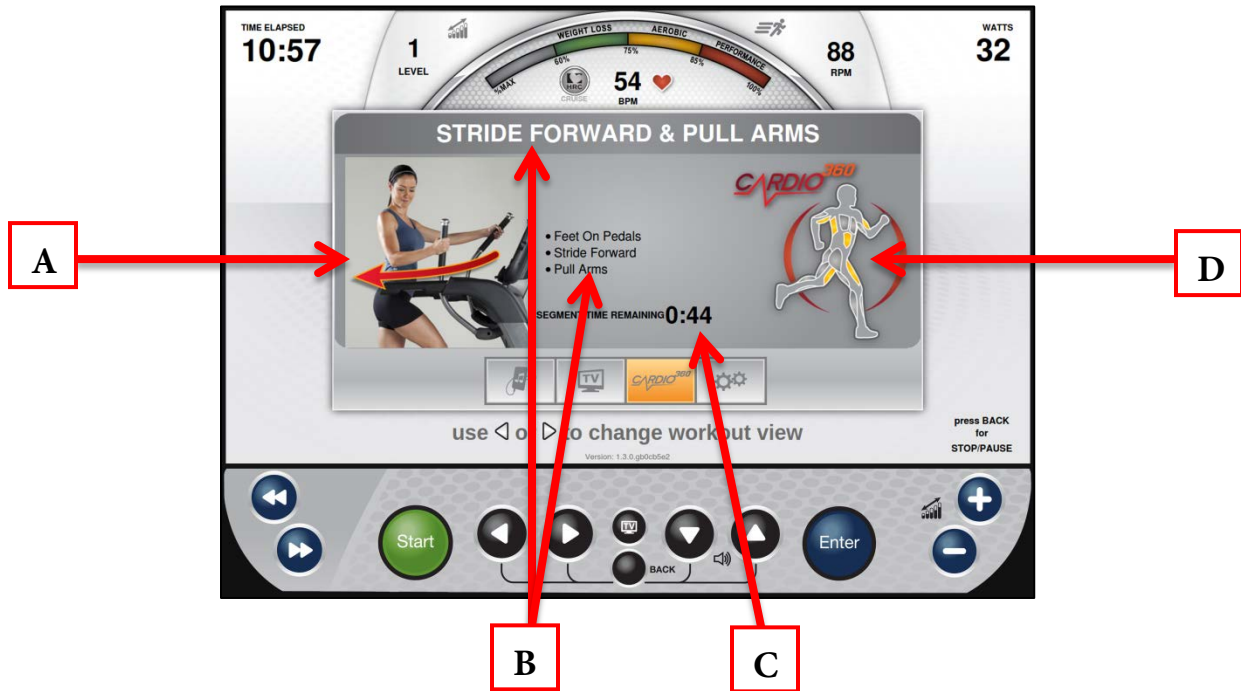

A) Example Window:

Gives users a visual example of the current workout segment.

B) Workout Directions:

Tells the user what actions to take during a workout segment.

C) Segment Time Remaining:

Displays the time remaining in the current workout segment.

D) Target Display:

Highlights the muscle groups being targeted during the current workout segment.

CHAPTER 4B: ESCALATE¹⁵ OPERATION

CONSOLE NAVIGATION (CONTINUED):

Workout Summary Screen:

At the end of a workout the Summary Screen will display an overview of the workout data. The workout data can be exported to the TRUE Fitness App via Bluetooth or to a USB drive that is connected to the console's USB port. To export the Workout Data, use the Left/Right Selection Buttons (A) to select Save (B) and then press the Enter Button (C). If the user requires more time to view the summary or to export the workout data, they can select More Time (D) and press the Enter Button (C) to extend the time that the summary remains on the screen.

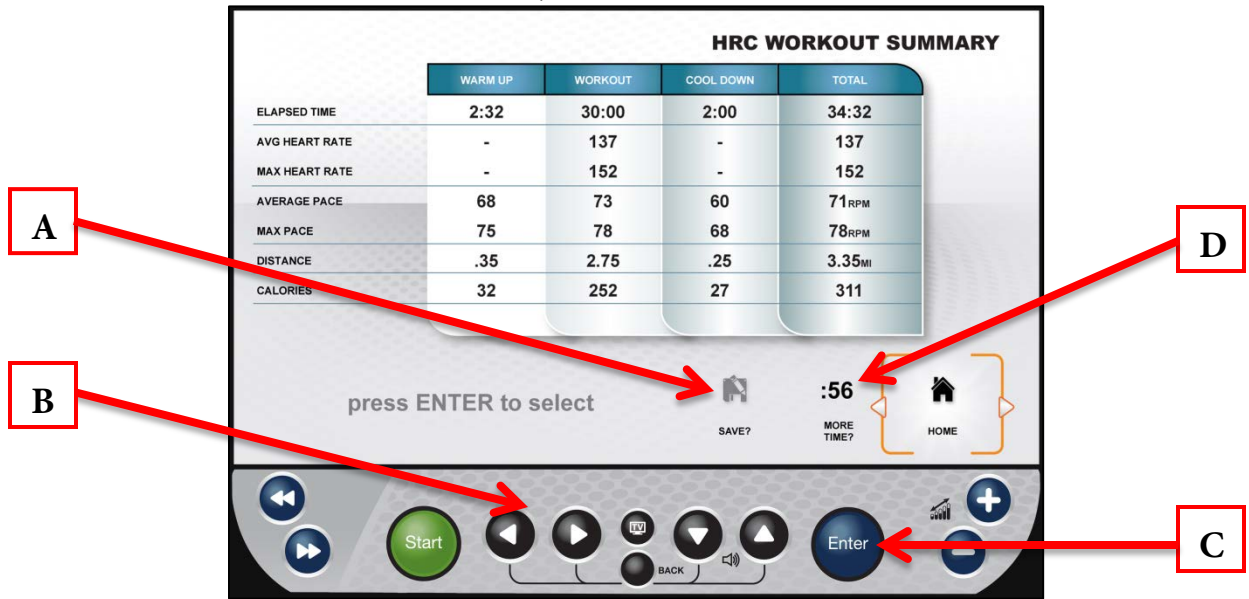

TV CONTROLS:

This console has an integrated HDTV Tuner which allows the user to watch live programming in crisp, clear high Definition. The TV controls are built in to a Workout View Screen to allow the user to monitor their workout while enjoying their favorite shows. While watching TV, users can control volume using the Up/Down Selection buttons (A) and change channels using the Navigation Buttons (B) or by selecting a channel from the list of available channels by pressing the TV Button (C). To enter full screen mode, simply press the Enter Button (D).



CHAPTER 4B: ESCALATE¹⁵ OPERATION

BLUETOOTH AUDIO:

The Escalate¹⁵ console has integrated Bluetooth support for Bluetooth enabled audio devices. To pair a device with the console, use the Left/Right Selection Buttons (A) to select the iPod®/Audio Device Screen. Ensure that the device is discoverable via Bluetooth and press the Enter Button (B) to search for devices.



The console will complete a scan for available Bluetooth devices. Once the scan is complete, use the Up/Down Selection Buttons (C) to select the desired device from the list of available devices and press Enter (D).

*If the device is not listed, verify that it the Bluetooth is enabled and that the device is discoverable. Use the Up/Down Selection Buttons (C) to select Refresh List and Press Enter (D) to re-scan for the Bluetooth device.



CHAPTER 4B: ESCALATE¹⁵ OPERATION

BLUETOOTH AUDIO (CONTINUED):

When a device is selected from the list, the console will send a pairing request to that device. The pairing request must be accepted in order for this feature to operate. For iOS devices, press Pair (E) to accept the request. For Android devices, press Accept (F) to accept the request.

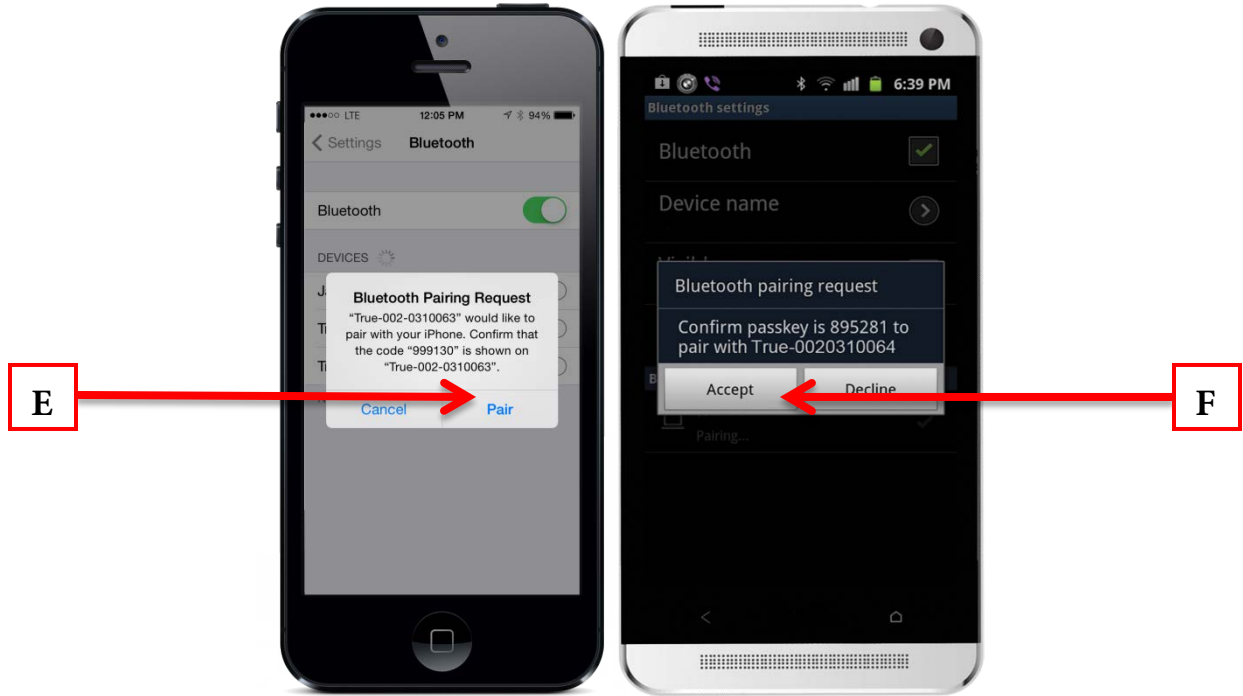

Once the Bluetooth pairing request has been accepted, the playback screen will be displayed. During playback, users can control volume by using the Up/Down Selection buttons (G) and advance or replay tracks by using the navigation buttons (H).



CHAPTER 4B: ESCALATE¹⁵ OPERATION

ADVANCED CONSOLE FUNCTIONS:

Entering Service Mode:

Entering Service Mode can be completed by pressing and holding the Back navigation Button (A). When the TRUE Logo (B) begins to flash, release the navigation button and press and hold the Enter Button (C).

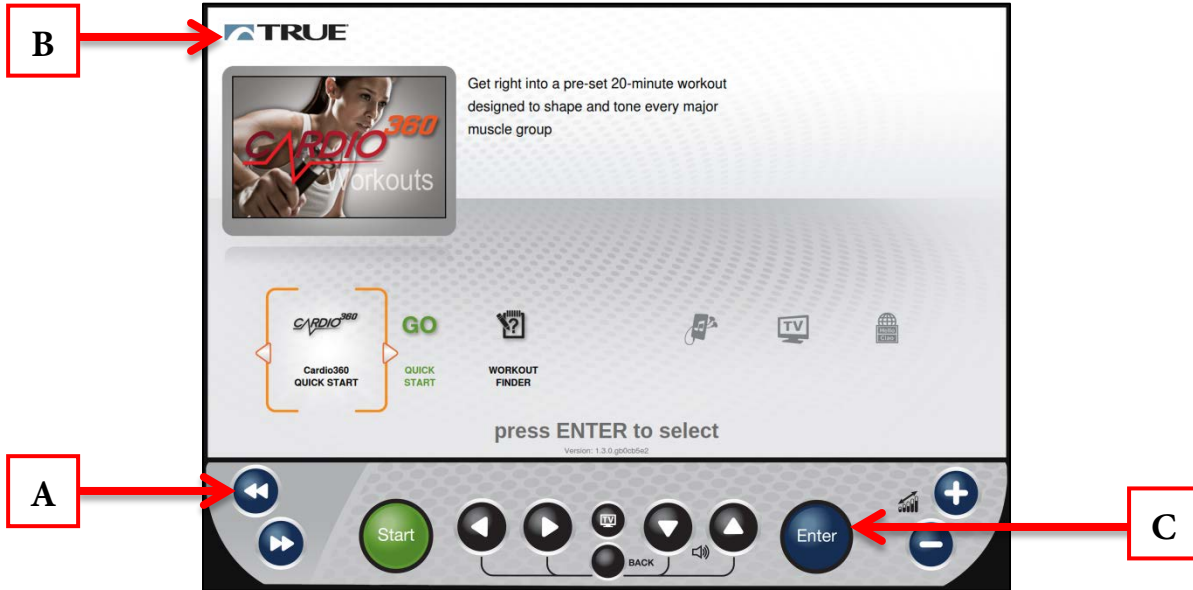

Main Menu:

After successfully entering service mode the Main Menu will be displayed. From this menu users can access all of the service mode features by navigating through the various menus.

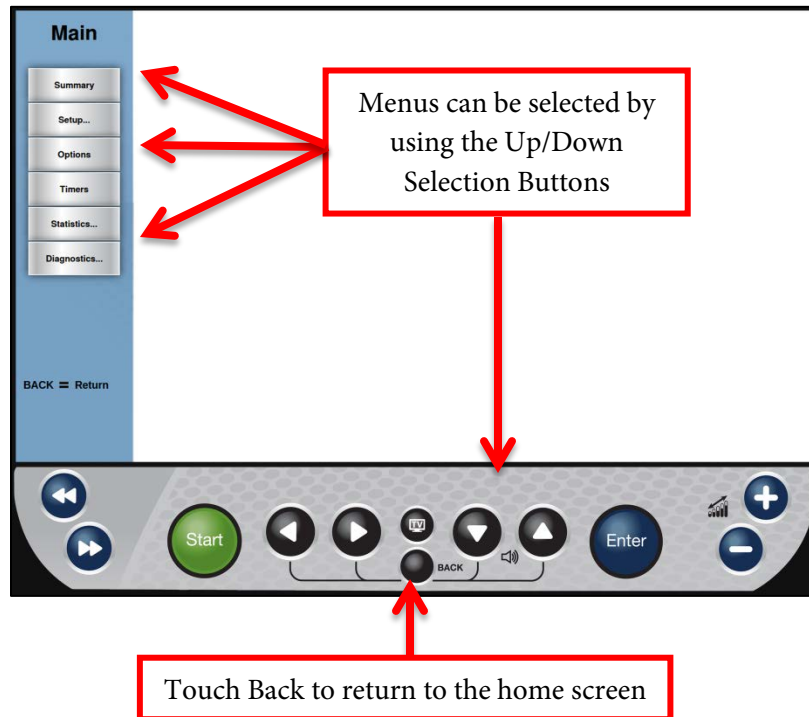

CHAPTER 4B: ESCALATE¹⁵ OPERATION

ADVANCED CONSOLE FUNCTIONS (CONTINUED):

Summary Screen:

The Summary Screen will be the first screen displayed after entering service mode. This screen will give a general overview of the unit's setup.

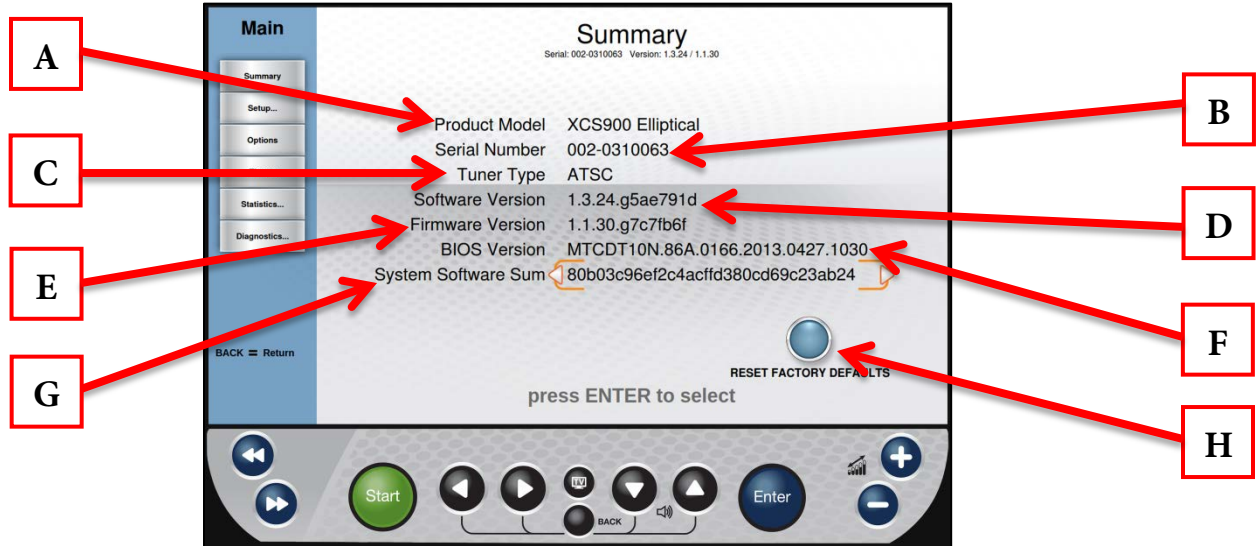

A) Product Model:

The model number that the console is currently configured to.

B) Serial Number:

The serial number of the console (not the base unit).

C) Tuner Type:

The type of TV tuner installed in the console.

D) Software Version:

The current version of software that is installed on the console.

E) Firmware Version:

The current version of firmware that is installed on the console.

F) BIOS Version:

The current BIOS version that is installed on the console.

G) System Software Sum:

Displays OS data that is used in the production of the console.

H) Reset Factory Defaults:

Resets all console settings to their factory defaults.

CHAPTER 4B: ESCALATE¹⁵ OPERATION

ADVANCED CONSOLE FUNCTIONS (CONTINUED):

Setup Menu:

The setup menu is accessed by touching the Setup button on the main menu. The Setup Menu is separated into seven sub-categories and allows to users configure the console and to set up various functions of the unit.

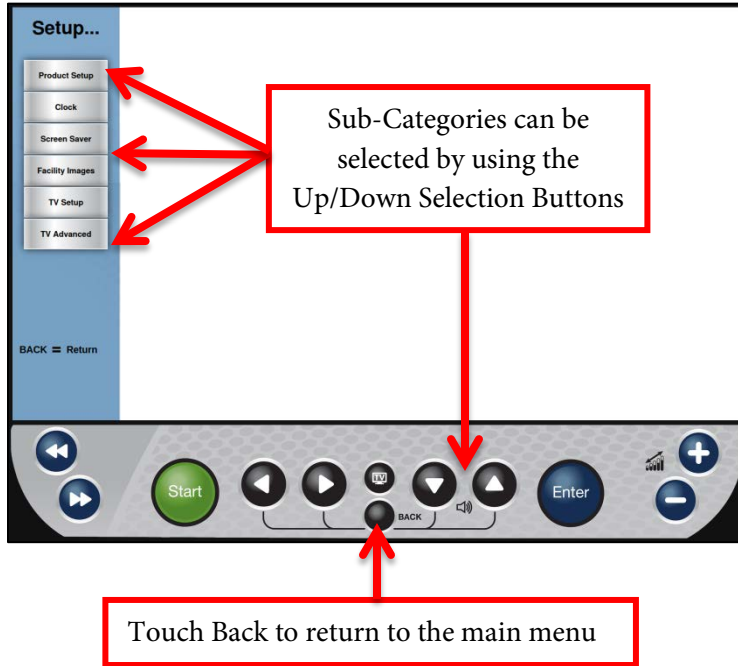

Setup Menu - Product Setup:

The Product Setup screen allows users to change the console configuration to match the unit on which it is installed. To change the console configuration:

- From the Main Menu, select the Setup menu.
- From the Setup Menu, select Product Setup (A).
- Use the Selection Buttons (B) to select the correct model number (C).
- Press the Enter Button (D) to confirm the selection.

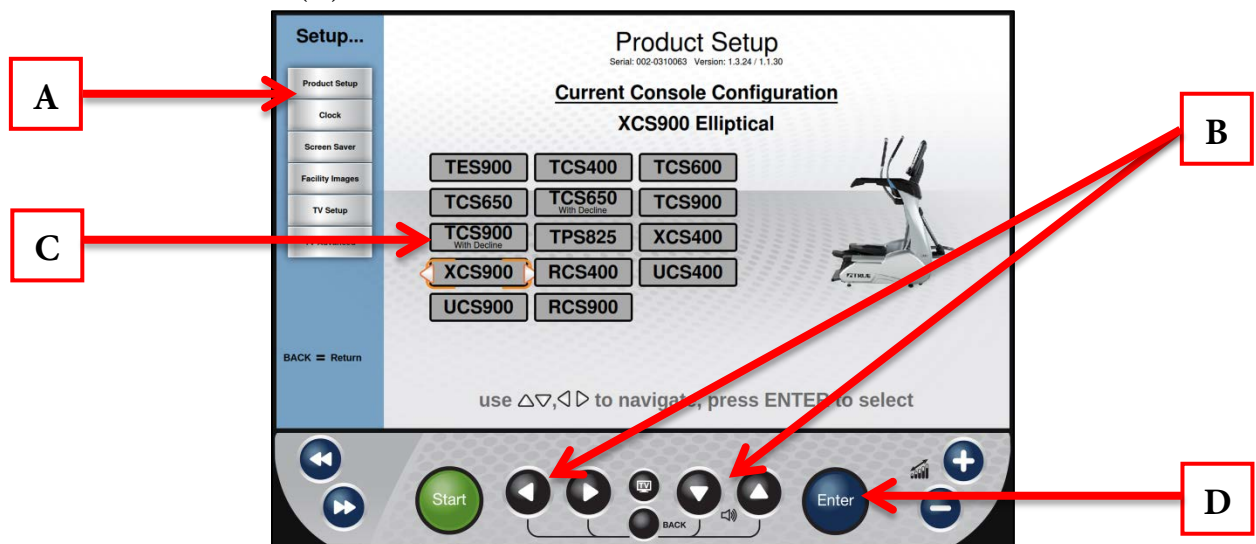

*Note: The Product Setup screen will only display the specific product that the console is currently located on. The above image shows all available options only for reference.

CHAPTER 4B: ESCALATE¹⁵ OPERATION

ADVANCED CONSOLE FUNCTIONS (CONTINUED):

Setup Menu - Clock:

Correctly setting up the clock will ensure that all workout data that is exported by a user will be correctly labeled. Correct time is also important for troubleshooting purposes when viewing the system's fault log.

Setting the Clock:

- From the Main Menu, select the Setup menu.
- From the Setup Menu, select Clock (A).
- Use the Left/Right Selection Buttons (B) to select the desired value (C).
- Use the Up/Down Selection Buttons (D) to adjust the value to the desired setting.
- Once the correct time and date are entered, select Next (E) and press Enter (F).

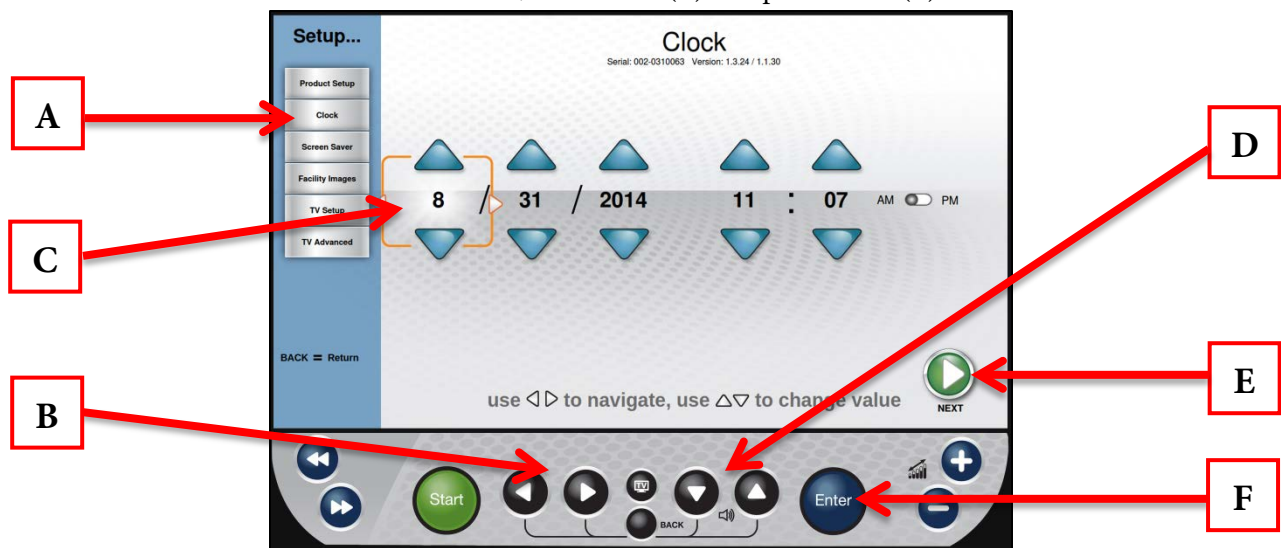

- Use the Up/Down Selection Buttons (G) to scroll through the list of time zones until the correct time zone is shown in bold (H).
- Use the Right Selection Button (I) to highlight Save (J) and press Enter (K).

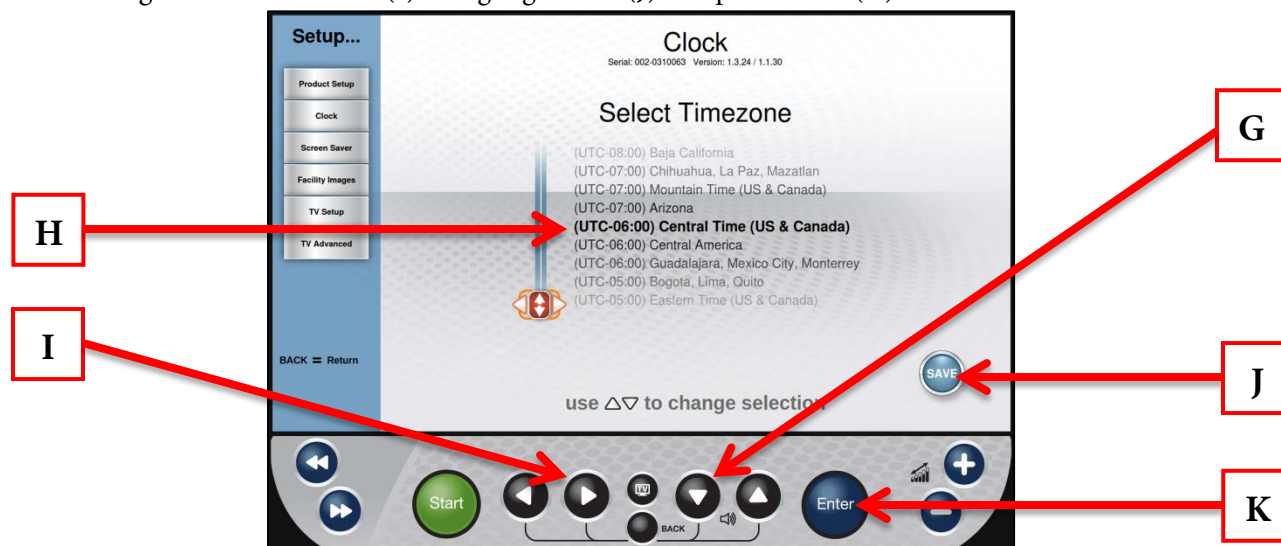

CHAPTER 4B: ESCALATE¹⁵ OPERATION

ADVANCED CONSOLE FUNCTIONS (CONTINUED):

Setup Menu - Screen Saver:

Users can load JPG images to be used by the console as a custom screen saver. In order to be uploaded to the console, images will need to be placed on a USB drive in a folder named “screen saver” (case sensitive).

Importing Screen Saver Images:

- Select Screen Saver (A) from the Setup Menu and press Enter (B).
- Insert the USB drive that contains the images into the console’s USB port.
- Verify the images in the preview window (C)
- Select Save (D) and press Enter (B) to save the images to the console.



Additional Screen Saver Options:

- Custom Screen Saver images can be deleted by selecting Clear Current Slides (E) and pressing Enter (B).
- The amount of time the console must be idle before the screen saver engages can be adjusted by selecting Screen Saver Time (F) and using the Left/Right Navigation buttons (G) to select the desired time.
- The Sleep timer is a function that will turn off the console’s back light after a period of time to save energy. The amount of time the console must be idle before going to sleep can be adjusted by selecting the Sleep Timer (H) and using the Left/Right Selection Buttons to select the desired time.

⚠️ WARNING:

Setting the Screen Saver Time to zero will disable the screen saver. Disabling the screen saver is not recommended! Doing so may cause damage to the screen and void the manufacturer warranty.

CHAPTER 4B: ESCALATE¹⁵ OPERATION

ADVANCED CONSOLE FUNCTIONS (CONTINUED):

Setup Menu - Facility Images:

The Escalate¹⁵ console supports customizable facility images to help promote specials, events or endorse a brand. In order to be uploaded to the console, images will need to be placed on a USB drive in a folder named “facility” (case sensitive).

Importing Facility Images:

- Select Facility Images (A) and press Enter (B).
- Insert the USB drive that contains the images into the console’s USB port.
- Verify the images in the preview window (C)
- Select Save (D) using the Up/Down Selection Buttons (E) and press Enter (B) to save the images to the console.



* Facility images can be deleted by selecting the Clear (F) and pressing Enter (B).

Once loaded correctly, the facility Images will be displayed in the Facility Workout Data Screen (as shown below).

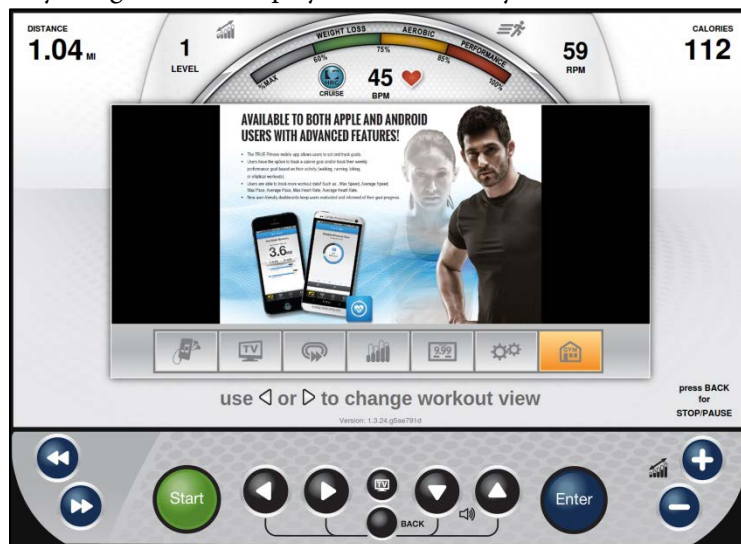

CHAPTER 4B: ESCALATE¹⁵ OPERATION

ADVANCED CONSOLE FUNCTIONS (CONTINUED):

Setup Menu - TV Setup:

Escalate¹⁵ consoles have an integrated HDTV Tuner which allows the user to watch live programming in crisp, clear high Definition. Before any programming can be viewed, the TV signal needs to be set up. (TV Options will not be displayed on the Home Screen or in the Workout Data Screens until the TV Setup Steps have been completed)

TV Setup Steps:

- From the Setup Menu, select TV Setup (A) and press Enter (D).
- Use the Up/Down Selection Buttons (B) to highlight the type of signal is being used (C). Then press Enter (D) to select the appropriate signal type; Analog, Digital, or Both. (Digital is selected by default)
*When analog is selected the user will need to choose the analog standard (NTSC-M for the United States).
- Highlight the Source Slider (E) and Press Enter (D) to toggle between Antenna and Cable.
- Verify that the correct Country is listed (F).
- Highlight Enable Aux Input (G) and press Enter (D) to Enable or disable the AUX inputs located on the back of the console.
- Highlight Begin Channel Scan (H) and press Enter (D) to begin scanning for channels.



- Once the channel scan is complete, the channel list (I) will be populated with the available channels.

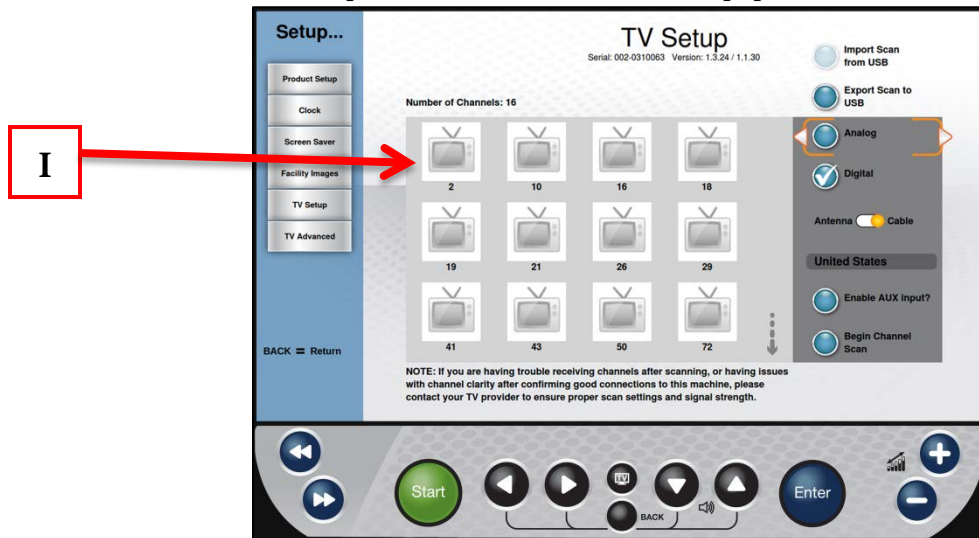

CHAPTER 4B: ESCALATE¹⁵ OPERATION

ADVANCED CONSOLE FUNCTIONS (CONTINUED):

Setup Menu - TV Setup (continued):

Users can save time when setting up multiple units or maintain a back-up of their TV Setup Data by exporting it to a USB drive.

Exporting TV Setup Data to USB:

- Complete the TV Setup process.
- Insert a blank USB drive into the console's USB port.
- When all desired channels are listed in the Channel List (A), use the Up/Down Selection Buttons (B) to highlight Export Scan to USB(C) and press Enter (D).

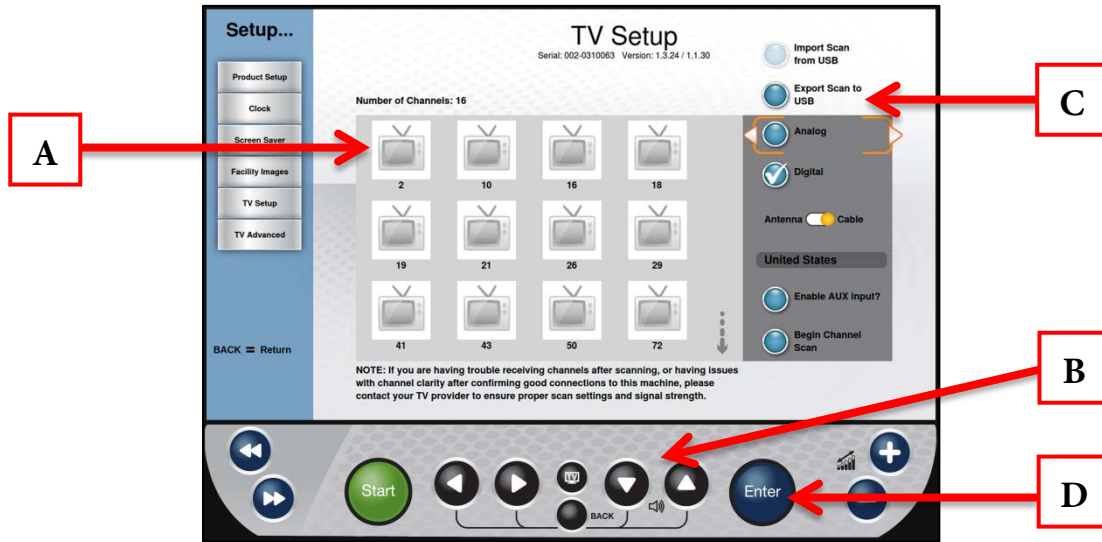

Importing TV Setup Data from USB:

- Navigate to the TV Setup screen.
- Insert the prepared USB stick into the console's USB Port.
- Highlight Import Scan from USB (A) using the UP/Down Selection Buttons (B) and press Enter (C).
- Once the import process is complete, verify that all channels are listed in the channel list (D).



CHAPTER 4B: ESCALATE¹⁵ OPERATION

ADVANCED CONSOLE FUNCTIONS (CONTINUED):

Setup Menu - TV Advanced:

The TV Advanced Menu allows users to fine tune their TV settings by adding channels, removing channels, and adding channel logos.

Add a Channel:

- Navigate to the TV Advanced Screen (A).
- Press the Forward Navigation Button (B) to access the Add Channel Screen.
- Use the Left Right Navigation Buttons(C) to select between the available values (Standard, Frequency, Network, and Channel Number). *Channel frequencies must be obtained from your television service provider.
- Use the Up/Down Selection buttons (D) to adjust each value.
- Once all values are correct, press Enter (E) to save the channel

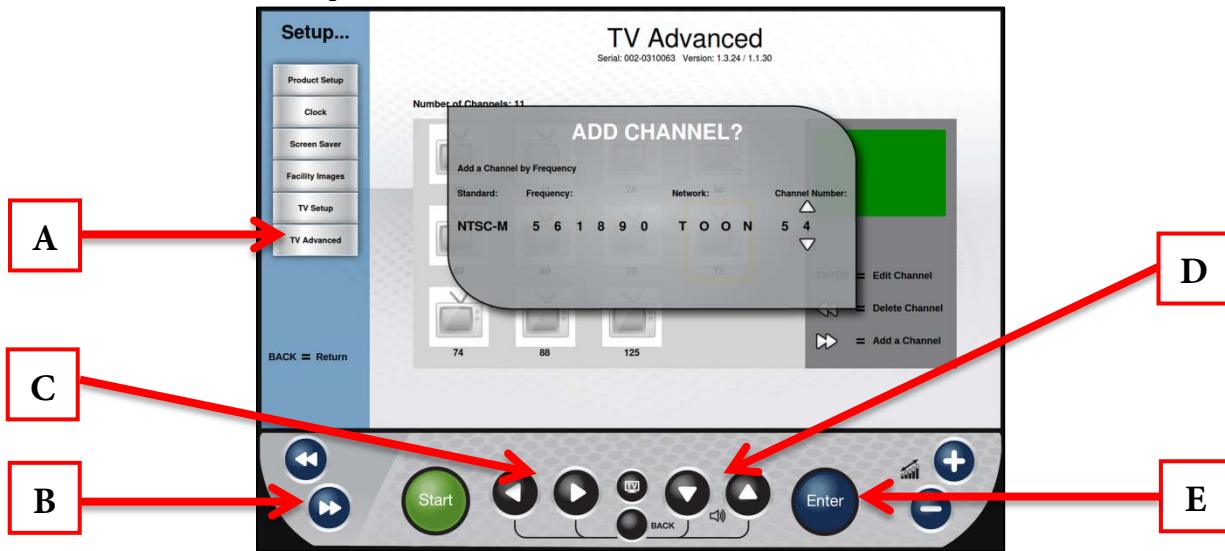

Deleting Channels:

- Highlight the channel to be deleted.
- Press the Back Navigation Button (A)
- Press Enter (B) to delete the selected channel or the forward navigation button (C) to delete all channels



CHAPTER 4B: ESCALATE¹⁵ OPERATION

ADVANCED CONSOLE FUNCTIONS (CONTINUED):

Setup Menu - TV Advanced (continued):

Using Channel logos allows users to quickly identify and select their favorite TV channels with minimal interruption to their workout.

Adding Channel Logos:

- Navigate to the TV Advanced Screen (A).
- Select the desired channel in the Channel List (B) and press the Enter Button (C).



- Select the logo (D) that corresponds to the selected channel and press Enter (C) to save.
- Repeat these steps for each channel for which a logo is available.



CHAPTER 4B: ESCALATE¹⁵ OPERATION

ADVANCED CONSOLE FUNCTIONS (CONTINUED):

Options Menu:

The Options menu allows users to customize settings on the console to meet their needs. Use the Up/Down Selection Buttons (A) to select the desired option and the Left/Right Selection Buttons (B) to adjust the value.

*The settings in this menu save automatically.

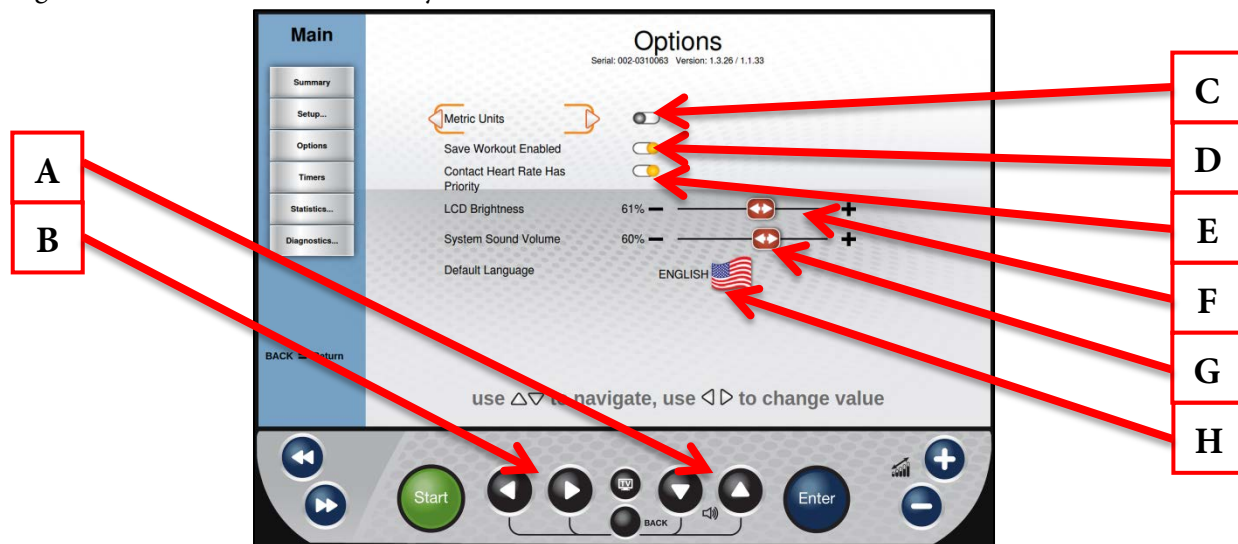

C) Metric Units:

When enabled, the console will display all Metric units rather than American Standard.

D) Save Workout Enabled:

Turn on this feature to allow users to save custom workouts to the console.

E) Contact Heart Rate Has Priority:

When enabled, the console will attempt to read heart rate data from the contact heart rate grips before reading data from a wireless chest strap.

*When this option is turned off, telemetry heart rate will take priority.

F) LCD Brightness:

Adjusts the brightness of the TFT display.

G) System Sound Volume:

Adjusts the volume of the notifications and beeps that come from the console.

H) Default Language:

Select a different language. Once a new default language has been selected, all menus, options and workout data will appear in that language.

CHAPTER 4B: ESCALATE¹⁵ OPERATION

ADVANCED CONSOLE FUNCTIONS (CONTINUED):

Timers Menu:

The Timers Menu allows for time limits to be set on various console features and functions. Use the Up/Down Selection Buttons (A) to select the desired option and the Left/Right Selection Buttons (B) to adjust the value.

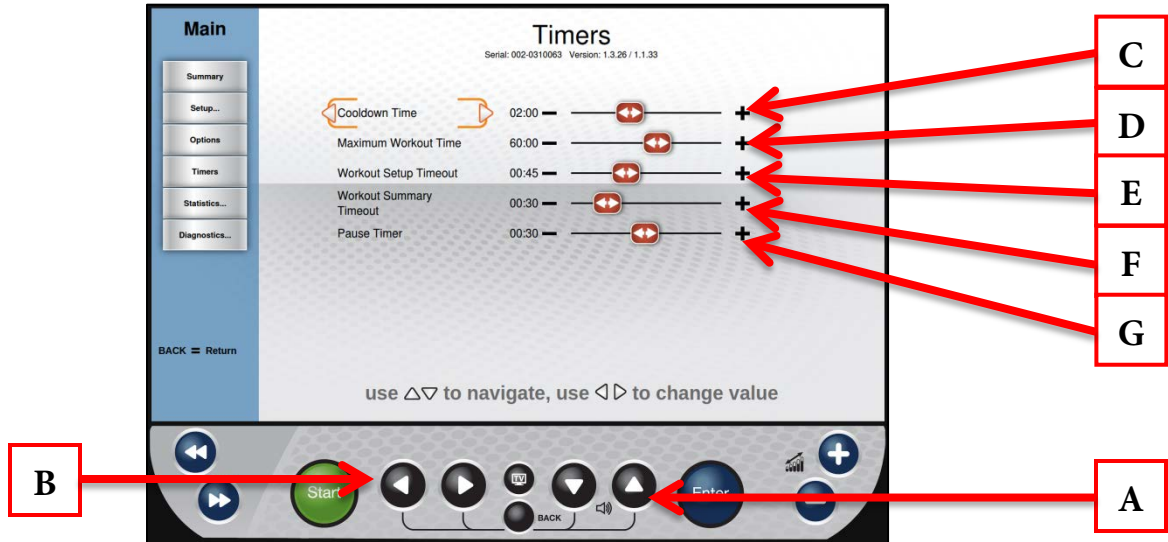

C) Cooldown Time:

Adjusts the length of the cooldown segment at the end of a workout.

D) Maximum Workout Time:

This setting will limit the amount of time that all workouts can last (this setting does not apply to quickstart workouts, manual workouts or distance workouts).

E) Workout Setup Timeout:

Choose how long the workout data entry screen will remain on the display without any user interaction. By choosing the “off” setting, the data entry screen will be displayed until closed by a user.

F) Workout Summary Timeout:

Determines the amount of time the Workout Summary Screen will remain on the display. By choosing the “Off” setting, the summary will be displayed until ended by a user.

G) Pause Timer:

This setting will limit the amount of time that a workout can be paused before it automatically ends. By choosing the “Off” option, the unit will remain paused until the user resumes or ends the workout.

CHAPTER 4B: ESCALATE¹⁵ OPERATION

ADVANCED CONSOLE FUNCTIONS (CONTINUED):

Statistics Menu:

The statistics menu provides an overview of how and how long the unit has been used.

Statistics Menu – Summary:

Selecting the Summary screen (A) will provide a usage summary. Run Hours (B) is the total number of hours the unit has been used. Machine Distance (C) is the total distance in miles that the belt has traveled. Distance (D) is the amount of distance the belt has traveled since the last time the Clear Mileage (E) feature was used.

*The Distance/Clear Mileage feature is helpful for tracking mileage in a preventive maintenance schedule.

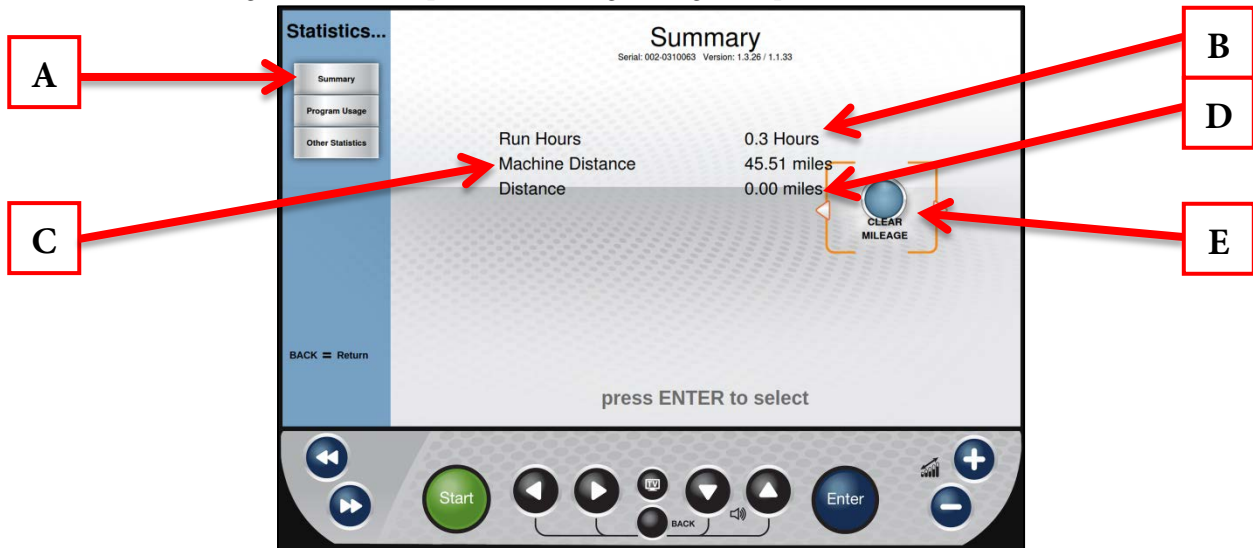

Statistics Menu – Program Usage:

Selecting the Program Usage screen (A) will provide a list of programs that have been used on the unit and how many times those programs have been used. These statistics can be reset by highlighting the Clear button (B) and Pressing Enter (C), but it is not recommended.

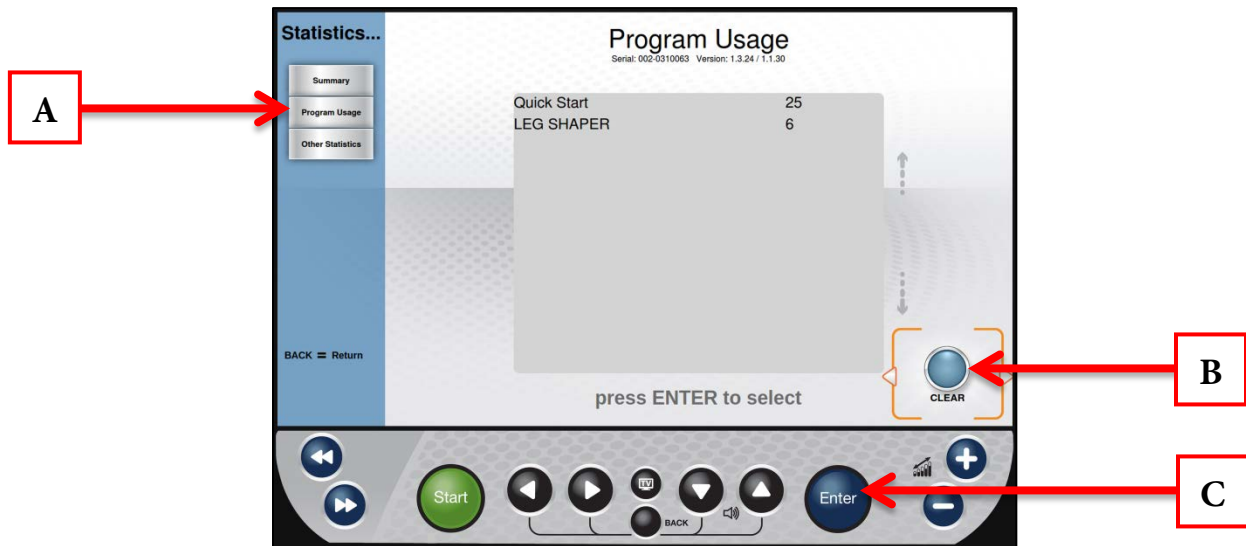

CHAPTER 4B: ESCALATE¹⁵ OPERATION

ADVANCED CONSOLE FUNCTIONS (CONTINUED):

Diagnostics Menu:

The Diagnostics Menu contains tools used to help diagnose errors and performance issues.

Diagnostics Menu-Tests:

The Tests Screen is used by technicians to aid in troubleshooting and contains commonly used troubleshooting tests.

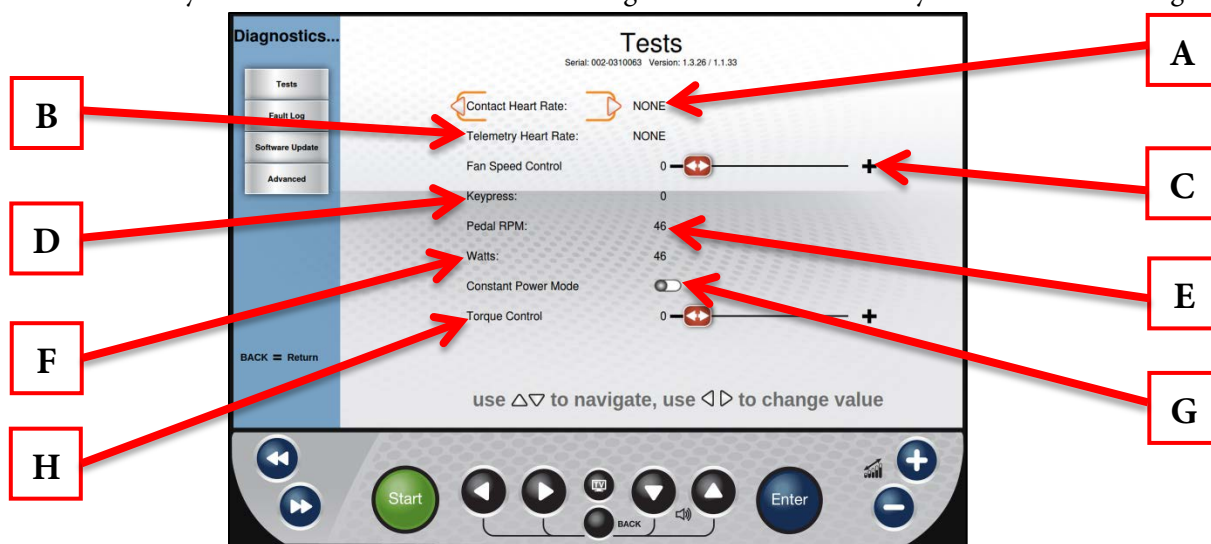

A) Contact Heart Rate:

Ensures the unit is receiving the data by displaying the user's heart rate when the contact heart rate pads are gripped.

B) Telemetry Heart Rate:

Use a wireless heart rate strap or simulator to test if the unit is receiving wireless heart rate data. If there is a reading displayed without the use of a heart rate strap or simulator, there is outside interference from another source.

*This unit is designed to receive 5 khz non-coded transmissions only.

C) Fan Speed Control:

Allows users to test the fan independent of a program.

D) Keypress:

When a quick access key is pressed on the unit, "NONE" will change to indicate which key is being pressed. In the event of a stuck key, the key that is being engaged will display.

E) Pedal RPM:

While a user is pedaling this value will display the current RPM for testing purposes.

F) Watts:

While a user is pedaling this value will display the current watts for testing purposes.

G) Constant Power Mode:

A diagnostic brake test. *This setting should only be enabled by a TRUE Technical Support Representative.

H) Torque Control:

Manually Increases or decreases the resistance level, independent from a program to test brake function.

CHAPTER 4B: ESCALATE¹⁵ OPERATION

ADVANCED CONSOLE FUNCTIONS (CONTINUED):

Diagnostics Menu - Fault Log:

The Fault Log (A) will display a time stamped list of recent fault codes that can be helpful in the troubleshooting process. The Fault Log can be exported to a USB drive by highlighting Export (B) and pressing Enter (C). The log can also be reset by highlighting Clear (D) and pressing Enter (C), but it is not recommended.

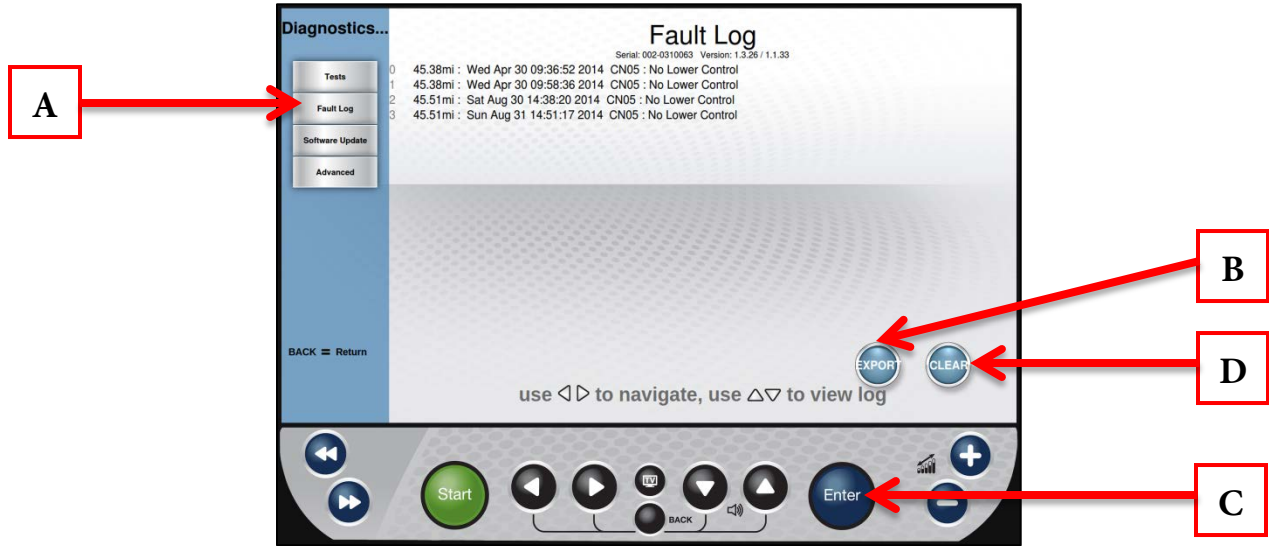

Diagnostics Menu - Software Update:

TRUE may periodically release software updates to ensure users enjoy the best workout experience available. To update the console software, download the update program (A) from truefitness.com and load the software to a blank USB drive by following the downloadable instructions.

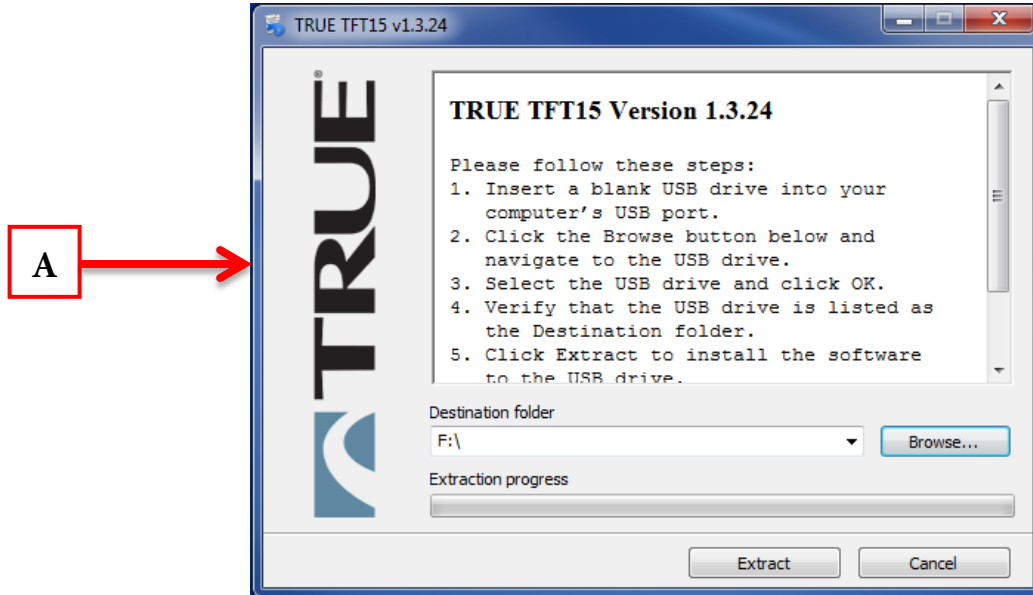

⚠️ WARNING:

Disconnecting the power source, switching the unit off or pressing buttons on the console will disrupt the information flow and potentially cause fatal errors.

CHAPTER 4B: ESCALATE¹⁵ OPERATION

ADVANCED CONSOLE FUNCTIONS (CONTINUED):

Diagnostics Menu - Software Update (continued):

- Insert the USB drive containing the software update into the console's USB port.
- From the Diagnostics Menu, use the Up/Down Selection Buttons to highlight Software Update and press the Enter Button (A).
- When the console locates the software update, highlight Update Software (B) and press Enter.

NOTE: Do not power cycle the unit between the software and firmware updates

- After the installation of the software update, highlight Load Firmware (C) and press Enter.
- Following the installation of the software and firmware, power cycle the unit to finalize the software update.

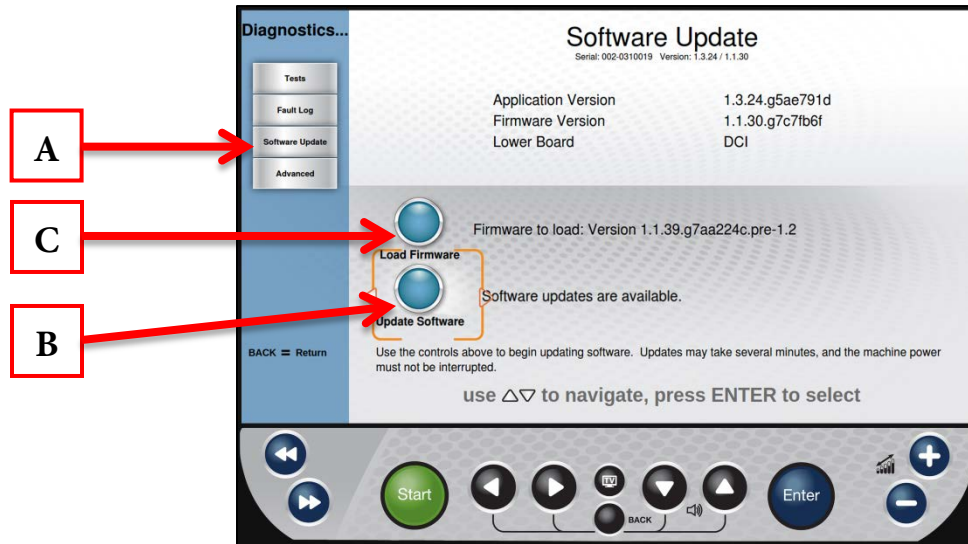

Diagnostics Menu - Advanced:

The advanced screen contains multiple tools that are used in the production of the console and for demonstration purposes. It is recommended to leave these settings in their default positions.

CHAPTER 4C: ESCALATE⁹ OPERATION

ESCALATE⁹ OVERVIEW:



CHAPTER 4C: ESCALATE⁹ OPERATION

ESCALATE⁹ OVERVIEW (CONTINUED):

TFT Display:

Used to monitor or control a workout and feature navigation.

Selection Buttons:

Used to navigate menus and make selections via the TFT Display.

Workload Keys:

Manually increases or decreases the workout intensity.

Start:

Allows the user to begin a Quick Start workout or preset workout.

Reading Rack:

A ledge on the console can be used to hold a book, magazine, e-reader, or tablet computer during a workout.

USB Port:

Allows users to export workout data to an external USB drive or update the console software.

Numeric Keypad:

A small panel of keys on the console that allow the user to quickly enter numeric data.

Headphone Jack:

Standard 3.5mm audio jack used to connect headphones to the console during media playback.

Warning Decal:

Important safety information for users to review prior to using the equipment.

Stop:

Stops/Pauses a workout. Press and hold this key for five seconds to reset the unit.

CHAPTER 4C: ESCALATE⁹ OPERATION

CONSOLE NAVIGATION:

Home Screen:

The Home Screen is displayed on the console when there is no workout in progress. From this screen the user is able to select from various options to begin a workout.



A) Cardio 360™ Quick Start

Starts a 20 minute Cardio 360™ workout in which the user controls the workout intensity.

B) Workout Finder

Displays preset workouts categorized by goal focus categories.

C) Quick Start

Starts a Quick Start workout in which the user controls all settings until the workout is ended by pressing Stop or Cool Down.

D) Language Options

Allows users to choose between 12 language options.

CHAPTER 4C: ESCALATE⁹ OPERATION

CONSOLE NAVIGATION (CONTINUED):

Selecting a Preset Workout:

Preset workouts are accessed by selecting Workout Finder from the home screen. To view the workouts in a category, select the category (A) by using the Scroll Selection Buttons (B) and then press the Next Selection Button (C).

*Press and hold the Next Selection Button to return to the previous screen.



Workout Data Entry Screens:

These screens allow users to input their personal information or workout goals prior to beginning a workout. To set a value, press the Selection Button for the value you wish to change (A) and use the Workload Keys (B) to adjust the value to the desired setting. Users may also manually enter a value using the Numeric Keypad (C).

*Workout Data Entry Screens vary by program selection.

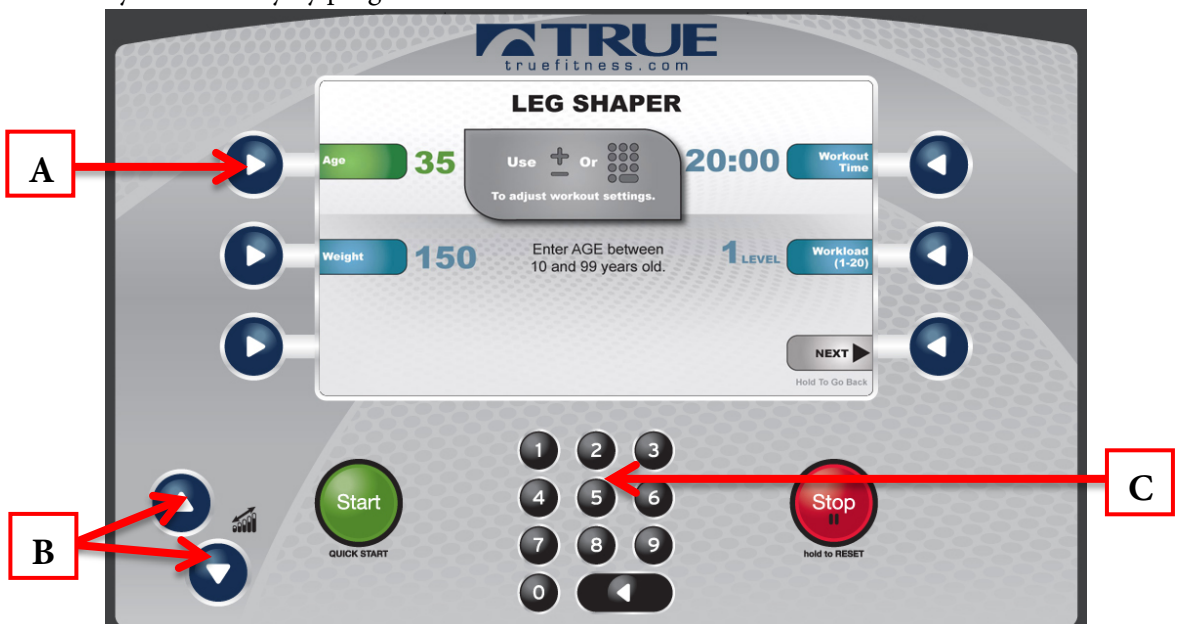

CHAPTER 4C: ESCALATE⁹ OPERATION

CONSOLE NAVIGATION (CONTINUED):

Workout Data Screens:

During any workout a Workout Data Screen will be displayed to give the user a comprehensive visual overview of their current workout data.

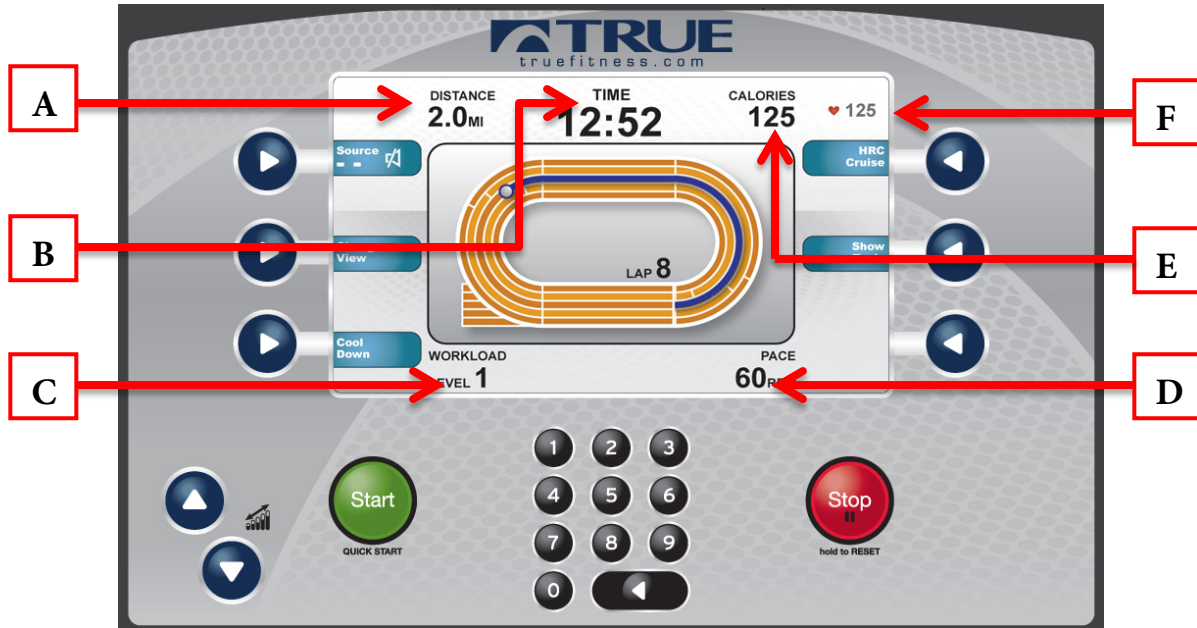

A) Custom Data Display #1:

By Default, this display will show the distance for the current workout. Users can also choose custom data points to be seen in this display.

*See Workout Data Screen Controls; E) Show Tools section below.

B) Time:

Displays the time elapsed for the current workout.

C) Workload:

Shows the current workload level.

D) Pace:

Displays the current pace of a workout.

E) Custom Data Display #2:

By Default, this display will show the calorie count for the current workout. Users can also choose custom data points to be seen in this display.

*See Workout Data Screen Controls; E) Show Tools section below.

F) Heart Rate:

Shows the user's heart rate in a digital beats per minute (bpm) readout.

CHAPTER 4C: ESCALATE⁹ OPERATION

CONSOLE NAVIGATION (CONTINUED):

Workout Data Screen Controls:

The Workout Data Screens contain various controls that allow users to adjust workout settings and to customize their overall workout experience. These controls are accessed by pressing the Selection Button for the control they wish to use.



A) Change View:

Switches between the available Workout Data Screens.

B) Cool Down:

Pressing this button allows the user to end their current workout with a two minute low intensity cool down period. When Cool Down is activated the unit is in manual mode and the user directly controls all settings.

C) HRC Cruise:

Engages Heart Rate Control to allow the equipment to maintain the user's current heart rate through automatic workload adjustments (when the user is utilizing heart rate monitoring).

CHAPTER 4C: ESCALATE⁹ OPERATION

CONSOLE NAVIGATION (CONTINUED):

D) Source:

Toggles between available audio sources which include TV (if your console is equipped with a Broadcast Vision receiver) and FM radio. When an audio source is selected the user is given control over volume (A), and channel adjustments (B).

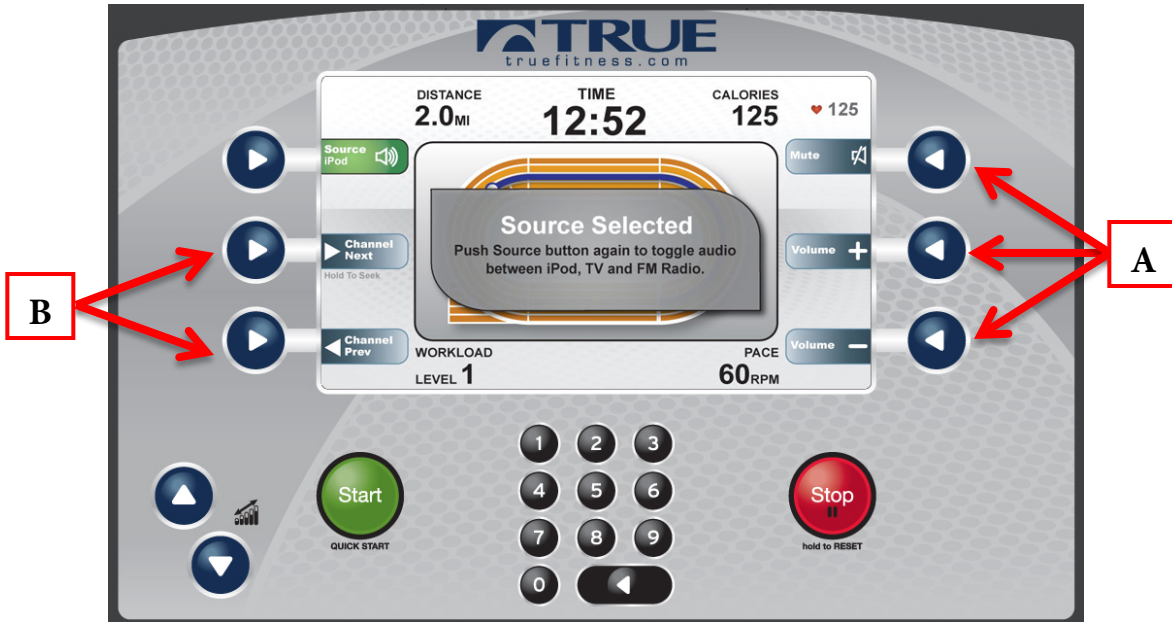

E) Show Tools:

Pressing the Show Tools Selection Button (A) will display various options. Pressing the Change Data Selection Button (C) will toggle the data points in Custom Data Display 1(1) between distance and watts. The data points in Custom Data display 2 (2) will toggle between calories and METs. Pressing the Scroll Data Selection button (B) will allow the Custom Data Displays to automatically toggle between data points. Pressing the Unit Selection Button (D) will change the units displayed between English and Metric.

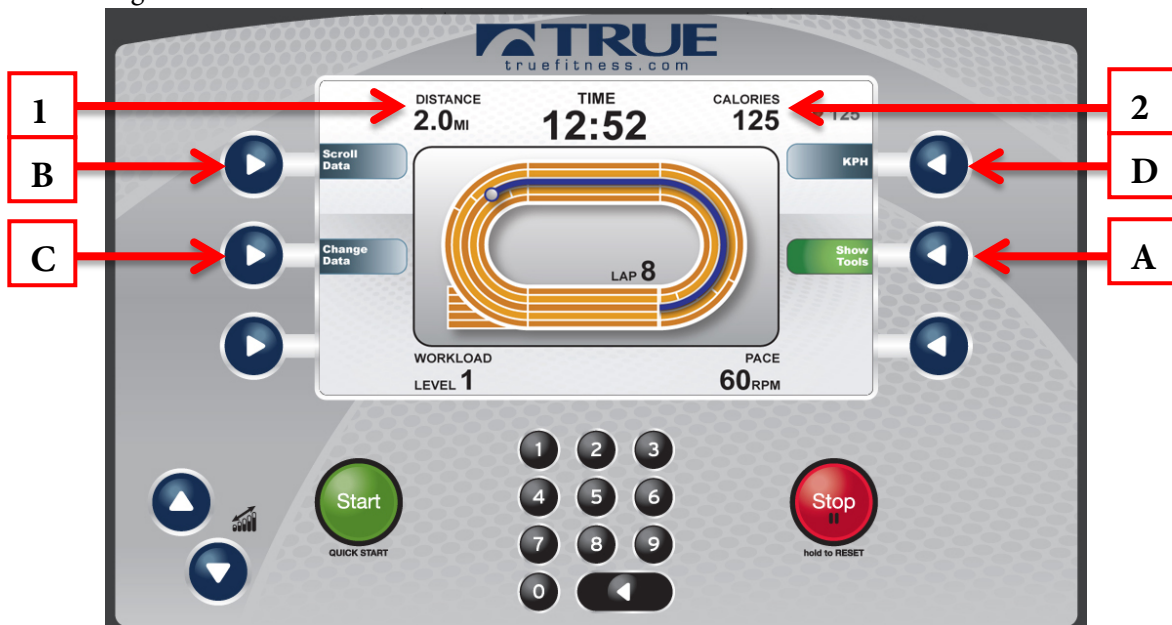

CHAPTER 4C: ESCALATE⁹ OPERATION

CONSOLE NAVIGATION (CONTINUED):

Cardio 360™:

TRUE's unique Cardio 360™ is like having a personal trainer built in to the elliptical, walking users through a full-body workout. In just minutes, users will work their upper-body, lower-body and core. Plus, with the variety that Cardio 360™ brings, it will take the bore out of working out. The program walks users through the various movements they need to do to achieve the complete workout, so all they need to do is commit to stepping on the machine.

During a Cardio 360™ program the Cardio 360™ Workout Data Screen will be displayed to guide users through the program.

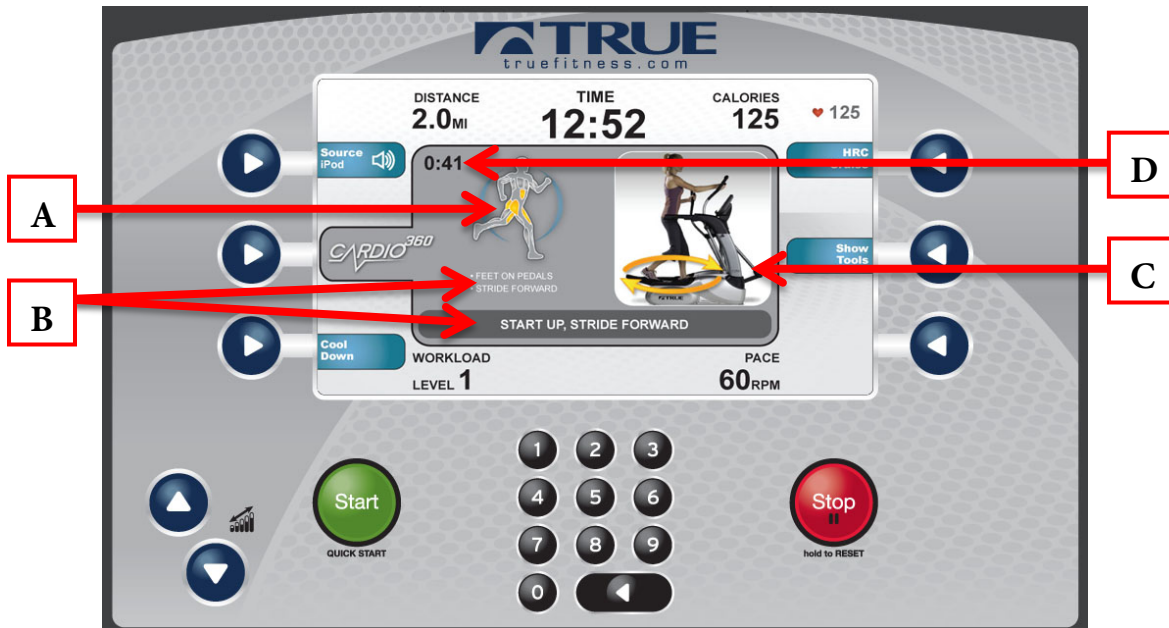

A) Target Display:

Highlights the muscle groups being targeted during the current workout segment.

B) Workout Directions:

Tells the user what actions to take during a workout segment.

C) Target Display:

Highlights the muscle groups being targeted during the current workout segment.

D) Segment Time Remaining:

Displays the time remaining in the current workout segment.

CHAPTER 4C: ESCALATE⁹ OPERATION

CONSOLE NAVIGATION (CONTINUED):

Workout Summary Screen:

At the end of a workout the Summary Screen will display an overview of the workout data. The workout data can be exported to another device by inserting a USB drive into the console's USB port and pressing the Save Selection Button (A) or to return to the home screen press the Home Selection Button (B)



CHAPTER 4C: ESCALATE⁹ OPERATION

ADVANCED CONSOLE FUNCTIONS:

Entering Service Mode:

Entering Service Mode can be completed by pressing and holding the upper left selection button (A) for 3-5 seconds or until the “Workout Finder” icon (B) blinks. When the “Workout Finder” icon blinks, release and hold the “Workout Finder” selection button (C) until the service screen displays.

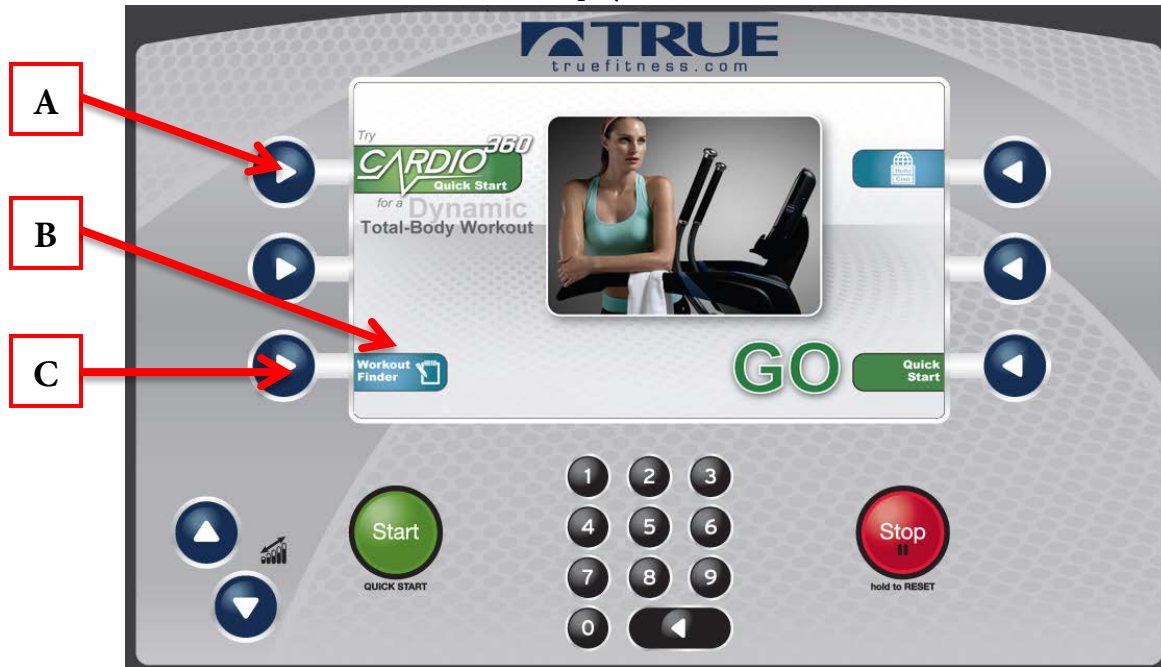

Service Menu:

The first screen displayed after entering service mode is the Service Menu. From this menu technicians can access all of the service mode features by selecting different categories. To select a category use the scroll selection buttons (A) to highlight a category (B). Once a category has been selected, press the enter selection button (C) to Confirm the selection.

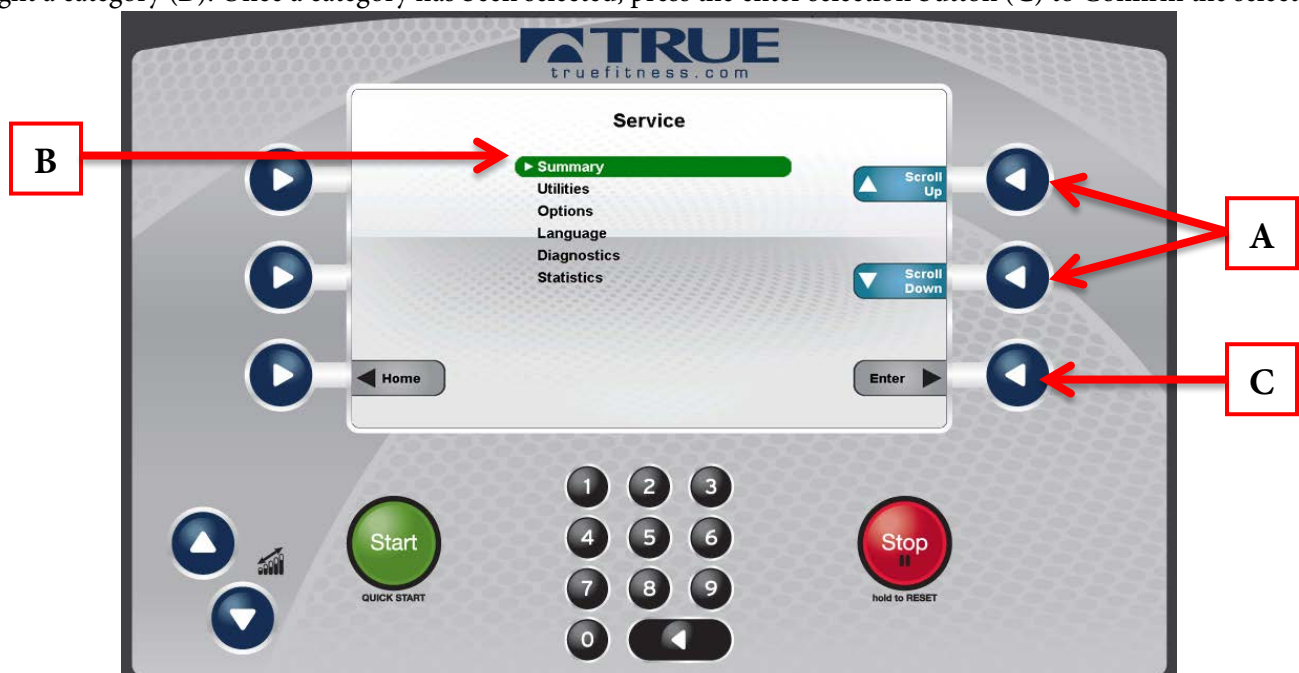

CHAPTER 4C: ESCALATE⁹ OPERATION

ADVANCED CONSOLE FUNCTIONS (CONTINUED):

Summary Screen:

The Summary Screen provides an overview of the unit's current settings (values cannot be changed in this screen).

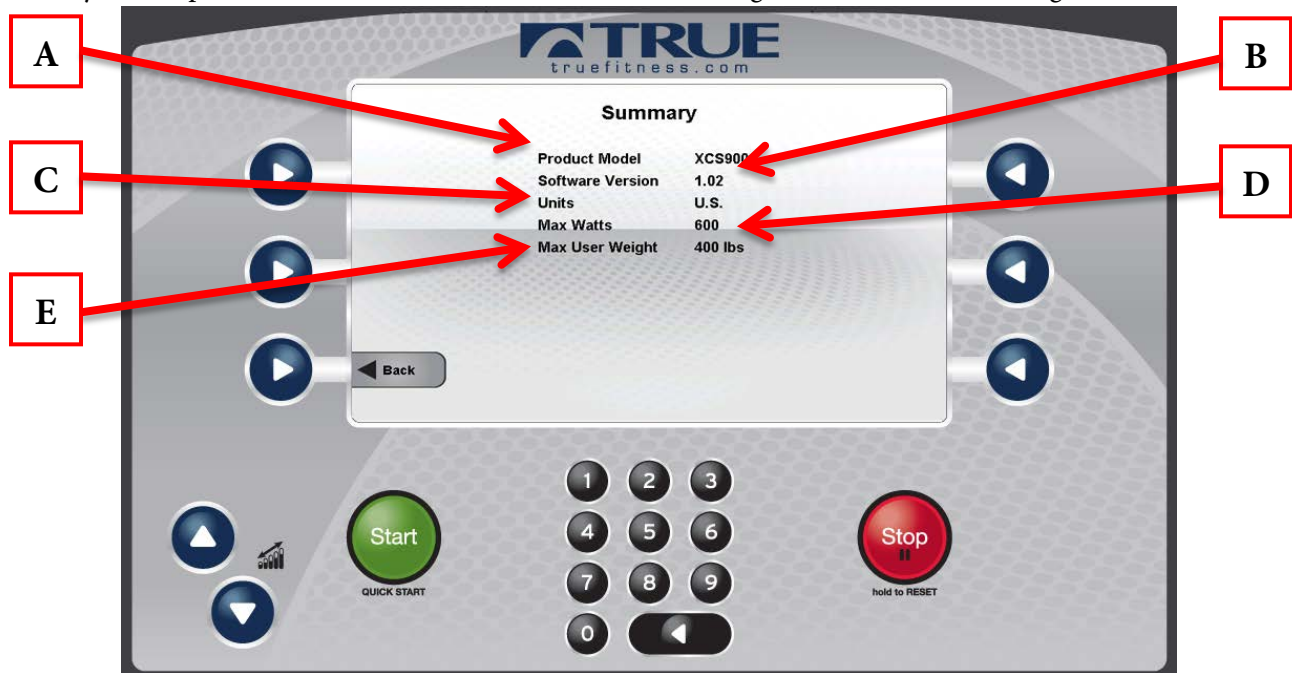

A) Product Model:

The model number that the console is currently configured to.

B) Software Version:

The current version of software that is installed on the console.

C) Units:

Displays the units the console is currently using as default (U.S. or Metric).

D) Max Watts:

Displays the maximum power the unit is capable of producing.

E) Max User Weight:

The amount of user weight that the unit can support.

CHAPTER 4C: ESCALATE⁹ OPERATION

ADVANCED CONSOLE FUNCTIONS (CONTINUED):

Utilities Menu:

The utilities menu contains multiple screens that allow the technician to change various console settings. Settings are broken down in to three categories. To adjust settings, highlight a category (A) by using the scroll selection buttons (B) and pressing the enter selection button (C) to confirm the selection.



Utilities Menu - Product Setup:

The product setup screen allows for adjustments to be made to the model configuration, TRUE's recommendation is to only use the Setup Wizard to adjust these attributes. After pressing the Setup Wizard Selection Button (A), simply follow the on screen instructions to complete the setup procedure

⚠️ WARNING:

Misconfiguration of the console may cause damage to the unit and void the manufacturer warranty. If necessary, please contact TRUE Fitness Technical Support at 800-883-8783 for assistance.

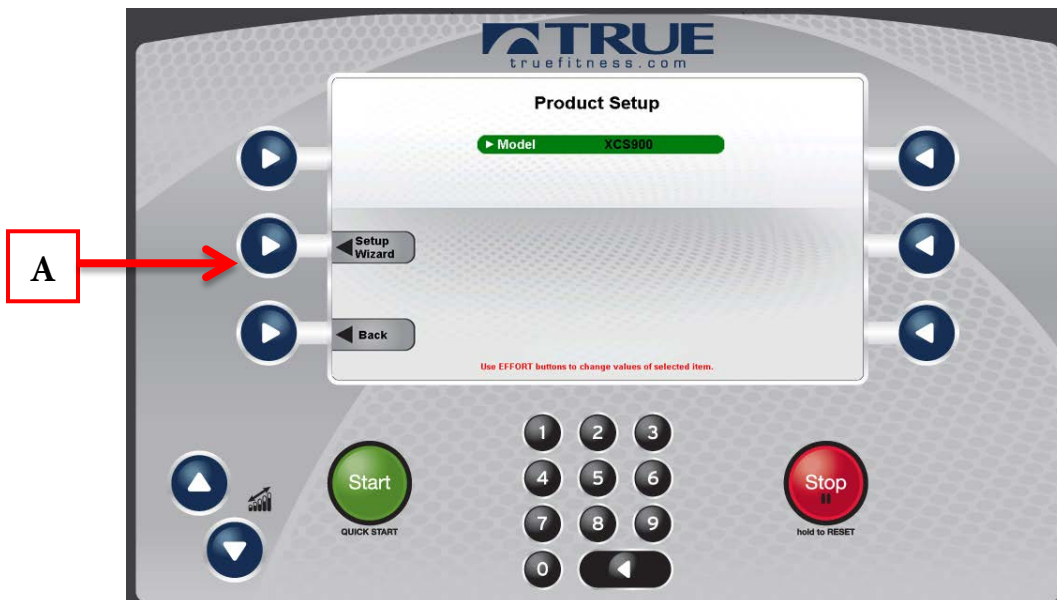

CHAPTER 4C: ESCALATE⁹ OPERATION

ADVANCED CONSOLE FUNCTIONS (CONTINUED):

Utilities Menu - Software Update:

TRUE may periodically release software updates to ensure users enjoy the best workout experience available. To update the console software, download the update program (A) from truefitness.com and load the software to a blank USB drive by following the downloadable instructions.

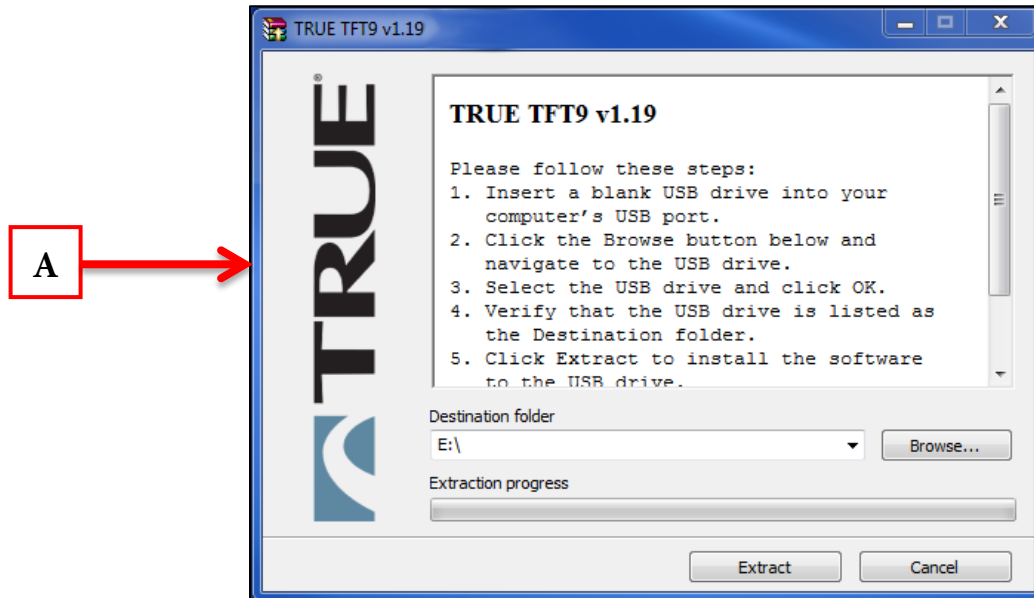

Navigate to the software update screen and insert the USB drive into the console's USB port. When the console recognizes the software it will show a message that reads "Drive found and ready. Press Update to begin. Warning: Improper use can render this machine inoperable". To complete the update, press the update selection button (A).



⚠️ WARNING:

Disconnecting the power source, switching the unit off or pressing buttons on the console will disrupt the information flow and potentially cause fatal errors.

CHAPTER 4C: ESCALATE⁹ OPERATION

ADVANCED CONSOLE FUNCTIONS (CONTINUED):

Utilities Menu - B-Vision Setup:

When equipped with the optional Broadcast Vision receiver, the Escalate⁹ console is capable of playing audio wirelessly from video sources that are equipped with a Broadcast Vision compatible wireless transmitter. To configure this feature, follow the steps below.

* Before beginning these steps, ensure that the audio source is connected to the wireless transmitter and both the source and the transmitter are powered on.

1. Use the Scroll Selection Buttons (A) to highlight the desired transmitter series from the list (BV TV SERIES 1-9) (B).

Broadcast Vision Transmitters	BV TV SERIES 2
Mye [®] and Fantaay [®] Transmitters	BV TV SERIES 4
Cardio Theater [®] LCS Transmitters	BV TV SERIES 8
Cardio Theater [®] xTV Transmitters	BV TV SERIES 9

NOTE: The Escalate⁹ console is designed to work with Broadcast Vision transmitters. There may be compatibility issues if a non-Broadcast Vision transmitter is used.

2. Press the Select Selection Button(C) to confirm the BV TV SERIES selection.

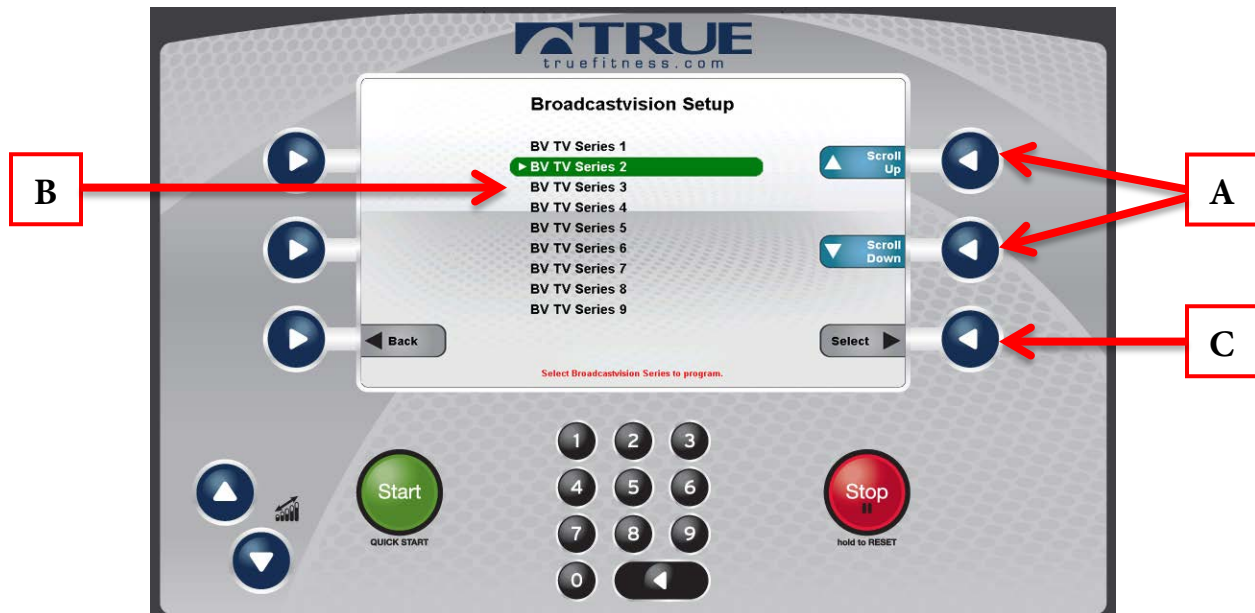

CHAPTER 4C: ESCALATE⁹ OPERATION

ADVANCED CONSOLE FUNCTIONS (CONTINUED):

Utilities Menu - B-Vision Setup (continued):

3. Plug headphones into the headphone jack on the console and wear them for the remaining steps.
4. Use the Channel Selection Buttons (**D**) to scroll through the available channels.
5. When audio is clearly heard on a channel, push the Save Selection Button (**E**) to save the channel.

NOTE: The order in which the channels are saved determines the order that they are displayed in standard user mode.

6. Repeat steps 4 and 5 for each additional audio source.
7. If a channel needs to be removed, use the Channel Selection Buttons (**D**) to scroll to the channel and press the Unsave Selection button (**F**)
8. Once all desired channels are saved, press the Exit Selection Button (**G**) to exit the BV-Setup.

* During the channel setup, the + and - Workload Keys (**H**) can be used to adjust the volume level.



CHAPTER 4C: ESCALATE⁹ OPERATION

ADVANCED CONSOLE FUNCTIONS (CONTINUED):

Options Menu:

The options menu contains 12 Settings with various options available for each. To navigate the options menu, use the scroll selection buttons (A) to highlight the option to be changed (B) and use the Workload keys (C) to adjust the options. Once the changes are complete, press the back selection button (D) and the changes will be automatically saved.



Language:

Select a default Language for the unit. All settings and workout data will be displayed in that language.

Units:

Choose how the workout data is displayed by default.

Save Workout:

Turns the saved workout feature on or off.

Heart Rate Priority:

Determines the order in which the unit reads heart rate data.

Cooldown:

Adjusts the length of the cooldown time at the end of a workout.

Sleep Mode Time:

The amount of time the unit can be idle before entering sleep mode. By choosing the "Off" setting, the unit will remain powered.

CHAPTER 4C: ESCALATE⁹ OPERATION

ADVANCED CONSOLE FUNCTIONS (CONTINUED):

Options Menu (continued):

Max Workout Time:

This setting will limit the amount of time that all workouts can last. By choosing the “Off” setting, the time will be unlimited (this setting does not apply to manual workouts or distance workouts).

Finder Timeout:

Choose how long the Workout Finder remains on the screen without any user interaction. By choosing off, the Workout finder will stay open until closed by a user.

Setup Timeout:

Choose how long the workout data entry screen will remain on the display without any user interaction. By choosing the “off” setting, the data entry screen will be displayed until closed by a user

Summary Timeout:

Determines the amount of time the Workout Summary Screen will remain on the display. By choosing the “Off” setting, the summary will be displayed until ended by a user.

Pause Time:

This setting will limit the amount of time that a workout can be paused before it automatically ends. By choosing the “Off” option, the unit will remain paused until the user resumes or ends the workout.

Factory Defaults:

Resets all settings in the options menu to factory defaults.

Diagnostics Menu:

The diagnostics menu contains tools used to help diagnose errors and performance issues. The tools are broken down into three categories. To use a tool, highlight a category (A) by using the scroll selection buttons (B) and pressing the enter selection button (C) to confirm the selection.

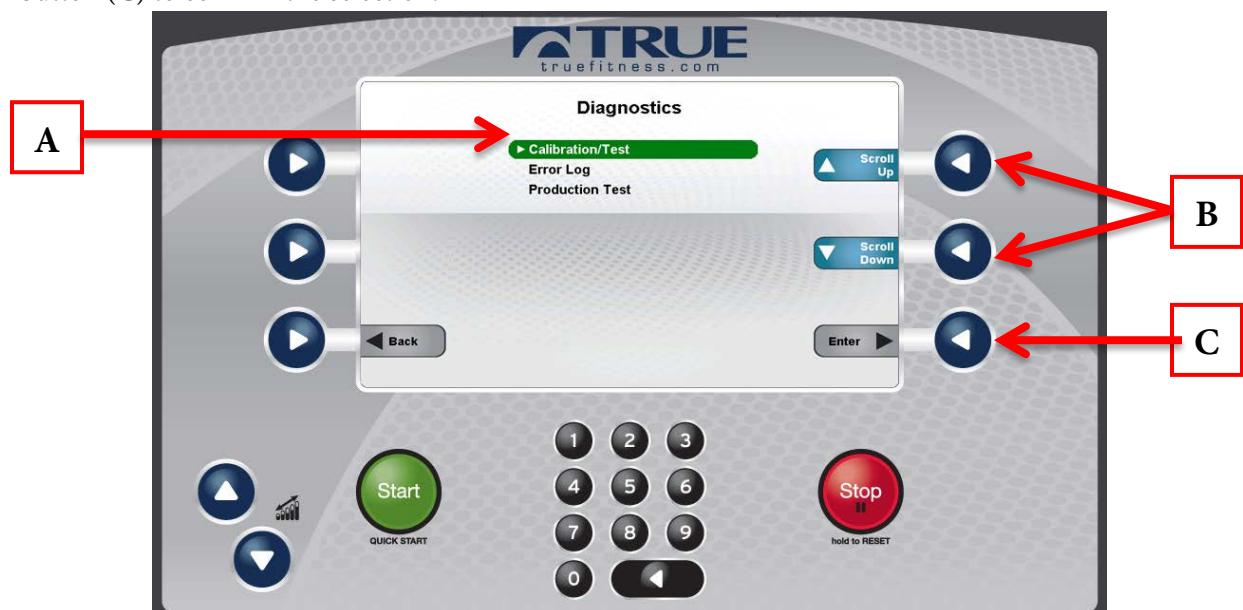

CHAPTER 4C: ESCALATE⁹ OPERATION

ADVANCED CONSOLE FUNCTIONS (CONTINUED):

Diagnostics Menu - Calibration/Test & Production Test:

These menus are currently not used on bikes or ellipticals.

Diagnostics Menu - Error Log:

Error codes are an important part of troubleshooting any issues with the unit. Any time an error occurs it is entered into the error log for review by a service professional. This console is capable of storing the ten most recent errors. The error log can be cleared by pressing the enter selection button (A), but it is not recommended.

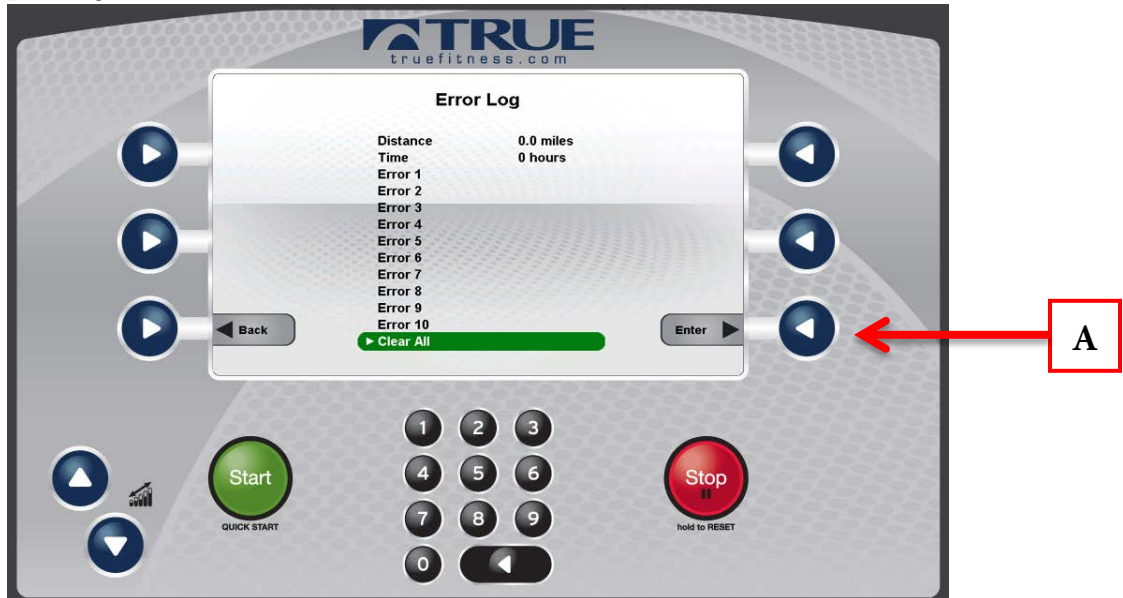

Statistics:

An overview that includes distance, time, manual program count, preset program count, and apple device connections. These statistics can be exported to a connected USB drive by using the scroll selection buttons (A) to highlight the USB Export option (B) and pressing the enter selection button (C). The data can be cleared by selecting Clr Dist/Time/Spd (D) or Clr Man/Prog/Apple (E), but it is not recommended.

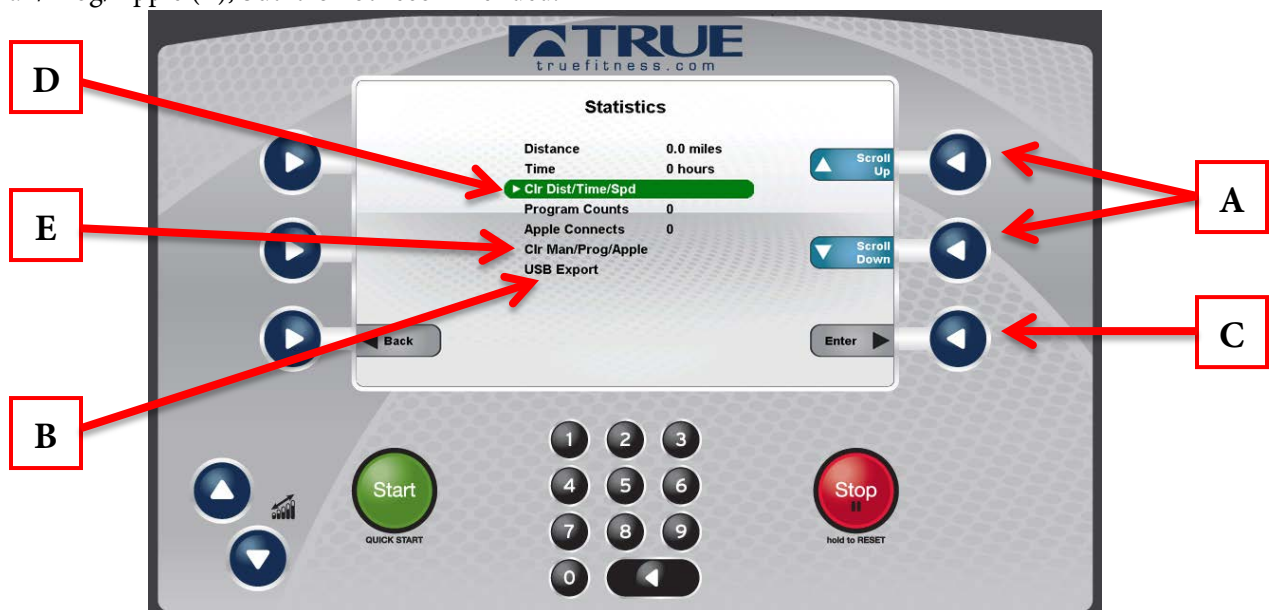

CHAPTER 4D: EMERGE OPERATION

EMERGE OVERVIEW:

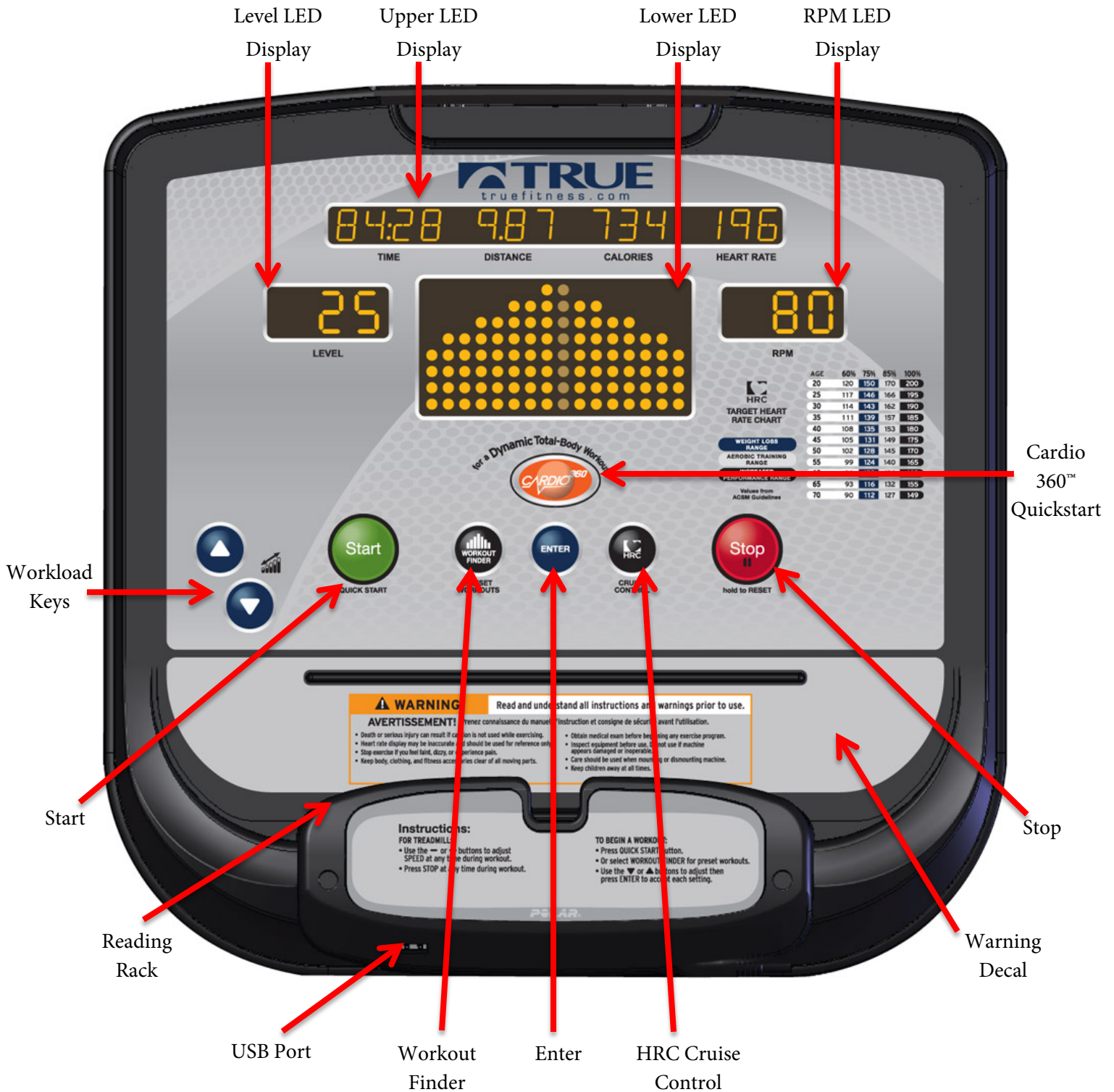

CHAPTER 4D: EMERGE OPERATION

EMERGE OVERVIEW (CONTINUED):

Workload Keys:

Manually increases or decreases the workout intensity.

Start:

Allows the user to begin a Quick Start workout or preset workout.

Reading Rack:

A ledge on the console can be used to hold a book, magazine, e-reader, or tablet computer during a workout.

USB Port:

Allows users to export workout data to an external USB drive or update the console software.

Workout Finder:

Pressing this button scrolls through available workouts. When the desired workout is displayed, the user must press Enter to input their data and start to begin the workout.

Enter:

Press this key to confirm a selection in a preset workout.

HRC Cruise Control:

Engages Heart Rate Control to allow the equipment to maintain the user's current heart rate through automatic workload adjustments (when the user is utilizing heart rate monitoring).

Warning Decal:

Important safety information for users to review prior to using the equipment.

Stop:

Stops/Pauses a workout. Press and hold this key for five seconds to reset the unit.

Cardio 360™ Quickstart:

Starts a 20 minute Cardio 360™ workout in which the user controls the workout intensity.

RPM and Level LED Displays:

These displays show the current Workload Level and RPM of the unit.

Lower LED Display:

Displays the workout profile of the current program.

Upper LED Display:

Shows the current workout data; Time, Distance, Calories and Heart Rate.

CHAPTER 4D: EMERGE OPERATION

CONSOLE NAVIGATION:

Selecting a Preset Workout:

To begin a preset workout, press the Workout Finder button (A) until the desired program is shown in the Upper LED Display (B) and then press the Enter button (C).

*To begin a Target HRC Workout, press the HRC Cruise Control button (D) followed by the Enter button (C)

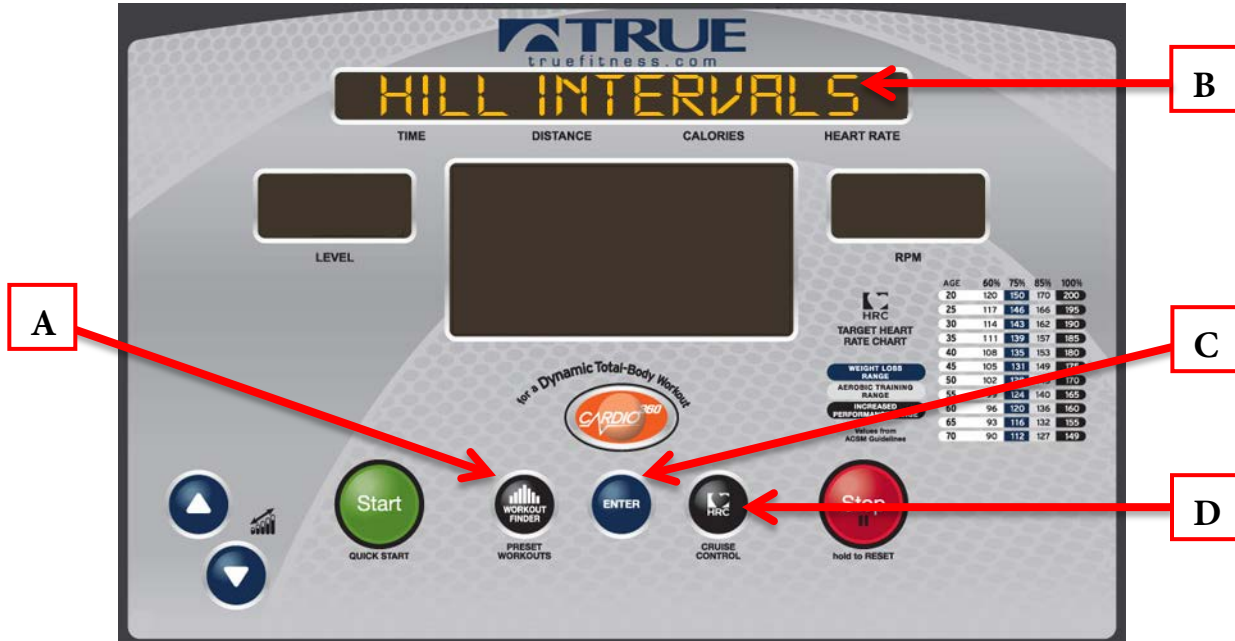

Workout Data Entry:

Before beginning a preset workout, the console will ask the user for information in order to give more accurate workout data. To adjust the Data Value (A), use the Up and Down Workload Keys (B). Once the desired value is displayed, press Enter (C) to move to the next Data Value. Once all data has been entered press Start (D) to begin the workout.

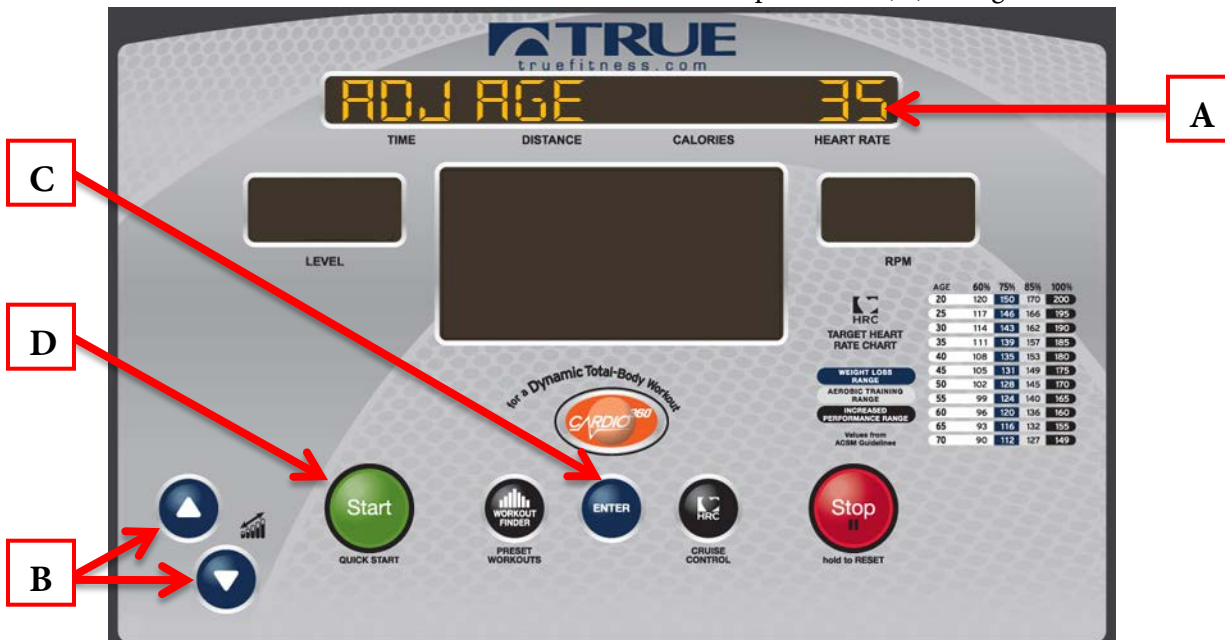

CHAPTER 4D: EMERGE OPERATION

CONSOLE NAVIGATION(CONTINUED):

Cardio 360™:

TRUE's unique Cardio 360™ is like having a personal trainer built in to the elliptical, walking users through a full-body workout. In just minutes, users will work their upper-body, lower-body and core. Plus, with the variety that Cardio 360™ brings, it will take the bore out of working out. The program walks users through the various movements they need to do to achieve the complete workout, so all they need to do is commit to stepping on the machine.

To Begin a Cardio 360™ workout, simply press the Cardio 360™ Quickstart Key (A) or use the workout finder (B) to select between multiple Cardio 360™ preset workouts.

Cardio 360™ workouts are broken down into workout segments in which the user is directed by the unit. The Upper LED Display (C) will provide the user with the instructions for the current workout segment.

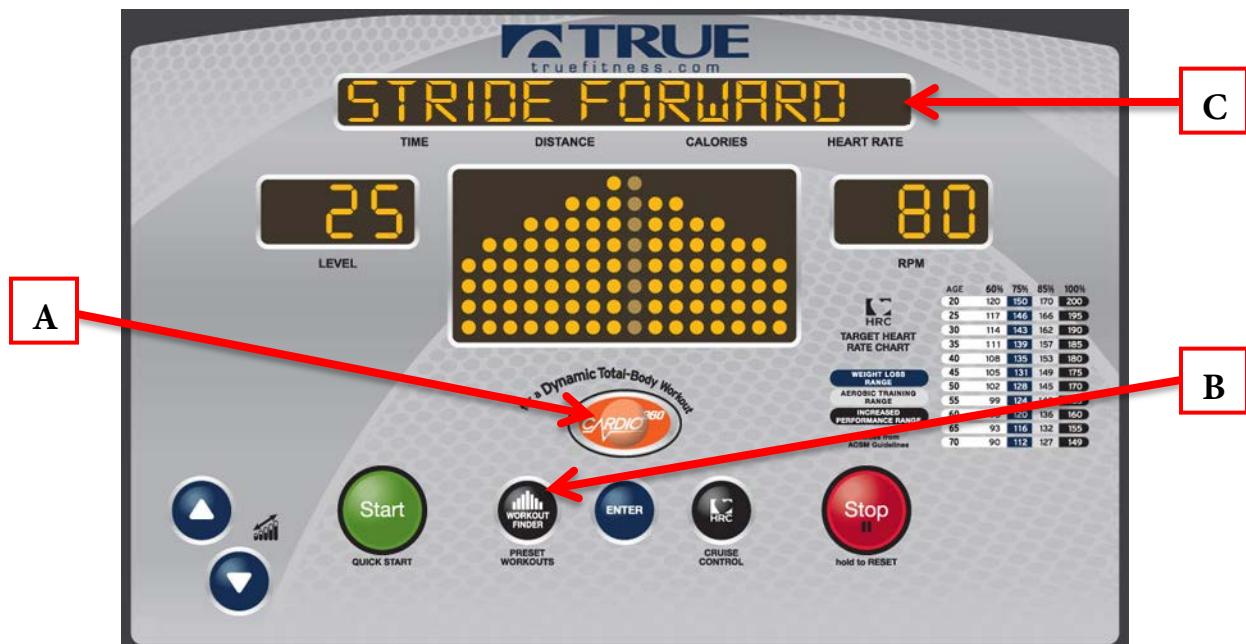

CHAPTER 4D: EMERGE OPERATION

CONSOLE NAVIGATION (CONTINUED):

Workout Summary:

Workouts can be ended by the user pressing the Stop button (A) or by completing the time or distance in a preset workout. Once a workout has ended the console will display a workout Summary which will give the user an overview of their workout which includes; Time, Average Heart Rate, Max Heart Rate, Average RPM, Max RPM, Distance and Calories. To Clear the Summary and return to the home screen press the Stop button (A).

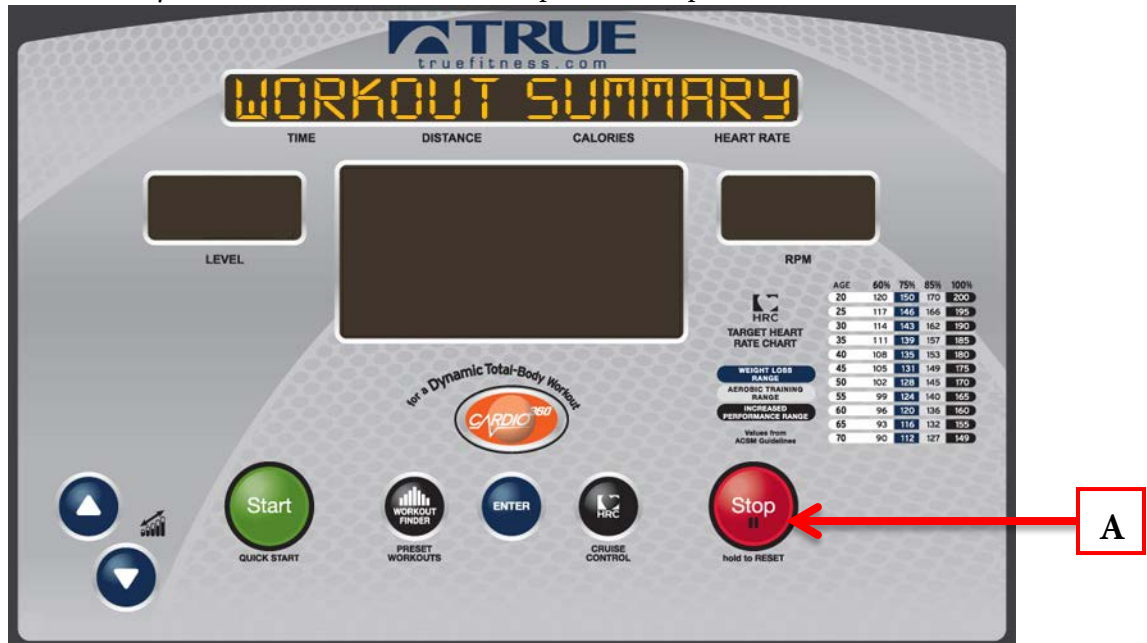

Exporting Workout Data to a USB Drive:

The Emerge Console gives users the ability to export their workout data to a USB drive. When this option is enabled the screen below will appear before the Workout Summary. To export the data, insert a USB drive into the console's USB port and press the Up Workload Key (A). To skip exporting the data, press the Down Incline Key (B) and the Workout Summary will be displayed without being exported.



CHAPTER 4D: EMERGE OPERATION

ADVANCED CONSOLE FUNCTIONS:

Entering Maintenance Mode:

Press and Hold the + Workload Button (A) until the unit beeps (about 3 seconds). Then release the + Workload Key and Immediately press and hold the Enter Button (B) until the unit beeps again (about 3 seconds). Then release the Enter button and when the Upper LED Display (C) reads "Maintenance Mode", press the Enter Button (B) to enter maintenance mode.



Maintenance Mode Navigation:

The Maintenance Mode is divided into two categories; Diagnostics and Configuration. To select a category use the + and - Workload Keys (A) until the category is listed in the Upper LED Display (B) and then press the Enter button (C).



CHAPTER 4D: EMERGE OPERATION

ADVANCED CONSOLE FUNCTIONS (CONTINUED):

Maintenance Mode Navigation (continued):

Within a category users can scroll through available options using the + and - Workload Keys (A). Once the desired setting is shown in the Upper LED Display (B), press the Enter Button (C) to confirm the selection. After confirming the selection, the + and - Workload Keys (A) are used to change the options within the setting. After changing any setting the Start Button (D) MUST be pressed to save the changes (if the start button is not pressed to save the changes, the setting will revert to the default value). The Stop Button (E) is used as a back button in Maintenance Mode and will take the user back one screen each time it is pressed. To exit the maintenance mode press the Stop Button (E) repeatedly until “Maintenance Mode” is displayed on the Upper LED Display (B) and then press and hold the Stop Button to reset the console or simply stop pedaling and allow the unit to completely power down.

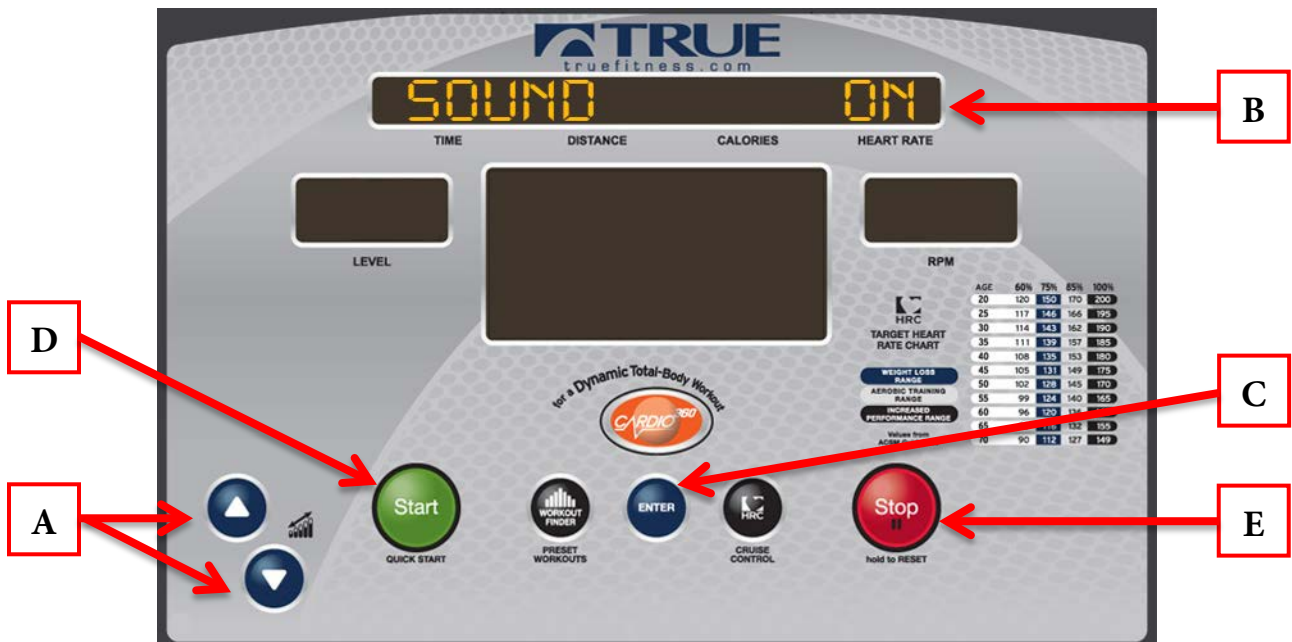

CHAPTER 4D: EMERGE OPERATION

ADVANCED CONSOLE FUNCTIONS (CONTINUED):

Diagnostics Menu:

The diagnostics menu contains various settings as well as tools used to help diagnose errors and performance issues.

<u>Title</u>	<u>Description</u>
<i>Total time:</i>	Displays an accumulative count of the total number of hours the unit has been used.
<i>Sound:</i>	Toggles the sound on or off.
<i>Default Weight:</i>	Allows users to change the default weight that appears when beginning a program.
<i>Show Watts:</i>	Toggles the watts display on or off.
<i>Max Time:</i>	Limits the amount of time that all workouts can last (does not apply to quickstart, manual or distance workouts).
<i>Power:</i>	Enables the use of an optional power supply.
<i>Pause Time:</i>	This setting will limit the amount of time that a workout can be paused before it automatically ends. By choosing the “Off” option, the unit will remain paused until the user resumes or ends the workout.
<i>Cooldown:</i>	Adjusts the length of the cooldown time at the end of a workout.
<i>USB Save:</i>	Enables or disables workout data exporting via the console’s USB port.
<i>Units:</i>	Changes between American Standard and Metric units.
<i>Average Speed:</i>	Will calculate the average speed used using the total hours and total miles collected in the other options.
<i>Total Distance:</i>	The total distance in miles that the unit has traveled.

CHAPTER 4D: EMERGE OPERATION

ADVANCED CONSOLE FUNCTIONS (CONTINUED):

Configuration Menu:

The configuration menu is used to make changes to the console & unit setup. This menu is also used for troubleshooting.

WARNING:

Misconfiguration of the console may cause damage to the unit and void the manufacturer warranty. If necessary, please contact TRUE Fitness Technical Support at 800-883-8783 for assistance.

<u>Title</u>	<u>Description</u>
<i>Model:</i>	Used to make changes to the model on which the console is installed.
<i>Display test</i>	Test Screens that Illuminate the LED's in the console display to ensure proper function.
<i>Key Test:</i>	Shows a description for any buttons that are pressed. In the event of a stuck key, the key that is being engaged will display.
<i>HR Test:</i>	Telemetry - Use a wireless heart rate strap or simulator to test if the unit is receiving wireless heart rate data. If there is a reading displayed without the use of a heart rate strap or simulator, there is outside interference from another source.
	Contact - Ensures the unit is receiving the data by displaying the user's heart rate when the contact heart rate pads are gripped.
<i>Cooldown:</i>	Adjusts the length of the cooldown time at the end of a workout.
<i>Total Distance:</i>	The total distance in miles that the unit has traveled.
<i>Total Time:</i>	Displays an accumulative count of the total number of hours the unit has been used.
<i>Max Watts:</i>	Displays the maximum power the unit is capable of producing.
<i>EPROM Test:</i>	Displays the current version of software installed on the console.

CHAPTER 4D: EMERGE OPERATION

ADVANCED CONSOLE FUNCTIONS (CONTINUED):

Software Update:

TRUE may periodically release software updates to ensure users enjoy the best workout experience available. To update the console software, download the update program (A) from truefitness.com and load the software to a blank USB drive by following the downloadable instructions.

***DO NOT place the installation program on the USB stick! The program must be run on a Windows based computer!**

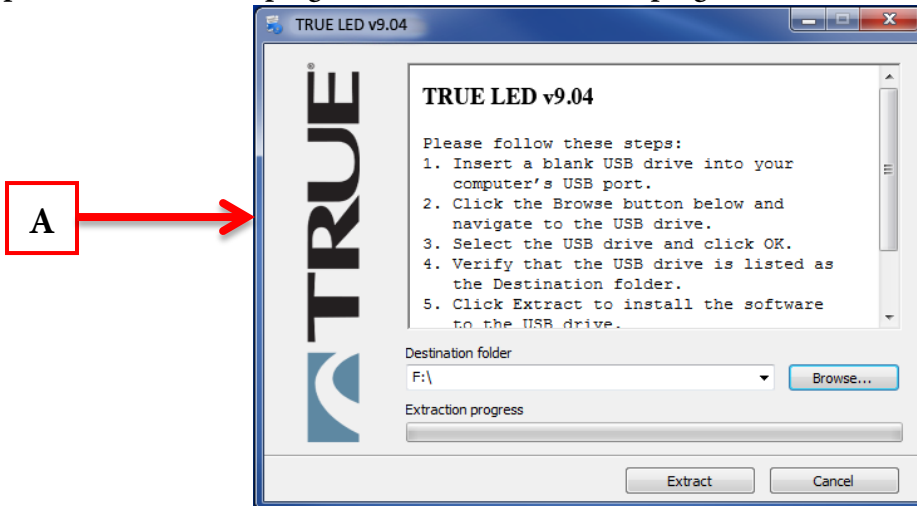

Software Installation Steps:

- Press and hold the Down Workload Key (A) while powering on the unit.
- When the upper LED display shows “CODE UPDATE” (B), insert the thumb drive into the console’s USB port and press the Enter key (C). *While the software is being updated, the LED displays will be blank.
- When the update is complete, the console will return to the home screen.

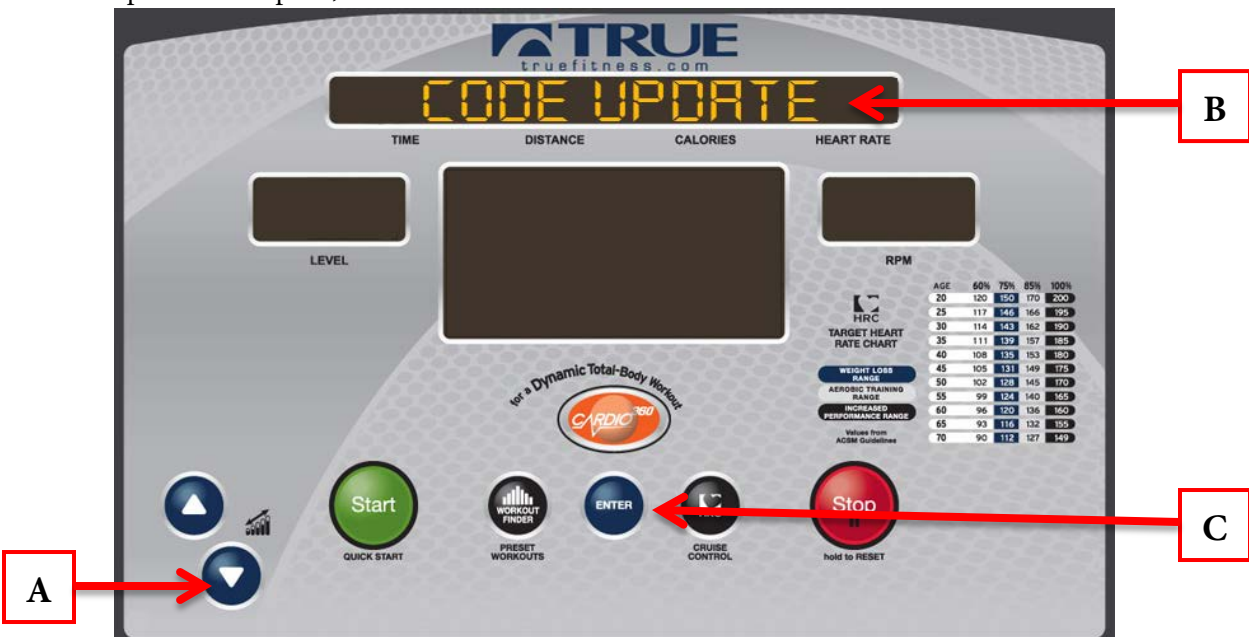

! WARNING:

Disconnecting the power source, switching the unit off or pressing buttons on the console will disrupt the information flow and potentially cause fatal errors.

CHAPTER 5: CARE & MAINTENANCE

CARE & MAINTENANCE:

It is important to perform the minor maintenance tasks described in this section. Failure to maintain the elliptical as described here could void the TRUE Fitness Warranty. To reduce the risk of electrical shock, always unplug the unit from its power source before cleaning or performing any maintenance tasks.

Inspection:

TRUE Fitness is not responsible for performing or scheduling regular maintenance or inspections.

Users should inspect the elliptical daily. Look and listen for slipping belts, loose fasteners, unusual noises, worn or frayed power cords, and any other indications that the equipment may be in need of service. If any of these are noticed, obtain service. Do not attempt to use the elliptical until proper service has been performed or damaged parts have been replaced.

Important:

If you determine that the elliptical needs service, make sure that the elliptical cannot be used inadvertently. Turn the unit off, and then unplug the power cord from its power source. Make sure other users know that the elliptical needs service.

To order parts or to contact a TRUE Authorized Service representative, please visit www.truefitness.com.

CLEANING THE EQUIPMENT:

After Each Use:

Use GymWipes™ Antibacterial wipes or spray a solution of 30 parts water to 1 part mild detergent to dampen a soft cloth and wipe all exposed surfaces.

Use a LCD/screen cleaner or spray a solution of 1 part 91% isopropyl alcohol and 1 part water to dampen a soft cloth and wipe the surface of the console. This helps remove fingerprints, dust, and dirt

Weekly:

Vacuum any dust or dirt that might have accumulated under or around the elliptical or any cover vents.

*Clogged air vents can prevent adequate cooling, causing a shortened life.

CAUTION:

Do not use any acidic cleaners. Doing so will weaken the paint or powder coatings and may void the TRUE Fitness Warranty. Never pour water or spray liquids on any part of the elliptical. Allow the elliptical to dry completely before using. Frequently vacuum the floor underneath the unit to prevent the accumulation of dust and dirt, which can affect the smooth operation of the unit.

CHAPTER 5: CARE & MAINTENANCE

OTHER SCHEDULED PREVENTIVE MAINTENANCE:

TRUE recommends that quarterly scheduled maintenance be performed by a qualified service technician. Please contact your dealer or visit www.truefitness.com to contact a local TRUE authorized service technician.

Scheduled Preventive Maintenance:

- Check error log in console.
- Remove shroud covers and vacuum any debris out of the speed sensor, control electronics and moving parts.
- Move unit and vacuum underneath.
- Check belt tension and tracking.
- Inspect all fasteners.
- Inspect all electrical connections.
- Inspect all components for abnormal or premature wear.

CAUTION:

Use only TRUE Fitness certified service providers.

LONG TERM STORAGE:

When the elliptical is not in use for any length of time, turn it off. Make sure that the power cord is unplugged from the power source and is positioned so that it will not become damaged or interfere with people or other equipment.

Storing the Chest Strap:

Store the chest strap in a place where it remains free of dust and dirt such as, in a closet or drawer. Be sure to protect the chest strap from extremes in temperature. Do not store it in a place that may be exposed to temperatures below 32° F (0° C). To clean the chest strap, use a sponge or soft cloth dampened in mild soap and water. Dry the surface thoroughly with a clean towel.

CHAPTER 6: CUSTOMER SERVICE

CONTACTING SERVICE:

TRUE Fitness recommends that you gather the serial number, model number, and a brief description of the reason for the request. After information has been gathered you may choose to contact your selling dealer or local service company to set an appointment. (If you are not familiar with who is in your area, you may visit our website at www.truefitness.com and use our dealer locator to obtain the contact information for the closest dealer).

You may also contact TRUE Fitness' customer support team by calling 800.883.8783 or e-mailing us at service@truefitness.com Monday – Friday during normal business hours.

TRUE FITNESS SERVICE DEPARTMENT

865 HOFF ROAD

ST. LOUIS, MO 63366

1.800.883.8783

HOURS OF OPERATION: 8:30 A.M. - 5:00 P.M. CST

E-MAIL: service@truefitness.com

CONTACTING SALES:

Interested in TRUE Products? Please contact us with any sales or product inquires so that we may direct you to the appropriate sales representative to answer your questions.

TRUE FITNESS HOME OFFICE

865 HOFF ROAD

ST. LOUIS, MO 63366

1.800.426.6570

HOURS OF OPERATION: 8:30 A.M. - 5:00 P.M. CST

E-MAIL: sales@truefitness.com

CHAPTER 6: CUSTOMER SERVICE

REPORTING FREIGHT OR PARTS DAMAGE:

Unfortunately, sometimes materials can be damaged during shipment. If materials are damaged during shipment, please follow the guidelines below to determine the appropriate process for you to follow in case of damages.

Severe Damage:

Obvious damage to external packaging / internal product. Please **refuse** the shipment and it will be returned to TRUE Fitness by the carrier. Contact the TRUE Fitness customer support team by calling 800.883.8783 or sales support team by calling 800.426.6570 Monday-Friday during normal business hours to notify us that the shipment has been refused. Once we have received the damaged shipment, a replacement shipment will be sent to you. Only refuse the damaged piece if the shipment is multiple boxes.

Slight Damage:

The box may have minimal damages and you are not sure if the actual product is damaged or not. You **must** sign the bill of lading as damaged when accepting the shipment. Once you have opened the box and you have determined something is indeed damaged please gather the serial number, model number, description and photos of damages. Please make sure the photos include the damaged product as well as the damaged box the product arrived in. Contact the TRUE Fitness customer support team by calling 800.883.8783 or sales support team by calling 800.426.6570 Monday-Friday during normal business hours.

Concealed Damage:

You may receive a shipment that looks intact and discover once the box has been opened that there are hidden damages. Please notify the carrier **immediately**. We will not be able to file a claim if the carrier is not notified in a timely manner. Once you have called the carrier you will need to gather the serial number, model number, description and photos of damages. Contact the TRUE Fitness customer support team by calling 800.883.8783 or sales support team by calling 800.426.6570 Monday-Friday during normal business hours.

CHAPTER 7: ADDITIONAL INFORMATION

TROUBLESHOOTING GUIDE:

This troubleshooting guide is intended to assist in diagnostics only and is not all inclusive. Technical specifications, error codes and programming are subject to change without notice. TRUE accepts no liability for any damage or loss suffered by persons whom rely wholly or in part on any description or statement contained within this manual. Please visit www.truefitness.com to obtain the most recent version of all manuals and contact the TRUE Service Department at 800-883-8783 for assistance with troubleshooting and diagnostics.

Malfunction	Possible Cause	Corrective Action
No Power	Unit is turned off	Verify the On/Off switch is at the ON position (If applicable)
	Damaged power cord	Replace power cord
	Power cord not fully seated in socket	Inspect power connection at the unit and outlet
	No power at wall outlet	Use a voltmeter to verify power at wall outlet
	Optional ERP board damaged	Contact TRUE Fitness Customer Service Department (If applicable)
	Battery is discharged	Charge the battery overnight with optional power supply
	Motor control board damaged	Contact TRUE Fitness Customer Service Department
Unit resets or pauses randomly	Damaged power cord	Replace power cord
	Power cord not fully seated in socket	Inspect power connection at the unit and outlet
	Insufficient power	Verify output voltage from 20A outlet with a voltmeter
	Error code is displayed on console	Contact TRUE Fitness Customer Service Department
	Speed sensor out of alignment	Contact TRUE Fitness Customer Service Department
	Pinched or loose main communication cable	Contact TRUE Fitness Customer Service Department
Resistance hesitates or slips when pedaling	Loose belt tension	Contact TRUE Fitness Customer Service Department
Rubbing or knocking sound from unit when in operation	Uneven floor	Adjust equipment with leveling feet.
	Loose hardware	See Chapter 5: inspections
	Loose Pedal	See Chapter 5: inspections
	Bearings may be damaged	Contact TRUE Fitness Customer Service Department
	Brake assembly may be damaged	Contact TRUE Fitness Customer Service Department
	Drive belt may be misaligned	Contact TRUE Fitness Customer Service Department
No TV displayed or low quality	Low or bad video signal	Contact video provider
		NTCS dBmV 0 through 15.6 ATCS/QAM dBmV-10 through 15.5
	Loose F type connector (coaxial cable)	inspect all connections
	Encrypted video	Obtain set top box from video provider
	Channels or format type not correct	Verify video type with provider; analog (NTCS), digital air (ATCS), digital cable (QAM)
		Rescan TV channels
Tuner Invalid	Contact TRUE Fitness Customer Service Department	

CHAPTER 7: ADDITIONAL INFORMATION

TROUBLESHOOTING GUIDE (CONTINUED):

Heart rate is displaying erratically or not displaying	Transmitter belt contacts are not making good contact with the skin	Re-adjust the transmitter belt so that it is in full contact with the skin
	Contacts on the transmitter belt are not moist	Moisten the contacts on the transmitter belt
	Transmitter belt is not within 3 feet (1 meter) of the heart rate receiver	Adjust your position on the belt so that you are within 3 foot (1 meter) of the console
	Transmitter belt is not the correct frequency or is encoded	Polar equip or compatible receiver use 4.8kHz un-encoded receiver
	The battery inside the transmitter belt is depleted	replace the transmitter belt with a compatible transmitter belt
	Another user wearing a compatible transmitter strap is within 3 foot (1 meter) of the unit	Move the units so that there is more space in-between units
	Environmental interference from high voltage power lines	Move the unit to another position within the room or move the cause of the interference until heart rate reading are stable. If the probable source of interference is plugged into the same outlet move the suspect source to another outlet.
	Environmental interference from computers	
	Environmental interference from motor driven appliances	
	Environmental interference from cell or cordless phone	
	Environmental interference from Wi-Fi router	

Fault Code	Category	Description	Cause	Corrective Action
Fault CN00: Corrupted Console Configuration	Console	Corrupted brainboard configuration - fails integrity check	Corrupt software	Power cycle Re-configure console
			Firmware and software versions are not compatible	Re-install software/firmware Contact dealer or TRUE service
Fault CN01: Internal Fault	Console	Math error - software	Console configured incorrectly	Power cycle Re-configure console
			Corrupt Software	Re-install software/firmware Contact dealer or TRUE service

CHAPTER 7: ADDITIONAL INFORMATION

TROUBLESHOOTING GUIDE (CONTINUED):

Fault CN02: Invalid Console Configuration	Console	The product configuration data has failed validation checks (incline ranges make no sense, etc.)	Console configured incorrectly	Power cycle
				Re-configure console
			Incline motor out of range	Contact dealer or TRUE service
Loose cable				
Fault CN03: Stuck Key	Console	Membrane Key stuck down/closed	Membrane key is damaged	Contact dealer or TRUE service
Fault CN04: Lower Board Comm Fault (Treadmill Only)	Console	Brainboard fails to receive timely communication responses from lower board - Fault after 3 retries	Unit is configured as a treadmill	Re-configure console
Fault CN05: No Lower Control	Console	No lower board connected to console - detection wires not connected.	Loose cable	Power cycle
				Check cable connections
			Console configured incorrectly	Reconfigure console
Fault CN06: Config Mismatch	Console	Console is configured for a product different than that to which it is connected.	Console configured incorrectly	Power cycle
				Re-configure console
			Loose cable	Check cable connections
Fault CN07: Calibration Timeout	Console	Incline Calibration was not able to complete within allowed time.	Unit is configured as a treadmill	Re-configure console
Fault CN08: Calibration Failed - Lower Limit Not Reached	Console	During incline calibration, the incline stalled before reaching what should be the lower limit.	Unit is configured as a treadmill	Re-configure console
Fault CN09: Insert Safety Key	Console	Emergency Circuit opened	Unit is configured as a treadmill	Re-configure console
Fault CN10: E-Stop Fault	Console	A test of the emergency circuit has failed	Unit is configured as a treadmill.	Re-configure console
Fault CN24: BB Comm Fault	Console	SBC cannot communicate with Brainboard	Console	Power cycle
				Contact dealer or TRUE service
Fault CN25: Firmware Mismatch	Console	Firmware on brainboard not compatible with SBC software	Corrupt software	Power cycle
				Reconfigure Console
			Firmware and software versions are not compatible	Re-install software/firmware
				Contact dealer or TRUE service

TRUE[®] CARDIO

XC900

COMMERCIAL



PREMIUM FITNESS EQUIPMENT SINCE 1981

XC900 ELLIPTICAL

Sleek. Sexy. Superior. That's the XC900 Elliptical from TRUE. This elliptical design is sure to turn heads and keep them coming back to your facility for more. TRUE continues the tradition of high quality craftsmanship with the XC900. The XC900 Elliptical offers TRUE's patented Core Drive system that provides the most natural movement and keeps the user in the center of the exercise motion for superior balance, stability and comfort. Plus, with TRUE'S Cardio 360TM programming and patented side steps users can get a total body workout in as little as twenty minutes.



XC900 ELLIPTICAL

TECHNICAL SPECIFICATIONS	Power Source	110V, Self-Generating (with Emerge or Escalate [®]), 220V Option Available (with Transcend or Escalate [®])
	Cord Length	12' / 3.7 M
	Drive System	Core Drive™
	Total Body Workout	Cardio 360™
	Resistance Source	Hybrid Self-Generating Brake
	Maximum Workload	600 Watts
	Frame Construction	Robotically Welded Heavy-Gauge Steel
	Stride Length	21" / 53 cm
	Footpad	Soft Step Cushioned Anti-Fatigue Material
	Exercise Arms	Ergonomic Handles with Moisture Resistant Sleeves
	Handrail Design	Extended Handrails with Molded Rubber, Moisture Resistant Grips
	Side Step Design	Brushed Aluminum with Textured Pattern
	Contact Heart Rate Monitoring	Yes
	Wireless Heart Rate Monitoring	Polar® Compatible
	AVAILABLE CONSOLES	Transcend ¹⁶ , Escalate ¹⁵ , Escalate ⁹ , Emerge
Cardio 360™	Upper Body Isolation	Yes
	Lower Body Isolation	Yes
	Total Body	Yes
SAFETY	Side Steps	Standard
	Extended Handrails	Standard
	Activity Guard (removable)	Standard
REGULATORY APPROVALS	ETL UL1647, CSA, CE, EN957, FCC	
EXTRAS	Accessories	Water Bottle Holder, Accessory Tray, Over Molded Reading Rack/Tablet Holder
PHYSICAL SPECIFICATIONS	Footprint	67" L x 34" W x 64" H / 170 cm x 86 cm x 163 cm
	Active Footprint	73" L x 34" W x 64" H / 186 cm x 86 cm x 163 cm
	Q-Factor	1.9" / 4.8 cm
	Machine Weight	375 lbs / 170 kg
	Shipping Weight	423 lbs / 192 kg
	Maximum User Weight	400 lbs / 181 kg
	Step-Up Height	7" / 18 cm
Portability	2 Front Transport Wheels	
WARRANTY	Warranty Classification	Commercial (all dues paying facilities, regardless of usage)
	Frame	Lifetime
	Parts	3 Years
	Labor	3 Years

Warranties outside the U.S. and Canada may vary - Please contact your dealer for details. Specifications subject to change without notice.



CHAPTER 7: ADDITIONAL INFORMATION



COMMERCIAL LIMITED WARRANTY XC900 ELLIPTICAL

Save Time and Register Online!
Activate Multiple Warranties at truefitness.com/support

All TRUE® Fitness products are distributed by TRUE and are warranted to the original registered product purchaser and the parts of the TRUE product (the "Product") listed below, under normal use and service, shall be free of manufacturing defects in workmanship and materials only for the period of time beginning from the original date of purchase set forth below:

Frame*	Lifetime
Parts	
Transcend Touchscreen	3 Years
Escalate ¹⁵ Console	3 Years
Electrical	3 Years
Wear Items	3 Years
Cosmetics	6 Months
Labor	
Parts	3 Years
Cosmetics	6 Months
iPod® Connectivity	
Headphone Jack, Connector & USB Port	90 Days Parts, No Labor

NOTE: Warranty valid for USA and Canada only.
NOTE: Failure to register this product will result in no servicing or authorization of parts to be shipped.
NOTE: Buying after-market products from a 3rd party will result in voided warranty.
NOTE: This product is intended for Commercial use which includes facilities where usage is in excess of 8 hours per day. This includes all dues-paying facilities (regardless of usage) as well as many non-dues-paying facilities. If this product will not be used in this particular setting, please contact TRUE as this warranty is void.

Frame: The frame is warranted for defects in material and workmanship for as long as the original purchaser owns the Product. The frame is warranted for labor and freight (for parts shipped from TRUE) for two years from date of purchase. * This limited warranty on structural frame does not include paint or coatings.

Parts: The elliptical electrical parts and wear items are warranted for defects in material and workmanship for Three years with two years labor warranty. The Transcend touchscreen and Escalate¹⁵ console are warranted for defects in material and workmanship for three years with three years labor warranty. This limited warranty does not cover

damage or equipment failure resulting from or caused by improper assembly/installation, failure to follow instructions and warnings in owner's manual, accident, misuse, abuse, unauthorized modification, or failure to provide reasonable and necessary maintenance. *TRUE Fitness shall not warrant the performance of the heart rate system on its products, as the heart rate system performance varies, based on user's physiology, age, method of use and other factors. * This limited warranty shall not apply to software version upgrades.

Cosmetics: The elliptical cosmetic parts are warranted for defects in material and workmanship for six months with labor warranty to match the parts warranty period. This limited warranty does not cover damage or equipment failure resulting from or caused by improper assembly/installation, failure to follow instructions and warnings in owner's manual, accident, misuse, abuse, unauthorized modification, or failure to provide reasonable and necessary maintenance. This limited warranty will apply to but may not be limited to plastic covers, shrouds, caps, badges, overlays, paint, coatings, soft step inserts and grips.

iPod Connectivity: iPod Connectivity elements; headphone jack, connector and USB Port are warranted for defects in material and workmanship for 90 days with no labor warranty.

Labor: Labor is covered for a period of three years from the date of purchase unless otherwise expressed within this limited warranty as long as a TRUE authorized service provider performs the service. Service that requires over 50 miles of travel may be subject to additional charges. Reasonable and necessary maintenance guidelines can be found in the owner's manual.

Claims Procedure: TRUE Limited Warranty service may be obtained by contacting the authorized TRUE dealer from whom the Product was purchased. If the dealer from whom the Product was purchased is no longer an authorized TRUE dealer, then TRUE Limited Warranty service may be obtained by contacting TRUE directly at:

TRUE Fitness, Service Department
865 Hoff Road, St. Louis, MO 63366
1.800.883.8783
Hours of operation 8:30am - 5:00 pm CST

CHAPTER 7: ADDITIONAL INFORMATION



COMMERCIAL LIMITED WARRANTY XC900 ELLIPTICAL

Save Time and Register Online!
Activate Multiple Warranties at truefitness.com/support

1. This Limited Warranty can be processed only if the Warranty Registration Form is completed on-line; or if the attached form is filled in, signed by the original purchaser and mailed to TRUE within 30 days of purchaser's receipt of this Product. The serial number must be intact on the Product for this Limited Warranty to be valid.
 2. This Limited Warranty applies to the product only while the Product remains in the possession of the original purchaser and is not transferable.
 3. This Limited Warranty becomes VALID ONLY if the Product is initially assembled/installed by a TRUE authorized dealer/ technician (if anyone other than a TRUE authorized dealer/ technician initially assembles and installs the Product, this Limited Warranty will be void unless the written authorization of TRUE is first obtained).
 4. This Limited Warranty does not cover damage or equipment failure resulting from or caused by improper assembly/ installation, failure to follow instructions and warnings in owner's manual, accident, misuse, abuse, unauthorized modification, or failure to provide reasonable and necessary maintenance (as referenced in the owner's manual.)
 5. This Limited Warranty applies only to the cost of repair or replacement of parts and does not include labor (beyond the above warranty period), transportation, service, return and freight charges associated therewith expressly specified herein.
 6. This Limited Warranty shall not apply to: Service calls to correct installation of the equipment or instruction to owners on how to use the equipment; or any labor costs incurred beyond the applicable labor warranty period.
 7. This Limited Warranty is in lieu of all warranties, express or implied, and in lieu of all other obligations or liabilities on the part of TRUE, under no circumstances shall TRUE be liable by virtue of this Limited Warranty or otherwise from damage to any person or property whatsoever for any special, indirect, incidental, secondary or consequential losses, damages or expenses in connection with exercise products.
- Any implied warranty is limited in duration to the time period covered by the Limited Warranty. Some states do not allow limitations on how long an implied warranty lasts, or the exclusion may not apply to you. This Limited Warranty grants you specific legal rights and you may also have other rights, which vary from state to state.

NOTE TO AUTHORIZED WARRANTY LABOR PROVIDERS:
Warranty labor reimbursement or warranty parts rights may not be transferred to, reassigned to, a third party without the express written consent of TRUE. Even jobbing out warranty labor requires TRUE's written approval.

CS900 ELLIPTICAL SERIAL NUMBERS:

The CS900 elliptical comes with two serial numbers; one on the base and one on the display console (see diagram below). The serial number on the base is located on the front inside sheet metal on the bottom right hand side. The console serial number is located on the bottom right side of each console. Please write down your serial numbers below and keep for your records.

CONSOLE SERIAL NUMBER:

BASE SERIAL NUMBER:



SAMPLE SERIAL NUMBER STICKER:

TRUE FITNESS TECHNOLOGY, INC.
ST LOUIS, MISSOURI 63366

Intertek
3110024

CONFORMS TO ANSI/UL
STD. 1647
CERTIFIED TO CAN/CSA
STD. C22.2 NO.68

Intertek Testing Services Taiwan Ltd.

Model No.
XC900

Serial No./Date Code
17-XC9000001A

Rating:
120Vac, 0.5amp, 35watts, 60Hz, 10
MADE IN TAIWAN

Keep this page for your records

CHAPTER 7: ADDITIONAL INFORMATION



COMMERCIAL LIMITED WARRANTY XC900 ELLIPTICAL

Thank you for purchasing a TRUE product. To validate the TRUE product warranty the fast and easy way, please go on-line now to truefitness.com/support and register your product. The information you provide will never be distributed to any other individuals or agencies for any purpose. If you prefer to mail your warranty card, have the owner of the product complete the information below and return it to TRUE Fitness within 30 days from the date of equipment installation.

To mail your warranty information, please fill in the information below and mail to: Service Dept., TRUE Fitness, 865 Hoff Road, St. Louis, MO 63366 (or save postage and register online at truefitness.com)



Commercial Warranty Registration

**PLEASE PROVIDE BOTH SERIAL NUMBERS BELOW.
REQUIRED FOR WARRANTY REGISTRATION:**

CONSOLE SERIAL NUMBER:

BASE SERIAL NUMBER:

Model Type: CS900 Commercial Elliptical

Date of Purchase _____

Your Company Name _____

Contact First Name _____

Contact Last Name _____

Address _____

City _____ State _____ ZIP _____

Email Address _____

Phone _____ Fax _____

1. Where did you first learn about TRUE?

- a. Dealer b. Website
 c. Advertisement d. Referral
 e. Current Customer f. Other _____

2. Why did you purchase a TRUE product?

- a. Design/Appearance b. Dealer Suggestion
 c. Price/Value d. Quality Construction
 e. Performance f. TRUE Reputation
 g. Other _____

3. Please indicate your type of facility:

- a. Apartment/Condo b. Corporate Fitness Center
 c. Municipality d. Health Club/Gym/Spa
 e. Hotel/Resort f. Military Base
 g. Student Rec Center h. Other

4. What other types of equipment does your company currently own?

- a. Treadmill Brand _____
 b. Bike Brand _____
 c. Elliptical Brand _____
 d. Free Weights/Gym Brand _____

5. How many people use your facility on a daily basis?

- a. <25 b. 25-75
 c. 76-150 d. 150+

6. Do you plan to purchase more fitness equipment in the next 6-12 months?

- Yes No

7. If you answered "yes" to question 6, what type do you plan to purchase?

- a. Treadmill b. Elliptical
 c. Stationary Bike d. Free Weights
 e. Gym f. Other _____

8. Would you recommend TRUE to other club owners?

- Yes No

9. You are a valued TRUE customer and your suggestions allow us to continually improve your experience. Is there anything else you would like us to know? Please explain:

truefitness.com / 800.426.6570 / 1.636.272.7100